

---

# What'sBest!®

Version 13.0

## User's Manual

*Taking your spreadsheet beyond "What If?"*

1415 North Dayton Street, Chicago, Illinois 60642 USA

Phone: (312) 988-7422 Fax: (312) 988-9065

[info@lindo.com](mailto:info@lindo.com)

[www.lindo.com](http://www.lindo.com)

---

---

## **COPYRIGHT**

The *What'sBest!*® software and its related documentation are copyrighted. You may not copy the *What'sBest!*® software or related documentation except in the manner authorized in the related documentation or with the written permission of LINDO Systems Inc.

## **TRADEMARKS**

*What'sBest!*® and LINDO are registered trademarks of LINDO Systems Inc. Other product and company names mentioned herein are the property of their respective owners.

## **DISCLAIMER**

LINDO Systems Inc. warrants that on the date of receipt of your payment, the enclosed computer media contains an accurate reproduction of the *What'sBest!*® software and that the copy of the related documentation is accurately reproduced. Due to the inherent complexity of computer programs and computer models, the *What'sBest!*® program may not be completely free of errors. You are advised to verify your answers before basing decisions on them. NEITHER LINDO SYSTEMS INC. NOR ANYONE ELSE ASSOCIATED IN THE CREATION, PRODUCTION, OR DISTRIBUTION OF THE *WHAT'SBEST!*® SOFTWARE MAKES ANY OTHER EXPRESSED WARRANTIES REGARDING THE DISKS OR DOCUMENTATION AND MAKES NO WARRANTIES AT ALL, EITHER EXPRESSED OR IMPLIED, REGARDING THE *WHAT'SBEST!*® SOFTWARE, INCLUDING THE IMPLIED WARRANTIES OF MERCHANTABILITY, FITNESS FOR A PARTICULAR PURPOSE OR OTHERWISE. Further, LINDO Systems Inc. reserves the right to revise this software and related documentation and make changes to the content hereof without obligation to notify any person of such revisions or changes.

## **ACKNOWLEDGEMENTS**

We gratefully acknowledge Professor Sam Savage for his contributions to early releases of *What'sBest!*®.

Copyright © 2014, LINDO Systems, Inc.

Published by

1415 North Dayton Street  
Chicago, Illinois 60642  
USA

Sales & Information: (312) 988-7422

*info@lindo.com*

Technical Support: (312) 988-9421

*tech@lindo.com*

*www.lindo.com*

---

---

# Contents

---

CONTENTS.....	III
PREFACE .....	XIII
Other Valuable Features .....	xv
<b>1 GETTING STARTED WITH WHAT'SBEST!.....</b>	<b>1</b>
What is What'sBest! ?.....	1
Optimization Models .....	2
Non-Optimization Models.....	2
Models with Integer Restrictions.....	2
System Requirements .....	3
Installation Overview.....	4
The What'sBest! Interactive Environment .....	7
Developing a Model in What'sBest!.....	9
The ABC's: Three Steps to What'sBest! .....	9
TUTORIAL .....	10
The XYZ Production Problem .....	10
The ABC's .....	12
What's Best If .....	18
Working While Solving .....	19
The Next Step .....	19
<b>2 ABC'S: THE BASICS OF WHAT'SBEST!.....</b>	<b>21</b>
Adjustable.....	22
Make Adjustable.....	22
Remove Adjustable .....	23
Make Adjustable & Free or Remove Free .....	23
Free.....	24
Best.....	25
Objective .....	25
Cell range.....	26
Constraints.....	27
Left Hand Side (LHS);, Right Hand Side (RHS);, and Stored in: .....	27
Usage Guidelines for Constraints .....	29
Constraint-related Problems .....	31
Explicitly Specifying Convexity to the Solver .....	32
Solve.....	33
Getting the Best Results .....	36
<b>3 ADDITIONAL COMMANDS .....</b>	<b>41</b>
Options and Solvers .....	41
Integers... Integer-Binary.....	43
Integer Names in Workbook .....	44
Refers to.....	44
Binary-WBBIN .....	44
General-WBINT.....	44

---

---

Runtime Concerns in Integer Problems .....	44
Integers... Special Ordered Set.....	45
Special Ordered Set.....	45
Cardinality .....	46
Select Any Cells .....	47
List of Selected Cells .....	47
Place the Function in Cells .....	47
Integers... Semi-continuous .....	48
Select Any Cells .....	49
List of Selected Cells .....	49
Place the Function in Cells .....	49
Options... ..	50
Options... General.....	51
Feasibility Tolerance .....	52
Iteration Limit.....	52
Runtime Limit .....	52
Constraint Display.....	52
Auto Select Free/Int/Omit Ranges .....	53
Minimize Excel® on Solve .....	53
Hide Status Window on Solve.....	54
Linearization.....	54
Delta Coefficient.....	54
Big M Coefficient.....	54
Status Report .....	55
Solution Report .....	55
Beginning or End.....	56
Warnings .....	57
Update Links .....	57
Delete Reports .....	58
Options... Linear Solver .....	58
Scale Model .....	59
Model Reduction .....	59
Solver Method .....	59
Pricing .....	59
Options... Nonlinear Solver.....	61
Crash Initial Solution / Use LINDO Crash .....	61
SLP Direction .....	62
SLP Solver .....	62
Quadratic Recognition .....	62
Presolve .....	62
Selective Constraint Evaluation .....	62
Steepest Edge.....	63
Starting Point.....	63
Optimality Tolerance .....	63
Iteration Limit for Slow Progress .....	64
Derivatives .....	64
Options... Global Solver.....	65

---

Global Solver.....	66
Multistart Attempts .....	66
Optimality .....	66
Delta.....	66
Variable Bound.....	67
Use of Bound .....	67
Branching Direction.....	67
Box Selection .....	67
Algebraic Reformulation.....	67
Options... Integer Pre-Solver .....	68
Heuristics Level.....	69
Heuristics Cutoff Criterion .....	69
Probing Level .....	69
Constraint Cuts .....	71
Options... Integer Solver .....	73
Branching Direction.....	74
Integrality.....	74
LP Solver.....	75
Optimality .....	76
Tolerances .....	77
Usage Guidelines for K-Best Solutions .....	82
Options...  Stochastic Solver .....	88
Stochastic Modeling Support .....	88
Page Step 1 "core model" .....	89
Page Step 2 "sequencing" .....	90
Page Step 3 "distributions or correlations" .....	92
Page Step 4 "scenario sampling".....	95
Page Reports .....	97
Use Preview Window for Scenario Selection.....	104
Page Chance-Constrained.....	105
Frame Specifications .....	106
Use Simulation Format .....	108
Options... Reset to Default.....	109
Advanced... Dual... .....	110
For Cell Range .....	111
Report on Type .....	111
Dual Value.....	111
Upper Range and Lower Range .....	111
Report Information in .....	111
Usage Guidelines for Dual Values.....	112
Dual Value of a Constraint Cell - Shadow Price .....	112
Dual Value of an Adjustable Cell - Reduced Cost .....	114
Dual Value of Zero and Multiple Optima .....	117
Dual Values in Nonlinear Problems .....	117
Dual Values in Integer Problems .....	117
Valid Ranges for Dual Values .....	117
Constraint Ranges .....	118

---

Adjustable Cell Ranges .....	120
Advanced... Omit.....	124
OMIT Names in Workbook and Refers to .....	124
Usage Guidelines for Omit .....	125
What To Omit .....	125
What Not To Omit .....	125
Advanced... Function Support .....	126
Function Support.....	126
Advanced... Statistical Functions .....	127
Advanced... String Support.....	127
String Support .....	127
Maximum String Length .....	128
Advanced... Convert Model Format .....	128
Advanced... Parameters .....	129
Locate.....	132
Help & About What'sBest! .....	133
Toolbar / Ribbon Bar.....	135
License Key Entry.....	136
Register.....	138
CheckUpdate.....	139
Language .....	141
<b>4 WHAT'SBEST! MACROS: THE VBA INTERFACE .....</b>	<b>143</b>
Usage Guidelines for Macros in VBA .....	143
Introduction to the VBA Interface of What'sBest!.....	143
Object Browser.....	143
Macro Recorder .....	144
Calling Procedures.....	144
Error messages you might encounter learning VBA.....	145
Beyond VBA / VB.....	145
Embedding What'sBest! in a Visual Basic® / Visual Studio® Project .....	145
Concealing and Protecting a Model from the User .....	146
Tutorial on the VBA Interface .....	147
Building and Solving a Basic Model.....	147
Solving Multiple Problems with a Looping Macro .....	150
VBA Interface: Procedures .....	151
wbAddAdjustableStyle .....	152
wbAddBestStyle .....	152
wbAddWBMenu .....	152
wbAdjust.....	153
wbBest .....	154
WBBIN .....	155
wbConstraint .....	156
wbDeleteReports.....	158
wbDeleteWBMenu .....	158
wbDualValue .....	159
wbError, and Error Codes .....	160
wbError.....	162

---

WBFREE .....	168
WBINT .....	169
wbInteger .....	170
wbIntegerCard .....	171
wbIntegerSemic .....	172
wbIntegerSos .....	173
wbIntegerSolverKBestReport .....	174
WBOMIT .....	175
wbResetOptionsToDefault .....	176
wbSetFunctionSupport .....	176
wbSetGeneralOptions .....	177
wbSetGlobalOptions .....	181
wbSetIntegerOptions .....	183
wbSetIntegerPreSolverOptions .....	186
wbSetLinearOptions .....	189
wbSetNonlinearOptions .....	190
wbSetStochasticOptions .....	193
wbSetStochasticSupport .....	195
wbSetStringSupport .....	195
wbSolve .....	196
wbStochasticChanceConstrained .....	198
wbStochasticFunction .....	200
wbStochasticHistogram .....	201
wbStochasticReport .....	202
wbStochasticStageScenario .....	203
wbUpdateLinks .....	204
<b>5 FUNCTIONS AND OPERATORS .....</b>	<b>205</b>
List of Supported Functions and Operators .....	205
Functions .....	205
Operators .....	205
Distributions/Correlations for Stochastic Programming .....	206
Linearization .....	207
Global Solver .....	207
Statistical Functions .....	208
1. Erlang's Loss of Probability - WBERLANG_B .....	208
2. Erlang's Busy Probability - WBERLANG_C .....	208
3. Inverse Exponential Cumulative Distribution - WBEXPOINV .....	209
4. Inner Sum Product - WBINNERPRODUCT .....	209
5. Logistic, Cumulative Distribution - WBLOGISTIC .....	209
6. Logistic, Probability Density Distribution - WBLOGISTICDENS .....	210
7. Logistic, Inverse Distribution - WBLOGISTICINV .....	210
8. Inverse Multinomial Cumulative Distribution - WBMULTINV .....	210
9. Standard Normal Linear Loss Function - WBNORMSL .....	211
10. Inverse Triangular Cumulative Distribution - WBTRIAINV .....	211
11. Inverse Uniform Cumulative Distribution - WBUNIFINV .....	212
<b>6 OVERVIEW OF MATHEMATICAL MODELING .....</b>	<b>213</b>
Introduction .....	213

---

Linear vs. Nonlinear Expressions and Linearization .....	213
Linear Expressions .....	213
Nonlinear Expressions .....	214
Linearization .....	214
The Solution Process: Determining Optima .....	215
Local Optima vs. Global Optima .....	215
Convexity .....	217
Smooth vs. Non-smooth Expressions .....	218
Solution Outcomes .....	220
Case 1: Optimization Models .....	220
Case 2: Non-optimization Models .....	221
Guidelines for Modeling with What'sBest! .....	222
General Modeling Guidelines .....	222
Nonlinear Modeling Guideline .....	223
Scale the Model to a Reasonable Range of Units .....	223
Simplify Relationships .....	224
Reduce Integer Restrictions .....	224
Guidelines for Stochastic Modeling .....	225
Multistage Decision Making Under Uncertainty .....	225
Recourse Models .....	227
Defining an SP Model in What'sBest! : Simple 2-Stage Example .....	228
Defining an SP Model in What'sBest! : Multi-Stage Example .....	236
Sampling a Scenario Tree .....	243
Guidelines for Chance-Constrained Modeling .....	244
Solving Second Order Cone Programs .....	251
<b>7 SAMPLE MODELS .....</b>	<b>255</b>
Blending .....	258
Application Profile .....	258
Chance-Constrained Blending .....	263
Application Profile .....	263
Box Design .....	267
Flow Network Modeling .....	270
Bond Portfolio Optimization .....	278
Application Profile .....	278
Lockbox Location .....	284
Markowitz Portfolio Problem .....	288
Application Profile .....	288
Portfolio with Transaction Costs .....	292
Application Profile .....	292
Portfolio - Minimizing Downside Risk .....	295
Application Profile .....	295
Portfolio - Scenario Model .....	298
Seasonal Sales Factoring .....	304
Exponential Smoothing .....	308
Application Profile .....	308
Linearization Option: Construction Cost Estimation .....	313
Application Profile .....	313

---



Stratified Sampling.....	317
Application Profile .....	317
Car Pricing .....	320
Media Buying .....	324
Application Profile .....	324
Multi-Period Inventory Management.....	327
Application Profile .....	327
Product Mix.....	330
Application Profile .....	330
The Building Block Method .....	334
Application Profile .....	334
Waste Minimization in Stock Cutting .....	339
Application Profile .....	339
Plant Location .....	344
Staff Scheduling.....	349
Application Profile .....	349
Staff Scheduling: Preferred Assignment .....	353
Application Profile .....	353
Staff Scheduling: Two Stage Fixed Shift .....	360
Application Profile .....	360
Stage 1: Cost Minimization .....	360
Stage 2: Preference Maximization .....	365
Pipeline Optimization.....	369
Application Profile .....	369
Shipping Cost Reduction .....	373
Application Profile .....	373
Traffic Congestion Cost Minimization .....	376
Application Profile .....	376
Truck Loading.....	379
Application Profile .....	379
Crop Allocation Under Uncertainty .....	383
Application Profile .....	383
Put Option.....	390
Application Profile .....	390
<b>8 TROUBLESHOOTING .....</b>	<b>399</b>
FAQ Frequently Asked Questions .....	399
Error Messages & Warnings.....	406
Errors from VBA Code.....	406
Runtime Errors.....	407
Errors from an embedded application.....	408
Invalid Outside Procedure .....	408
ADDINLINK - Multiple Add-in Links .....	408
ARITHERR - Arithmetic Error .....	409
BLKCELL - Blank Cell Warning .....	409
ENTIRERANGE - Entire Range Selection.....	410
EXLVER - Excel® File Format.....	410
FORMULA1 - Formula Parsing .....	411

---

FORMULA2 - Unsupported Functions.....	411
FORMULA3 - External Reference .....	412
FUNCADDIN - Failed to Access the Add-in .....	413
FUNCMACRO - Failed to Access the Macro .....	413
FUNCSERVER - Failed to Access the Server .....	414
HIDSNAME - Hidden Solvers Names.....	415
IKBREP - K-Best WBIKB_REP Format.....	417
INDICMOD - Indicator Model Cell Reference.....	417
INFEASIBLE - No Feasible Solution Found .....	418
INFLARG - Large Infeasibility.....	419
INTERRUPT - Solver Interrupt .....	419
INVMOD - Invalid Model.....	421
IRRECONST - Irreconcilable Constraints.....	421
ITRLIM - Iteration Limit Reached.....	422
LICCAP1 - Constraint Limit .....	422
LICCAP2 - Adjustable Cell Limit.....	423
LICCAP3 - Integer Cell Limit .....	424
LICCAP4 - Nonlinear Adjustable Cell Limit .....	424
LICCAP5 - Global Adjustable Cell Limit .....	425
LICKEY1 - Failed to Process License Key .....	426
LICKEY2 - Pending License Expiration.....	426
LICKEY3 - Expired License Key.....	427
LICKEY4 - Pending Expiration of Option Trial.....	427
LICKEY5 - License Key Dongle Required .....	428
LICOPT1 - Global Solver Not Licensed.....	428
LICOPT2 - Nonlinear Solver Not Licensed.....	429
LICOPT3 - Barrier Solver Not Licensed .....	429
LICOPT4 - Mixed Integer Solver Not Licensed .....	429
LICOPT5 - Stochastic Solver Not Licensed .....	430
LICOPT6 - Conic Solver Not Licensed .....	430
LOOKUP - Unsupported Lookup Usage.....	431
MEMORY - Insufficient Memory .....	431
MODERR - Parsing Cell Formula.....	432
NAME - Unsupported Name.....	433
NLINCELL - Nonlinearities Present .....	433
NOADJ - No Adjustable Cells.....	434
NOBEST - No Best Cell.....	435
NOCONST - No Constraint Cells .....	435
NUMERICAL - Numerical Error .....	436
OMITTED - Omitted Cell Reference.....	436
QUAPREC - Quadratic Recognition.....	437
RUNTIME - Runtime Limit Reached.....	438
SOLVERGOP - Global Solver Use.....	438
SOLVERR - Solver Error .....	439
SPCONFLICT - Stochastic Conflicting Declarations .....	440
SPCORR - Stochastic WBSP_CORR Format.....	441
SPDIST1 - Stochastic WBSP_DIST 1 Format .....	441

---

SPDIST2 - Stochastic WBSP_DIST 2 Format .....	442
SPDIST3 - Stochastic WBSP_DIST 3 Format .....	442
SPERR - Stochastic Error .....	443
SPHIST - Stochastic WBSP_HIST Format .....	444
SPRAND - Stochastic WBSP_RAND Format .....	444
SPREP - Stochastic WBSP_REP Format .....	445
SPSTSC - Stochastic WBSP_STSC Format.....	446
SPVAR - Stochastic WBSP_VAR Format .....	446
STRARG - String Arguments Found .....	447
STRLIST - String List Error.....	447
STRRES - String Result of Formula .....	448
SUMIF - Unsupported Sumif Usage .....	448
TEMPFILE - Error Managing Temp Files .....	449
UNBOUNDED - Unbounded Model.....	449
UNDEFREF - Undefined Reference.....	450
WBCARDFORM - Cardinality Cell Format .....	451
WBDUFORM - Dual Cell Format.....	451
WBLOFORM - Lower Range Cell Format .....	452
WBSEMICFORM - Semi-continuous Cell Format .....	453
WBSOSFORM - Special Ordered Sets Cell Format .....	454
WBUPFORM - Upper Range Cell Format .....	454
<b>APPENDIX A: INSTALLATION DETAILS .....</b>	<b>455</b>
Installation.....	455
What'sBest! Example Files .....	455
Setup Type.....	455
What'sBest! Add-in Files .....	456
Location of the Add-In Files .....	456
Installation Related Problems .....	456
Settings for Microsoft® Excel® 2007, 2010, 2013 .....	456
Settings for Microsoft® Excel® 1997-2003.....	457
Add-ins.....	459
Location of the Add-In Files and Update Links.....	460
Uninstall Files .....	462
<b>APPENDIX B: CONTACTING LINDO SYSTEMS .....</b>	<b>465</b>
www.lindo.com .....	465
<b>INDEX .....</b>	<b>467</b>

---

---

---

# Preface

---

What'sBest!® 13.0 makes available to your Microsoft® Excel® spreadsheet program a highly developed solver capable of performing linear, integer, quadratic, general nonlinear, global, and stochastic optimization on the most difficult of problems. What'sBest!® gives you access to this solver from within Excel®, and may either be run directly or called from within Visual Basic®.

The earliest version of What'sBest!® became available in 1984 for VisiCalc®, and What'sBest!® has been under continuous development since then. Models have been built for What'sBest!® that solve problems in virtually every field of professional endeavor. The Sample Models are provided to demonstrate the range of applications for What'sBest!.

What'sBest!® 13.0 includes major solver enhancements to increase speed and reliability on broad classes of linear, integer, quadratic and general nonlinear models. Other significant enhancements include an improved global solver, an updated pre-solver, and greater user control over the solution process.

## ❑ Positive Semi-Definite POSD-SDP

This feature is an additional benefit to the Conic Solver, for models being convex quadratic.

- The Semi-Definite Program (SDP)/Positive Definite (POSD) feature adds a constraint on a matrix to be positive semi-definite, including integer variables. This can estimate a covariance matrix for a portfolio for instance.
- Specify any symmetric range by using the function WBPOSD() on the adjustable cells; this will define the lower triangular matrix.

## ❑ Nonlinear Solver Programming

- Improved default settings for NLP's gives 5% average speed improvement.
- Faster processing of long nonlinear expressions in NLP's, e.g., 1000's of terms as found in nonlinear regressions with 1000's of observations.

**❑ Global Solver**

- Global solver supports more functions, such as "cdf" and "inverse cdf" of distributions such as Normal, Exponential, Logistic... from the available set of functions.

**❑ Linear Solver Programming**

- The Simplex Linear Programming algorithm implementation has been improved for speed and robustness. The performance improvements compared to previous version is 90% for Primal Simplex and 45% for the Dual Simplex.

**❑ Mixed Integer Solver Programming**

The Mixed Integer Programming solver includes a number of new features:

- Knapsack related cuts improvements; significantly faster solving times on models with certain knapsack-like constraints.
- Improved default node selection rules improves performance on most MIP's.
- New branching variable rule options: maximum coefficients and neighborhood branching, which can reduce number of branches on certain MIP's models.
- Perspective reformulation capability gives improved performance on quadratic portfolio models with semi-continuous variables, for instance min-buy quantities.

**❑ Pre-solver Improvements**

- The preprocessing for Linear/Mixed Integer Programming can significantly reduce the coefficient density of certain dense matrices.

**❑ Stochastic Support improvements**

- Added a function WBSP\_MEAN(), so the user can place the Expected Value for any random cell anywhere else in the spreadsheet. This value for the Objective cell is already given in the Status Report.

**❑ Statistical Functions**

The user can define two additional probability functions:

- WBERLANG\_B(): Erlang's loss probability for a service system with X servers and an arriving load of A, no queue allowed.
  - WBERLANG\_C(): Erlang's busy probability for a service system with X servers and an arriving load of A, with infinite queue allowed.
-

---

**❑ Additional Functionalities**

- Redesign of a splash window informing the user of any remnant of other spreadsheet modeling interface on the same model; so asking to integrate or remove such hidden names.
- Redesign of the Locate feature to look for any Adjustable, Best Constraint, Violated, Dual, WBCALC, WBOMIT names in the workbook.
- Add a feature to generate a K-Best report, via a "WB!\_KBest" tab.
- Correction of compatibilities when the user develops its own macro that calls the *What'sBest!* add-in, and invokes other workbooks.
- Adjust error and warning messages when using solvers and debuggers, clarifying relevance of non-default options.
- Correction to support models being designed on non-English version of Excel®, with mixing languages.
- New set of arguments for the VBA functions `wbIntegerSolverKBestReport`, `wbSetIntegerOptions`, `wbSetNonlinearOptions`, with adjusted error codes.
- Correction in the order of the `WBTRIAINV` function arguments.

## *Other Valuable Features*

**❑ Convert Model Format**

The solver will assist you to convert a model made via competing spreadsheet modeling interfaces to a *What'sBest!* format. It will extract any existing data or information to set the Adjustable, Best cells, and Constraint cells from the default selected spreadsheet tab. Then just click on Solve to see the *What'sBest!* results.

**❑ Support of Excel® .XLSX, .XLSM, .XLSB file formats**

The solver module has been redesigned to support up-to-date platforms and operating systems (Windows® XP, Vista®, and 7, 8 with Microsoft® Excel® 2002 or Excel® 2007, 2010, 2013). *What'sBest!* can run models saved with the new workbook format ".XLSX", ".XLSM", or ".XLSB" with the maximum size of 16384 columns and 1048576 rows. *What'sBest!* is also provided as a 64-bit version for Excel® 2010 or 2013, 64-bit.

**❑ Select Display Language to be English, Chinese, French, or Japanese**

This feature allows the user to select the language of his choice to be either English, Chinese, French, or Japanese without reinstalling the add-in. The language selection makes easier the project for companies working in a multi-cultural environment.

**❑ Simulation Support**

Based on a stochastic model, the user can set up the random parameters and their associated distributions, and *What'sBest!* will calculate the values of the reporting cells. This feature is useful for simulating the behavior of some cells along the scenarios, and to display their histograms, without defining an adjustable, constraint, or objective cells.

**❑ Multithreading Support**

This includes multi-cpu extensions to take advantage of computers with multicore processors. The extensions are of two types: concurrent solvers and parallel solvers. A concurrent solver runs two or more different algorithms simultaneously on the same problem. As soon as one solver finishes, all solvers are stopped. Concurrent solvers tend to give higher utilization of multiple cores but may not give reproducible results, e.g., if there are alternate optima. A parallel solver (repeatedly) splits the task of solving a problem into two or more subtasks and then allocates these subtasks over multiple cores. A parallel solver will generally give reproducible results but may not achieve 100% utilization of all available cores.

The *What'sBest!*® development team wishes you the Best in all your optimization endeavors!

Copyright © 2014, LINDO Systems, Inc.

---



---

---



---

# 1 *Getting Started with What'sBest!*

---

## ***What is What'sBest! ?***

What'sBest! makes available to your Excel® spreadsheet program a highly developed solver capable of performing linear and nonlinear optimization on the most difficult of problems. What'sBest! gives you access to this solver from within Excel®, and may either be run directly or called from within Visual Basic®.

People in business, finance, science, math, and many other fields use What'sBest! every day to model and solve problems in production, financial planning, personnel scheduling, resource allocation, portfolio management, stock cutting, inventory control... It's a long list to which you will want to add your own application. To demonstrate some of the range of applications for What'sBest!, sample models are provided with the software and many are explained in Chapter 8, *Sample models*.

## Optimization Models

Optimization helps you find the answer that yields the most desirable result — the one that attains the highest profit, output, or happiness, or the one that achieves the lowest cost, waste, or discomfort.

Often these problems involve making the most efficient use of your resources — including money, time, machinery, staff, inventory, etc.

Optimization problems are classified as linear or nonlinear depending on whether the relationships in the problem are linear with respect to the variables. What's*Best!* can solve both linear and nonlinear problems, with optional integer restrictions. For more information on optimization and the solution process, please refer to *Overview of Mathematical Modeling*. For additional reference, we recommend the LINGO textbook, *Optimization Modeling with LINGO*, or the LINDO textbook, *Optimization Modeling with LINDO*, both by Linus Schrage and available through LINDO Systems.

## Non-Optimization Models

Non-optimization models do not have a cell defining an objective function that is to be maximized or minimized. A common purpose of such models is to solve an equation. What's*Best!* can find values that satisfy sets of equations or satisfy circular references. Similarly, What's*Best!* can find values to accomplish a desired result — commonly called goal seeking or backsolving. The sample model *Flow Network Modeling* is an example of a non-optimization model.

## Models with Integer Restrictions

Users frequently need to find answers that consist of whole units (i.e., variables expressible as integers). In personnel scheduling, for example, the most efficient use of workers may call for 2.37 persons on a shift, but it's difficult to find .37 of a person who is capable of meaningful work. Therefore, What's*Best!* allows you to restrict values to be whole numbers (or general integers). Binary integer (0/1) restrictions can also be helpful in yes/no or on/off decisions.

---

# System Requirements

To install and run *What'sBest!*, check that you have the following:

## Software

- ◆ Microsoft® Windows® 7, 8 or Windows® XP, Vista®
- ◆ Microsoft® Excel® 32-bit version 2002 or higher, version 2007, 2010, 2013
- ◆ or Microsoft® Excel® 64-bit version 2010, 2013 with latest Service Packs
- ◆ Microsoft® .NET Framework 4.0

## Hardware

- ◆ Pentium-class PC
- ◆ 500 MB of RAM
- ◆ 50 MB of free disk space

An Internet connection is required to download the latest version of *What'sBest!*. You can also contact LINDO Systems to obtain a copy. Add-ins, library and executable files from LINDO Systems are digitally signed. Additional information can be found in the *Installation Overview*.

---

# Installation Overview

To get up and running quickly, first close all programs and simply run *setup.exe* from the Windows desktop or from the CD and follow the prompts in the dialog boxes that follow.

The setup program offers *Default* and *Specified* installation. The *Default* installation option analyzes your system for the critical information required to successfully install What'sBest!. When you select *Default* as the installation type in the initial dialog box, the add-in file is copied into a directory entitled *Library* within the main Excel® directory.

The *Specified* installation option is available for situations that require more information from the user and for users who prefer controlling the details of installation. See the section entitled *Installation* for more information.

*Default* installation is recommended for most environments. However, we recommend you select *Specified* installation under the following situations:

- ◆ You have more than one copy/release of Excel® installed on your system.
- ◆ Excel® is installed on a network server rather than a local drive.
- ◆ Your system runs on a non-English version of Windows.

If you are updating from an earlier release, the location that you specify for the program files may affect how your existing models are interpreted. Carefully read the information displayed during installation, as well as the Location of the *Add-In Files and Update Links* section.

As the last step in installing What'sBest!, Excel® will open and you will find a new toolbar (What'sBest!) and menu (WB!) specific to the What'sBest! program. These are discussed in the *The What'sBest! Environment: Menu and Toolbar* section. If you do not find the *WB!* menu present, please go to *Tools\Add-ins* and check the 'What'sBest!' entry or try reinstalling What'sBest!.

You may be prompted for a license key the first time the software runs. You will find your What'sBest! license key enclosed with your CD. Please enter the license key exactly as it appears, including all hyphens. If you have requested and received a license key via e-mail, you may copy-and-paste it directly into the space provided (*Ctrl-C* to copy, *Ctrl-V* to paste).

If you would like to run a trial version of What'sBest! (150 constraints, 300 variables, and 30 integers), no license key is required, and just click *Trial* here.

If you have misplaced your license key, you will need to contact LINDO Systems.

---

You can now start building and solving models using the *What'sBest!* menu and toolbar, integrated in the Ribbon bar in Excel® version 2010:

The screenshot shows the Microsoft Excel 2010 interface with the 'What'sBest!' ribbon active. The ribbon includes sections for 'Adjustable' (Make Adjustable, Remove Adjustable), 'Best' (Minimize, Maximize), 'Constraints' (Less Than, Greater Than, Equal To), 'Integers' (Integers, Options, Advanced), 'Solve' (Solve, Locate, License, Register, Check Update), and 'Information' (Help, About). The spreadsheet below contains a linear programming model for 'SWINE & ROSES Hog Farm'.

Item	1	2	3	4	Nutrients Supplied	Minimum Req'd	Dual Value
Nutrient A	2.2	3.4	7.2	1.5	0.0	Not >= 2.4	\$1.00
Nutrient B	1.4	1.1	0.0	0.8	0.0	Not >= 0.7	\$1.00
Nutrient C	2.3	5.6	11.1	1.3	0.0	Not >= 5.0	\$1.00
Nutrient D	12.0	11.9	41.8	52.1	0.0	Not >= 21.0	\$1.00
Cost/Bushel	\$35.00	\$50.00	\$80.00	\$95.00			
Percentage of Blend	0.0%	0.0%	0.0%	0.0%	Unity? Not =	Total Cost	\$0.00
Dual Value	\$1.00	\$1.00	\$1.00	\$1.00			

In Excel® version 2002, the menu and toolbar show as follow:

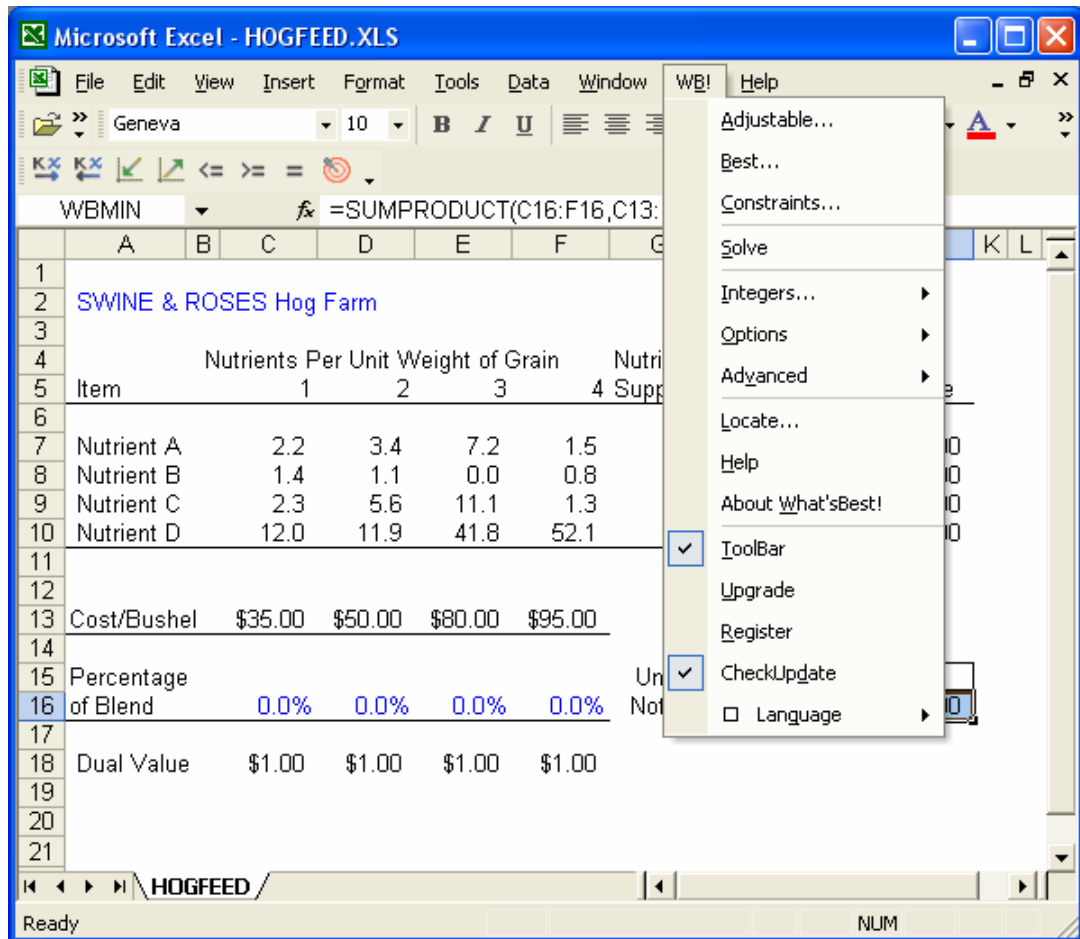



# The What'sBest! Interactive Environment

What'sBest! offers two interactive methods to access commands, the What'sBest! menu and toolbar. This section describes how to effectively use this interface.

In Excel® versions 2007-2013, both the menubar and the toolbar are integrated in the Ribbon layout:

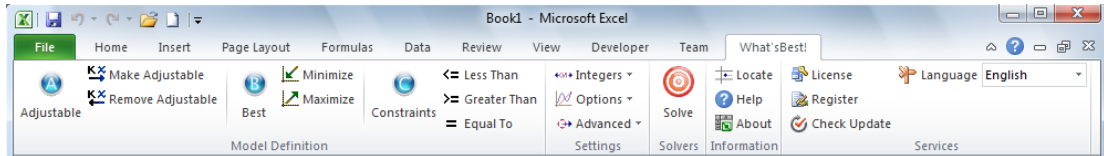

In Excel® version 2002-2003:

- 1) The What'sBest! menu (*WB!*) is embedded in the main Excel® menu bar and appears as follows:

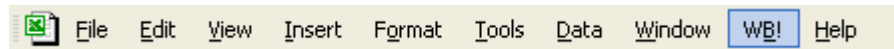

The *WB!* menu contains all the commands discussed in *ABC's: Basic Functions, and Additional Commands*.

- 2) The What'sBest! toolbar can float on your screen or be repositioned to a preferred part of the Excel® window and appears as follows:

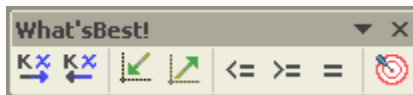

The buttons on the toolbar correspond to the menu commands *Adjustable...*, *Best...*, *Constraints...*, and *Solve*, which are discussed in *ABC's: Basic Functions*.

Of these two access methods, the *What'sBest!* menu provides for full interactive use of the entire range of *What'sBest!* commands. For faster access, the *What'sBest!* toolbar offers rapid one-click access to the most commonly used operations. The *What'sBest!* toolbar also makes tool tips available. To learn the function of a particular toolbar button, just move the cursor over the button for a second and a statement of the button's function will appear as follows:

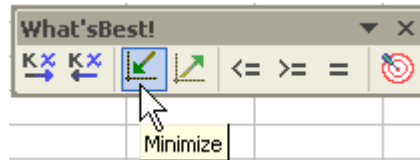

When *What'sBest!* is first installed, the following events should occur:

- 1) the *What'sBest!* add-in is loaded;
- 2) the *What'sBest!* menu is inserted in the Excel® menu bar; and
- 3) the toolbar appears in floating (undocked) mode. The user may then reposition the *What'sBest!* toolbar to a preferred part of the Excel® window.

To remove the toolbar from view, either go to WB!|Toolbar or to View|Toolbars on the main Excel® menu bar and uncheck the *What'sBest!* toolbar. Reverse the process to return the toolbar to view. Should you wish to remove the *What'sBest!* toolbar, you would use View|Toolbars|Customize... command, select the *What'sBest!* toolbar, and press the Delete button. You would then have to reinstall *What'sBest!* in order to restore the toolbar.

*What'sBest!* advises the user as to its progress via the Excel® status bar displayed at the bottom of the Excel® window. This bar normally displays "Ready", but displays other messages when either Excel® or *What'sBest!* is performing some activity that may be prolonged.



For further information on the *What'sBest!* add-in, see the *Add-ins* section.

---

# Developing a Model in What'sBest!

## *The ABC's: Three Steps to What'sBest!*

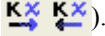
There are three steps to setting up a model to be solved by What'sBest!. Throughout this help file, you'll find them referred to again and again. We call them the ABC's (Adjustable, Best, and Constraints):

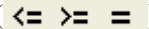
- A. **Identify Adjustable Cells:** The *adjustable cells* are the cells in the worksheet that What'sBest! can adjust in its quest for a solution. In mathematical programming terms, these are called variables. These can be defined using either the menu command (*Adjustable...*) or the toolbar button ().
- B. **Define Best:** The *best cell* is the goal, or objective, of your solution. Typically, this is to maximize or minimize an adjustable cell or some function of the adjustable cells. What'sBest! allows only one best cell in the model. No best cell is needed when equation solving or goal seeking. The menu command (*Best...*) or the toolbar button () can be used to define the best cell.
- C. **Specify Constraints:** The *constraint cells* identify any limitations in a model. For example, "Raw materials used in production must be less-than-or-equal-to raw materials on hand". The constraint cells enforce these restrictions. They are defined by either the menu command (*Constraints...*) or the toolbar buttons ().

Once you've specified the ABC's, you can solve () your worksheet model and find the best answer to your problem.

---

# TUTORIAL

This tutorial will introduce you to *What'sBest!* by showing you how to solve a simple linear problem called the *XYZ Production Problem*. You should open the sample problem file *XYZ.XLS* located in the *WB* directory in your C: drive, so you can finish formulating the model in this tutorial (The other sample models have been completely formulated for you and are ready to solve).

Please note that the following discussion uses Excel® naming conventions (such as \$C\$5:\$D4) throughout.

## The XYZ Production Problem

XYZ Corporation builds two computer models – the *Standard* and the *Deluxe*. The Standard has a profit per unit of \$300, and the Deluxe has a profit per unit of \$500. The two models are produced from three components: the Standard computer tower, the Deluxe computer tower, and a hard drive.

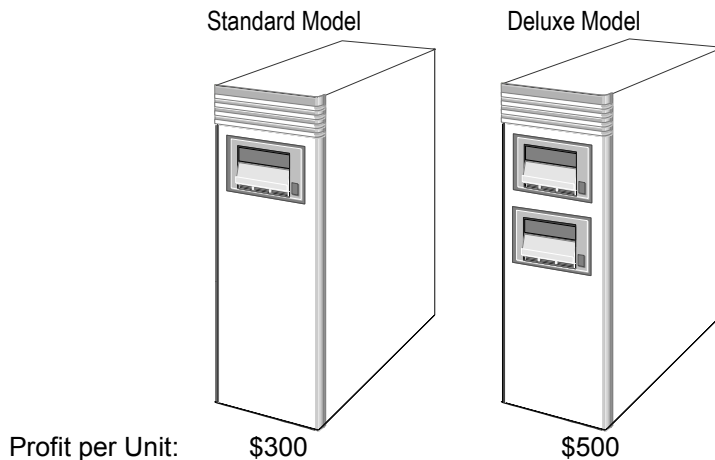

**Problem** What combination of Standard and Deluxe computer towers will maximize XYZ's profit from the components currently in stock?

Unless specified otherwise during installation, the *XYZ.XLS* file was copied to the *WB* subdirectory. If you haven't already done so, open the *XYZ.XLS* sample file:

---

## The XYZ Worksheet Before Optimization

The screenshot shows an Excel spreadsheet with the following data:

XYZ COMPUTER CORPORATION PRODUCTION PLAN				
Product:	Standard	Deluxe		
Quantity to Produce:	0	0	PROFIT:	
				\$0
Profit per Unit:	\$300	\$500		
Product Component Requirements				
Components:	Quantity Required:		Total Usage	Number In Stock
	Standard	Deluxe		
Standard Tower	1	0	0	60
Deluxe Tower	0	1	0	50
Hard Drive	1	2	0	120

Examine the layout and logic of the model. You might want to experiment with various “What If?” projections. For example, try to adjust the *Quantity to Produce* in both cells (C5 and D5), so as to maximize profit (G6) without allowing your *Total Usage* (E15:E17) to exceed the number of components in stock (G15:G17).



For example, a sensible production plan might be to make as many *Deluxe* models as possible (since these yield the highest per unit profit). Then, with what is left, make as many *Standard* models as possible. This production plan would use all 50 *Deluxe* computer towers (E16), 20 *Standard* computer towers (E15), and all 120 hard drives (E17) currently in stock. It would result in a total profit of \$31,000 (G6). However, this solution can be improved by using *What’sBest!*.

## The ABC's

Now, let's apply the ABC's to this spreadsheet to show how *What'sBest!* provides you with the best possible answer.

### A. Determine Adjustable Cells

In this example, we first want *What'sBest!* to adjust the value for *Quantities to Produce* for both models of computer (in cells C5:D5). *What'sBest!* requires that numbers be placed in all adjustable cells. You may simply enter zeroes in these cells, although any number will suffice. Next, specify that cells C5 and D5 are adjustable by selecting both cells and either:

- 1) choose *Adjustable...* from the *WB!* menu, and click *OK*, or
- 2) use the *Make Adjustable*  toolbar button, or  to *Remove Adjustable*.

If you use the *WB!* menu to access the *Adjustable* dialog box, you'll notice that the *Adjustable* dialog box has \$C\$5:\$D\$5, the current selection, entered in the *Refers To:* text box. In the drop-down box, the default setting *Make Adjustable* is already selected, so you need only click *OK*. *What'sBest!* identifies an adjustable cell by applying an *Adjustable* style, distinguished by a default font color of blue (as a visual reminder) and unlocked cell status as follows:

**The Adjustable Cells in XYZ**

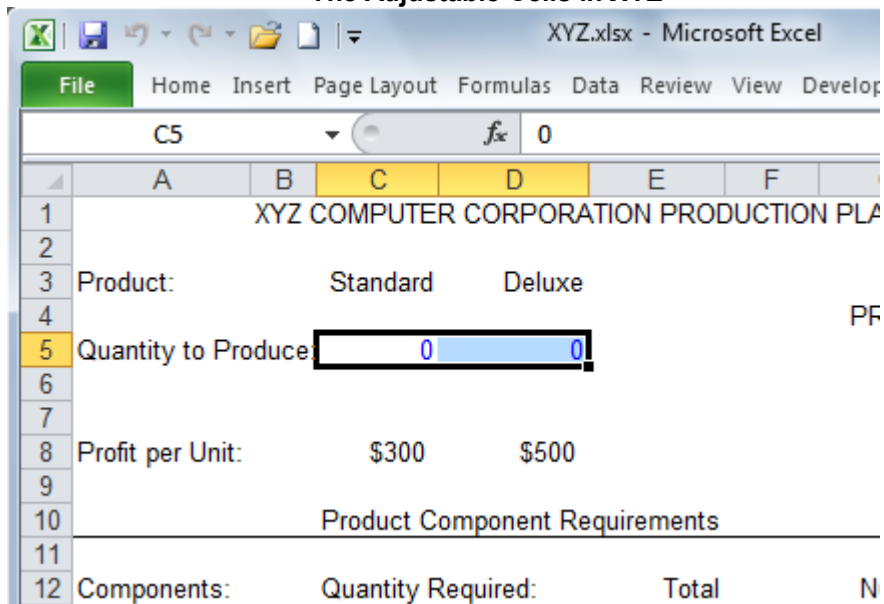

	A	B	C	D	E	F
1	XYZ COMPUTER CORPORATION PRODUCTION PLAN					
2						
3	Product:		Standard	Deluxe		
4						PF
5	Quantity to Produce:		0	0		
6						
7						
8	Profit per Unit:		\$300	\$500		
9						
10	Product Component Requirements					
11	-----					
12	Components:		Quantity Required:		Total	N

**B. Define Best**

XYZ Corporation's goal is to maximize profit, which may be expressed as:

$$\begin{aligned} \text{Total Profit} = & (\text{Quantity of Standard Models Produced}) \\ & \text{TIMES } (\text{Profit per Unit of Standard Models}) \\ & \text{PLUS } (\text{Quantity of Deluxe Models Produced}) \\ & \text{TIMES } (\text{Profit per Unit of Deluxe Models}) \end{aligned}$$

## 14 CHAPTER 1

This formula appears in cell G6 as  $=C5*C8+D5*D8$ . This is the sumproduct of C5:D5 and C8:D8, and could also be entered as  $=SUMPRODUCT(C5:D5,C8:D8)$ . This function can be especially useful when doing similar operations on larger ranges.

To make G6 the objective (best cell), move the cursor to that cell and either:

- 1) choose *Best...* from the *WB!* menu, select *Maximize*, and click *OK*, or
- 2) use the *Maximize* toolbar button .

If you use the *Best* dialog box via the menu, you'll notice that the right text box on the *Best* dialog box indicates \$G\$6, the current selection.

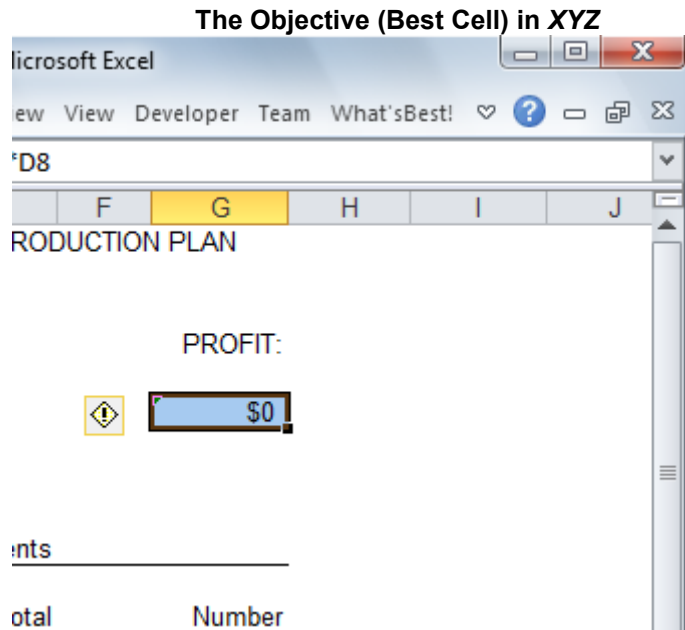





### C. Specify Constraints

The constraints for this problem are that the *Total Usage* of components (E15:E17) must be less-than-or-equal-to the number in stock (G15:G17).

The formula for *Total Usage* of *Standard* tower components is  $=C5*C15+D5*D15$ . Cells E16 and E17 have similar formulas for the *Deluxe* tower and hard drives.

To specify the constraints, highlight the range F15:F17, then choose *Constraints...* from the *WB!* menu, and click *OK*. Note that the *Constraints* dialog box has E15:E17 entered as *Left-hand side (LHS)*, =G15:G17 entered as *Right-Hand Side (RHS)*, \$F\$15:\$F\$17 entered in *Store in:*, and  $\leq$  (less-than-or-equal-to), being the default, is entered as the constraint type. Alternately, you may use the  toolbar button after selecting the range to store the constraints. See *The ABC's* for more information on these defaults.

#### Automatic Generation of a Constraint

Product Component Requirements						
Components:	Quantity Required:		Total Usage			Number In Stock
	Standard	Deluxe				
15 Standard Tower	1	0	 0	$\leq$		60
16 Deluxe Tower	0	1	0	$\leq$		50
17 Hard Drive	1	2	0	$\leq$		120

The screenshot shows a spreadsheet window with the following status bar information: Ready, Count: 3, 100% zoom.

At this point, let's briefly summarize what we have done so far:

### The XYZ Worksheet *Before* Optimization

The screenshot shows the following data in the spreadsheet:

XYZ COMPUTER CORPORATION PRODUCTION PLAN					
Product:	Standard	Deluxe			
Quantity to Produce:	0	0			PROFIT: \$0
Profit per Unit:	\$300	\$500			
Product Component Requirements					
Components:	Quantity Required:		Total Usage		Number In Stock
	Standard	Deluxe			
Standard Tower	1	0	0	<=	60
Deluxe Tower	0	1	0	<=	50
Hard Drive	1	2	0	<=	120

- A. Set *Adjustable cells*:** This lets *What'sBest!* know that the spreadsheet cells denoting *Quantity to Produce* (C5:D5) are the variables and can therefore be adjusted as *What'sBest!* seeks an optimal answer.
- B. Define *Best*:** As XYZ's goal is to maximize profit, the total profit (G6) was specified as the objective of optimization. This calls for maximizing the value of the formula in cell G6 through manipulation of the values in the adjustable cells (C5:D5).
- C. Specify *Constraints*:** XYZ's limitations are simply that *Total Usage* of inventory parts (E15:E17) be less-than-or-equal-to the total *Number in Stock* (G15:G17). These constraints are specified by means of the formulas in F15:F17.

Now, you are ready to solve the XYZ model with What'sBest!. When you choose *Solve* from the *WB!* menu or press  on the toolbar, the What'sBest! solver is started and the solver status window appears like the one shown below:

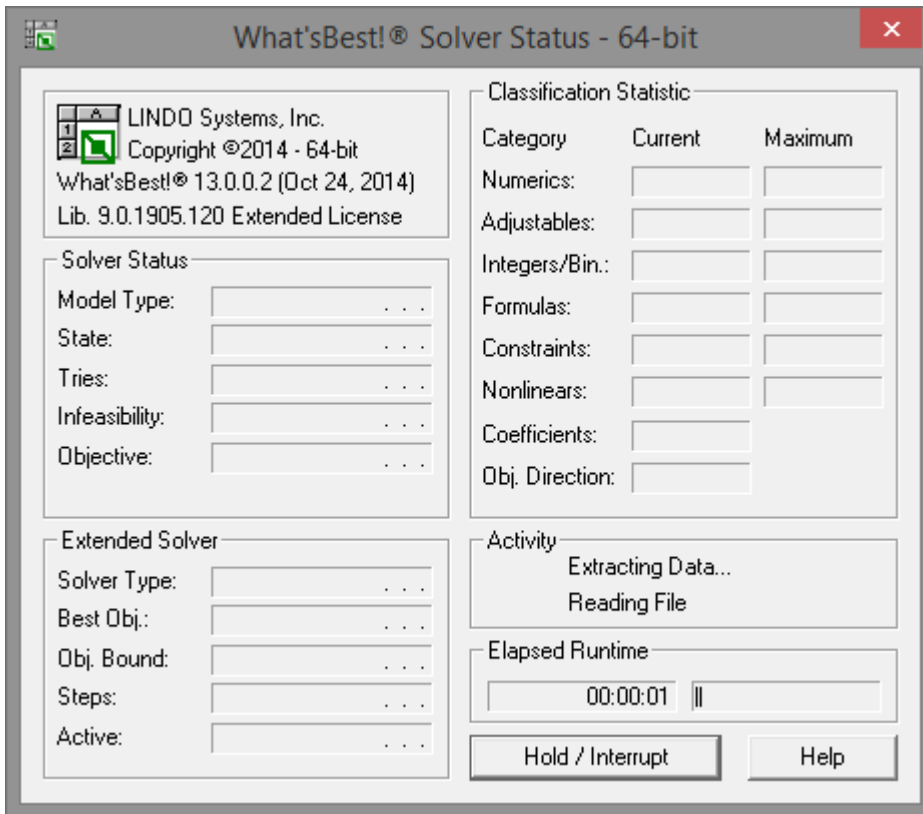

The solver status window contains useful information about the properties of your model and the progress of What'sBest! toward a solution. The information about model properties will also appear on the *WB! Status* worksheet tab added to your workbook after the model is solved, so don't worry if the window doesn't remain long enough for you to read the information it contains. See the *Solve* section for detailed information about the solver status window.

The worksheet soon reappears indicating the highest possible profit:

### The XYZ Worksheet After Optimization

Product Component Requirements					
Components:	Quantity Required:	Total Usage		Number In Stock	
	Standard	Deluxe			
Standard Tower	1	0	60	<=	60
Deluxe Tower	0	1	30	<=	50
Hard Drive	1	2	120	<=	120

The *What'sBest!* solution yields the best possible profit attainable given your resources and constraints. It also tells you the appropriate quantities to produce and the total usage of each component. Note that profit is now \$33,000—considerably higher than the \$31,000 attained by simply building as many Deluxe models as possible.

## What's Best If

It's often useful to explore your optimization model from various angles. For example, what if you learn that the 20 Deluxe computer towers remaining from the *What'sBest!* answer found above (G16 - E16) will be obsolete after the current production run? In that case, it might be better to maximize the utilization of this inventory than to maximize profit. Try this by making *Total Usage* of Deluxe computer towers (cell E16) your best cell to be maximized. This is done by selecting cell E16, choosing *Best...* from the *WB!* menu, clicking *OK* and then re-solving.

---

What'sBest! will maximize the value of cell E16 without regard to the former objective of maximizing *Total Profit*. Note that the resulting production of 50 Deluxe units completely exhausts the obsolete inventory, but that profit has dropped from \$33,000 to \$25,000.

Now, suppose for financial reasons profit must be at least \$32,000. This constraint can be manually entered by simply typing =WB(G6,">=",32000) in a convenient cell (in this case, let's use H6).

Optimizing again with the new constraint in place results in the production of 40 units of each model, a profit of \$32,000, and a surplus of 10 Deluxe towers.

## *Working While Solving*

This simple model solves very quickly. While larger models are solving, you may want to do other work as you wait for your solution.

If you want to work in Excel® while your model is being solved, then just minimize the model being solved and open another copy of Excel® (or whatever application you wish to use). Simply leave the minimized Excel® icon on the taskbar at the bottom of the screen, and your model will continue to solve in the background.

## *The Next Step*

The *ABC's: Basic Functions* and *Advanced Functions* sections explain the What'sBest! commands in depth. To learn more about the principles of optimization modeling, see *Overview of Mathematical Modeling*. If you'd like to move on to more sophisticated problems, see *Sample Models*.

---



---

# 2 ABC's: The Basics of What'sBest!

---

This chapter describes how to use the three basic commands that are used in building almost every model for *What'sBest!*. We'll refer to them as the ABC's – Adjustable, Best, Constraints. These three commands are the first commands at the top of the main *WB!* menu item on the Excel® menu. In addition to the menu commands, you may use the corresponding toolbar buttons on the *What'sBest!* toolbar.

The sections below include in depth discussion of the use of these commands:

Adjustable... 

Best... 

Constraints... 

After you have created your model by setting up the ABC's, you can *Solve*  your worksheet model and find the best answer to your problem.

## Adjustable...

The dialog box posted by the *Adjustable* command appears as follows:

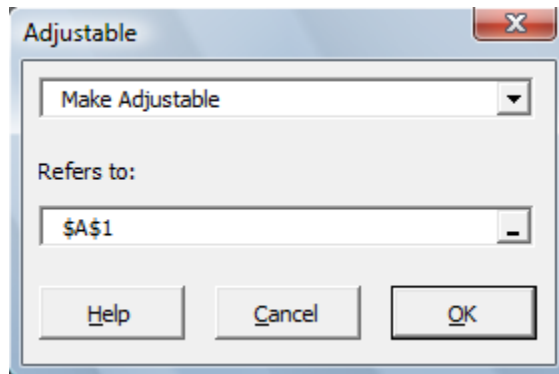

This command allows you to set properties of selected cells in your workbook. Specifically, it is used to identify to *What'sBest!* the cells that may be adjusted by the solver in its search for a solution that optimizes the objective cell while satisfying all constraints.

Enter the range of cells whose properties you wish to set in the *Refers To:* field (the current selection of cells is already entered). Next, select the property you wish to apply to the cells from the drop-down list at the top of the dialog box. You have the following options:

- 1) *Make Adjustable*
- 2) *Remove Adjustable*
- 3) *Make Adjustable & Free or Remove Free*

See below for more detail on these options. Clicking *OK* will apply the change in properties.

### *Make Adjustable*



Select *Make Adjustable* to specify the range indicated in the *Refers To:* text box as adjustable cells.

Before *What'sBest!* can solve a problem, it must know what cells it can change in its search for the optimal solution. These are the adjustable cells. By default, *What'sBest!* assumes the adjustable cells can be set to any non-negative value.

Adjustable cells, also called decision variables, usually represent quantities or activities over which you have direct control. Traditionally, mathematicians refer to them as variables. Some examples might be:

- ◆ the number of televisions to produce
- ◆ the amount of money to be spent on advertising
- ◆ the number of shares to purchase of a particular stock



- ◆ the location of your next service facility

Inappropriate adjustable cells would be things you have no control over, such as:

- ◆ the total demand for televisions
- ◆ the price of advertising to be purchased
- ◆ the risk of a particular stock
- ◆ the local building restrictions

Cells containing equations are also inappropriate as adjustable cells. What'sBest! cannot rewrite an equation (although the value returned by an equation will change, if the equation depends upon any adjustable cells).

What'sBest! will not alter the contents of cells specified as adjustable that contain equations, text, or blanks. In other words, *the cells must be numeric*. Therefore, be sure to enter a numeric value in each of your adjustable cells.

**Note:** When the adjustable quality is applied to a cell, What'sBest! assigns a predefined *Adjustable* style to the cell. This style is automatically made available to each of your What'sBest! models and can be customized (e.g., font color) as you wish.

## Remove Adjustable



Select *Remove Adjustable* to return an adjustable cell to its fixed (non-adjustable) state. By default, a cell is fixed until it has been specified as adjustable. When you instruct What'sBest! to remove a cell's adjustable status, the *Adjustable* style is removed from the cell and you will see the font color revert from blue (or the font color you defined for the *Adjustable* style) to the original color.

After solving a model, you may wish use *Remove Adjustable* to fix some of the adjustable cells at their new values, turning them into constants, and solve again for the remaining adjustable cells.

## Make Adjustable & Free or Remove Free

Select this to take the referenced cells and either set them as adjustable and free (capable of assuming negative as well as positive values) or remove their free status. Making this selection and clicking *OK* will post the *Free* dialog box to facilitate setting or removing the free status. For further discussion, see the section entitled *Free*.

## Refers To

Specify the range of cells that are to be made adjustable or fixed in this text box by using the button on the right edge to bring up a cursor for cell selection. Alternately, you can accept the currently selected cells, which What'sBest! has automatically placed in this box. You can also type the correct cell range directly into the text box.

**Note:** Adjustable cells should not be locked or hidden on a protected sheet.

## Free

The dialog box posted by selecting the *Make Adjustable & Free or Remove Free* command in the drop-down list in the Adjustable dialog box appears as follows:

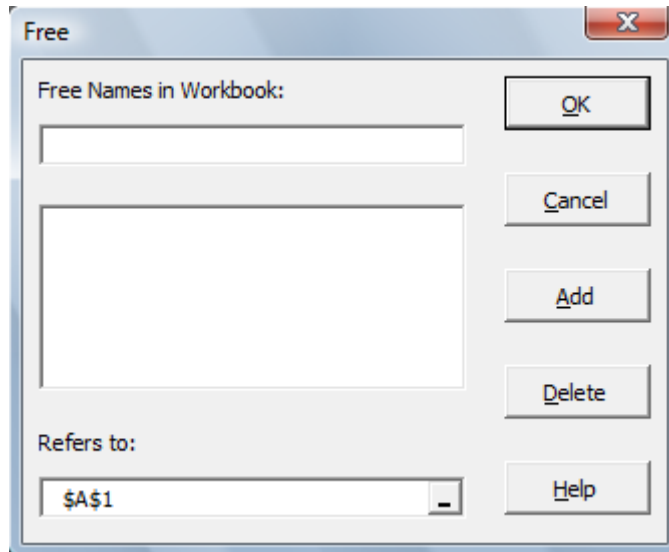

By default, adjustable cells are restricted to being greater-than-or-equal-to zero. However, you may override this default lower bound of zero on an adjustable cell by making it free. Adjustable cells that may assume negative as well as positive values are referred to as free variables. To create an adjustable and free cell(s), specify the cell or cell range you wish to change in the *Refers to:* field. Then, enter a name in the *FREE Names in Workbook:* field. You can choose any combination of letters for your range name. Once this is done, pressing the *Add* button causes *What'sBest!* to assign a *WBFREE* range name to the selected cells, which will appear in the list on the Free dialog box. For instance, if you used the name "BuySell" in the *FREE Names in Workbook:* text box, a range name *WBFREEBuySell* would be assigned to the selected cells.

If the cells are already adjustable, you can make them adjustable and free by following the steps above. Alternately, if you are removing a free variable designation for a given cell range, simply select the name of the range to remove, and press the *Delete* button.

A negative adjustable cell representing the number of televisions to produce would not be meaningful. However, there are scenarios in which allowing an adjustable cell to assume negative values would be appropriate. For example, if you have the ability to either buy or sell a stock, you could create a single adjustable cell representing your decision to buy/sell shares. A positive value would represent the amount to buy and a negative value the amount to sell.

For more information, see the *Adjustable* command above.

## Best...

The dialog box posted by the *Best...* command appears as follows:

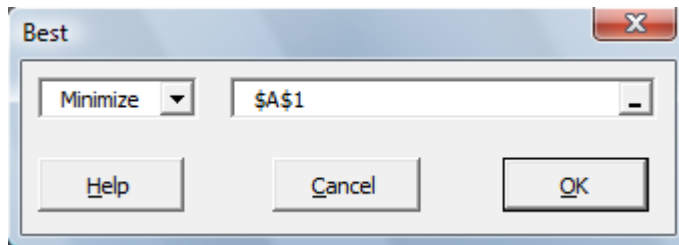

This command is used to specify the cell in your model to maximize or minimize.

Select the objective sense you wish to apply from the drop-down box on the left of the dialog box. Possible options are:



- 1) *Minimize*
- 2) *Maximize*
- 3) *None*

Then, enter the cell you wish to set in the text box on the right of the dialog box. What's *Best!* defaults to entering the current selection. Clicking *OK* will define the best cell.

## Objective:

Minimize or Maximize



Select *Minimize* or *Maximize* to specify whether your objective is to determine the smallest or largest value for the best cell, respectively. These choices may also be made using the *Minimize*  and *Maximize*  toolbar buttons.

For optimization models, you must define a best cell (equation-solving and goal-seeking models do not require a best cell, as discussed below). The best cell, sometimes called the objective of optimization, is the cell whose value is to be minimized or maximized during optimization. The best cell must be an adjustable cell or a formula depending upon an adjustable cell defining exactly what it is you want to optimize.

The two most common objectives of optimization models are to minimize cost or maximize profit, but you can choose to maximize or minimize any adjustable cell or any equation that depends upon one or more adjustable cells. Other frequent targets for minimization are waste, conflict, time required, surplus, and risk. A maximization cell could be something tangible, an equation representing total output, or something less concrete, such as a calculation to estimate employee job satisfaction or the effectiveness of customer service.

You may specify no more than one cell to be maximized or minimized. Whenever you designate a best cell, any previously specified best cell returns to being a non-optimized cell.

In a scenario with multiple goals, you should consider maximizing or minimizing one goal and constraining the others or combining goals into a single equation to be maximized or minimized.

For example, if the goals for your factory are to maximize production output and minimize costs, there are clearly trade-offs between the two goals. You can choose to:

- 1) Maximize output while constraining costs to be less than a desired level.
- 2) Minimize costs while constraining output to be greater than a desired level.
- 3) Combine both goals into a single equation of output minus total cost and maximize the single equation.

### None

Select *None* to void any previously specified best cell. If no best cell is specified in a model, *What'sBest!* will try to find a solution that satisfies all constraints and relationships in the model without trying to maximize or minimize any particular cell. This is referred to as goal-seeking or backsolving.

If you solve a model in which no best cell has been specified, a “No Best Cell Specified” warning appears in the status report after the solution process has completed. This warning is intended to notify the user that the specification of a best cell may have been inadvertently omitted. You may turn this warning on or off by the *No Best Cell* checkbox in the *General Options* dialog box posted by *Options...|General* command.

## Cell range

Specify the cell to be maximized or minimized in this text box by using the button on the right edge to bring up a cursor for cell selection. Alternately, you may accept the currently selected cell, which is automatically selected by *What'sBest!*. You may also type the cell range to be specified as the best cell directly into the text box.

---

# Constraints...

The dialog box posted by the *Constraints* command appears as follows  :

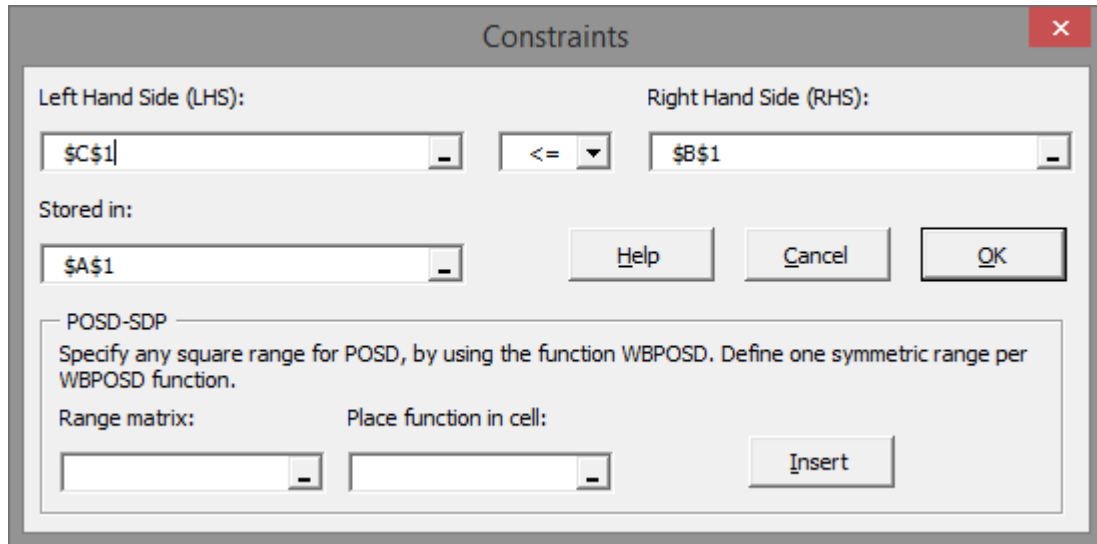

This command is used to specify the resource constraints in your model.

To define a constraint, you must supply the left-hand side of the constraint, the right-hand side of the constraint, and the host cell where the constraint should appear. These go in the *Left Hand Side (LHS)*:, *Right Hand Side (RHS)*:, and *Stored in*: fields, respectively.

Then, select  $\leq$  (less-than-or-equal-to),  $\geq$  (greater-than-or-equal-to),  $=$  (equal-to),  $\leq c$  (convex),  $\geq c$  (concave),  $=c$  (convex), in order to specify the direction of the constraint. If no type is selected, *What'sBest!* will default to  $\leq$  (less-than-or-equal-to). Selecting *None* will clear the cell. Clicking *OK* will apply the constraints. The user can explicitly specify the constraint convexity to the Solver, by integrating a "c" in the direction; see the *Usage Guidelines for Constraints* part for additional information. You need be concerned with  $\leq c$  or  $\geq c$  only if using the Global solver.

**Note:** *What'sBest!* uses the loose inequality operators rather than the strict inequality operators of  $>$  (greater-than) and  $<$  (less-than).

## *Left Hand Side (LHS)*:, *Right Hand Side (RHS)*:, and *Stored in*:

Specify the cells or ranges to be constrained in these text boxes. *What'sBest!* attempts to automatically fill in these boxes based upon what the current selection is. The cells just to the left of the currently selected cells are entered as the Left-Hand Side of the constraint. The cells just to the right of the currently selected cells are entered as the Right-Hand Side of the constraint. The currently selected cells become the *Stored in*: range displayed. When a row is selected, it is assumed the cells just above the row are the left-hand side and the cells just below are the right-hand side of the equation.

If these are not the ranges of cells you want, you can specify the cells or ranges by using the button on the right edge of each text box to bring up a cursor for cell selection or type the ranges in. However, you should use the following table when selecting cells or ranges:

If the Left-hand side includes a...	then Stored In should have a...	and the Right-hand side should have a...
single cell	single cell	single cell
*range	same shape and size range	single cell
*single cell	range	same shape and size range
range	same shape and size range	same shape and size range
*You can relate a left-hand side range to a single right-hand side cell or a right-hand side range to a single left-hand side cell.		

What'sBest! inserts a worksheet function called *WB* in the host cell(s) specified in the *Stored In*: text box (also known as the constraint cells). By clicking on one of the constraint cells and looking at the Excel® formula box, you can see the *WB* function that was created. For example, select the B1 cell, choose the *WB|Constraints...* command, and press *OK* on the *Constraints* dialog box to insert the formula =*WB*(A1, "<=", C1) into the cell B1. This formula indicates that the value in A1 should be less-than-or-equal-to that in C1. This could also be accomplished by selecting cell B1 and pressing the  toolbar button or typing the =*WB*(A1, "<=", C1) formula directly into the cell.

Although it is typically easier to use the What'sBest! commands, constraints can be created in a What'sBest! model by copying or modifying existing constraints. What'sBest! will treat copied constraint cells the same as any constraint cell created by the menu or toolbar *Constraints* command.

---

**Note:** It is not recommended to lock or hide constraint cells on a protected sheet.

---

## POSD-SDP Constraint Range

To allow the use of the Semi-Definite Positive (SDP) capability with the LINDO Solver, specify the selection of the range matrix to be constrained by a Positive Semi-Definite function (POSD), as =*WB*POSD(range). The range defining the matrix should be symmetric with the adjustable cells typically set to be free type (although not required), and greater than one cell.

A sample case is provided with the file "WBPOSDcase.XLSX". This case is based on a covariance matrix, and shows the lower triangular matrix, its constraints, and the non-default option keeping the quadratic recognition on to minimize the sum of squared differences. Also, the POSD feature is not compatible with nonlinear constraints and objective. To retrieve compatibility, the model needs to be convex quadratic, with the adjustable cells set to be free type in the matrix, and the Quadratic Recognition should be turned on.

---

# Usage Guidelines for Constraints

In the real world, decisions are always constrained in some fashion. In the steel business, for example, you work within a budget to acquire finite amounts of ore, coke, alloy metals and power. Orders must be delivered on time and up to specifications, or you risk losing business. Such limits to doing business are referred to as constraints in the language of optimization modeling. With *What'sBest!*, you can use the operators  $\geq$  (greater-than-or-equal-to),  $\leq$  (less-than-or-equal-to), or  $=$  (equal-to) to express your particular constraints.

*What'sBest!* allows you to enter constraints using the four following methods:

- 1) The *Constraints* dialog box.
- 2) The three constraint toolbar buttons.
- 3) Manually entering constraint functions as cell formulas.
- 4) Using VBA to automatically enter constraint functions as cell formulas.

The first two methods only allow the entry of cell references (The dialog box method offers an error-checking interface for out-of-range and other errors). The last two methods allow you the flexibility of entering complex expressions as well as cell references. To learn how to use VBA to enter constraints, see the section titled *wbConstraint*.

Let's consider the following constraints: a resource limitation constraint, "Advertising expenditures must be no more than ( $\leq$ ) \$10,000", and a performance requirement constraint, "Advertising exposures must be at least ( $\geq$ ) 100".

	A	B	C	D	E	F
1	Advertising Projection					
2		EXPENDITURE		BUDGET		
3		\$ -	<=	\$10,000.00		
4						
5		EXPOSURES		REQUIREMENT		
6		0	<=	100		
7						
8						

In your *What'sBest!* model, if an adjustable cell representing the advertising expenditure was in cell B3 and D3 was a fixed cell with a value of 10,000, you could enter the constraint formula `=WB(B3,"<=",D3)` anywhere in the spreadsheet to enforce the first constraint. We've entered it in cell C3, where it makes visual sense. Likewise, in cell C6, the formula `=WB(B6,">=",D6)` enforces the second constraint.

*What'sBest!* would then optimize so as to satisfy these constraints. With B3 selected as the objective to minimize, the program will select at least 100 exposures that add up to the lowest possible expenditure. With B6 selected as the objective to maximize, the program will select the highest number of exposures over 100 whose summed cost is less than \$10,000.

Alternatively, you could do away with cell D3 and use the formula `=WB(B3,"<=",10000)`. The *Constraints* command lets you enter single-cell references in the left-hand side and single-cell references, single-cell range names, or values in the right-hand side of your formula. When entering a constraint formula manually, you have the additional option of entering an expression (which evaluates to a number, not an array) on either side of the Indicator, such as `=WB(B3-B11,"<=",D3+D11)`.

### Constraint Display

Using the *Constraint* option in the *Display* box under the *Options...|General* command, you can set the method of constraint display to either *Indicator* or *Slack*. If you set constraint display Indicator mode (the default), then the constraint is shown in the cell by one of the following eight visual indicators: `<=`, `>=`, `=<=`, `=>=`, **Not <=**, **Not >=**, **Not =**, or `=`. If you set *What'sBest!* to display the constraint in *Slack* mode, then a numeric value known as the *slack* is returned. The slack is the amount by which a constraint is not violated.

For example, *What'sBest!* would display constraint values based upon the following table:

<b>Constraint</b>	<b>Slack Mode</b>	<b>Indicator Mode</b>
<i>Tightly satisfied</i>	0	<code>=&lt;=</code>
<i>Satisfied</i>	<i>positive number</i>	<code>&lt;=</code>
<i>Not satisfied</i>	<i>negative number</i>	<b>Not &lt;=</b>



---

## Constraint-related Problems

Constraints must be properly formulated or they can be a source of problems. Some of the problems are discussed below.

### Too Few Constraints - Unbounded Solutions

Let's return for a moment to the XYZ Production model presented in the *Tutorial of Getting Started*. Had you forgotten to include constraints in the model and tried to solve, *What'sBest!* would have given an error message indicating Solution Status: UNBOUNDED in the WB! Status worksheet. An unbounded solution error occurs when a model is not properly constrained. Profit could be increased without limit by producing an infinite number of computers! *What'sBest!* knows you've left out one or more constraints and indicates that the problem is unbounded.

In an actual production situation, there may be constraints other than raw material or component availability, such as limited plant capacity or labor supply. Excluding any of these could lead to an unbounded solution. Also, *What'sBest!* might give you an unbounded error message if you maximize the wrong cell, or maximize the objective cell when in fact you really wanted to minimize it.

Anytime *What'sBest!* finds the objective heading toward infinity, you'll receive the Solution Status: UNBOUNDED error message. For details, see the topic *UNBOUNDED* in Troubleshooting.

### No Feasible Solution Found - Linear

What if you add a constraint that contradicts one or more of the existing constraints? In the XYZ problem, if you add a requirement that the number of Deluxe computers to be produced is greater than 60, *What'sBest!* will return the Solution Status: INFEASIBLE message in the "WB! Status" worksheet. The original constraint requires that no more than 50 Deluxe computer towers be used. However, this new constraint requires production of at least 60 Deluxe computers, exceeding the limitation of the first constraint.

Anytime *What'sBest!* can't find a solution to a linear problem that satisfies all constraints, you'll see the *INFEASIBLE* error message. By examining the state of the constraints in the returned infeasible solution, you may be able to determine how to reformulate and eliminate the source of infeasibility.

### No Feasible Solution Found - Nonlinear

In a nonlinear problem, the *Solution Status: INFEASIBLE* message may not mean that there is no solution that satisfies all constraints. It only indicates that none can be found from the starting values you've entered in the adjustable cells. If you know or suspect there is a feasible answer to the problem, enter adjustable cell values that yield a feasible or near-feasible solution and try solving from that starting point. Alternatively, using the Global Solver option may help.

One other possible course to follow is to view the constraints in slack mode rather than Indicator mode. This helps you determine which constraints are furthest from being satisfied. Then, enter "educated guesses" for the adjustable cells, values that cause the constraints to come closer to being satisfied, and try solving again from these starting values.

---

## Explicitly Specifying Convexity to the Solver

One of the important considerations for the solver in finding a global optimum is the exploitation of convexity. In layman's terms, if an optimization problem is convex, then a carefully implemented "hill climbing" search algorithm (or valley finding for a minimization problem) will find a global optimum. More generally, if the feasible region is convex, then any strict local optimum can justifiably be declared a global optimum. Our solver is fairly sophisticated in its ability to identify convex expressions. Nevertheless, there may be some constraints that you know have convex feasible regions but you suspect might not be identified as convex by our solver. What's *Best!* allows special constraint types, " $<c=$ ", " $>c=$ ", and " $=c$ " to allow users to identify constraints that have convex feasible regions. For example, suppose we have the constraints:

$$x^3 - 2*x*y + y^3 \leq 6;$$

$$x \geq .5;$$

$$y \geq .5;$$

The feasible region of this set of constraints happens to be convex. The user is justified in writing:

$$x^3 - 2*x*y + y^3 \leq c = 6;$$

More generally, if  $f(x)$  is any function on the left hand side and the user writes:

$$f(x) \leq c = b;$$

The solver will assume that the feasible set for this constraint is convex. This is true for example if  $f(x)$  is a convex or quasi-convex function. Loosely speaking, a quasi-convex function is uni-modal; if you pour water into it, only one puddle would form. A convex function is also quasi-convex.

If you have the constraint  $f(x) \geq b$ , and you know that  $f(x)$  is a concave function then you are allowed to write:

$$f(x) \geq c = b;$$

Finally, if you have the constraint  $f(x) = b$ , and you know that  $f(x)$  is a quasi-convex function then you are allowed to write:

$$f(x) = c = b;$$

The interpretation is that we require  $f(x) = b$ , however, the feasible region to the relaxation,  $f(x) \leq b$ , is convex.

Similarly, if you have the constraint  $f(x) = b$ , and you know that  $f(x)$  is a quasi-concave function then you are allowed to write:

$$-f(x) = c = -b;$$

The interpretation is that we require  $f(x) = b$ , however, the feasible region to the relaxation,  $-f(x) \leq -b$ , or,  $f(x) \geq b$ , is convex.

# Solve...



Once the ABC's (Adjustable, Best, and Constraint cells) have been specified, you are ready to solve your model. Choosing the *Solve* command prompts the *What'sBest!* solver to begin examining and solving your model. During the time that the solver is computing, it displays the *Solver Status* window, which appears as shown below.

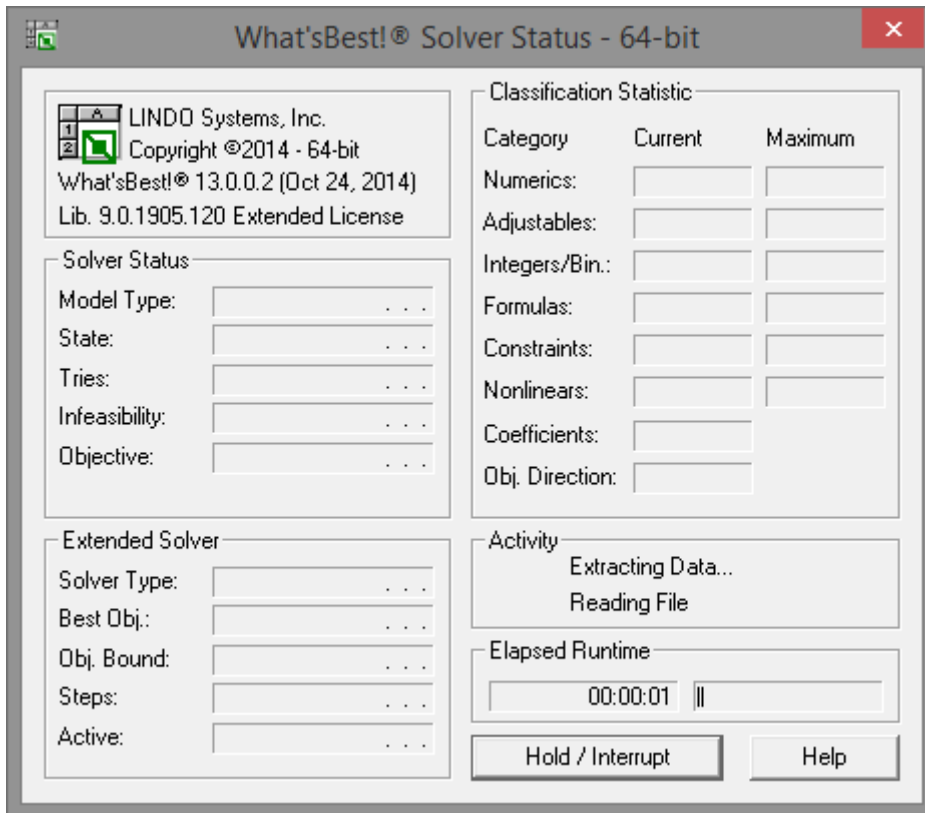

The solver status window remains present for the duration of the solution process, and is updated periodically. Once the solver completes its run, it returns to the workbook to install a new solution and inserts a new worksheet entitled *WB! Status*. This new worksheet is referred to as the status report.

The status report is an easily understood analysis of the model and solution. It provides a hard copy of the information appearing in the solver status window. The section entitled *Getting the Best Results* discusses the information contained in the status report in further detail.

You may use the *InterruptSolver* button on the solver status window to interrupt the solver while it is solving. If you do, you can not expect any useful information to be returned unless you have an integer problem. In the case of an integer problem, the best solution to the point of interruption is returned. For linear problems and non-linear problems, the returned values will not be useful.

The definitions of the information in the *What'sBest!* solver status box are shown below.

**Model Type:** This shows one of six categories your model falls into: *Integer/Quadratic*, *Integer/Nonlinear*, *Integer/Linear*, *Quadratic*, *Nonlinear*, *Linear*. For further information on these categories see the section entitled *Linear vs. Nonlinear Expressions and Linearization* in *Overview of Mathematical Modeling*.

**State:** This shows the state of the current solution. Possible states include *Globally Optimal*, *Infeasible*, *Unbounded*, *Feasible*, *Infeasible or Unbounded*, *Near Optimal*, *Locally Optimal*, *Locally Infeasible*, *Cutoff*, *Numerical Error*, *Undetermined*, *Unknown Error*. (See *Overview of Mathematical Modeling* for more information on these states).

**Tries:** This shows the current number of tries or iterations used in solving the model. The value is updated periodically in the course of solving.

**Infeasibility:** This shows the total amount by which all constraints are violated. When this value is reported as zero, all constraints are satisfied. However, on integer models, all integer restrictions may not be satisfied.

**Objective:** This shows the current value of the cell to be maximized or minimized.

**Solver Type:** This shows the type of specialized solver in use, if any, and will be either *Global*, *Branch-and-Bound*, or *Multistart*.

**Best Obj.:** This shows the objective value of best feasible solution found.

**Obj. Bound:** This shows the theoretical bound on the objective for integer or nonlinear programming models. *What'sBest!* initially determines this value by solving the problem without integer restrictions. It then tightens this bound as it searches more branches of the solution tree. The objective bound is useful information in that it is a limit on how good a value the objective can attain. On long-running models, you might want to interrupt the solver once the best solution is sufficiently close to the theoretical limit.

**Steps:** This shows the number of solver iterations.

**Active:** This shows the number of pending subproblems to be solved.

**Numerics:** This shows the total number of numeric cells in the model.

**Adjustables:** This shows the total number of adjustable cells in the model.

**Integers/Bin.:** This shows the number of adjustables cells with integer/binary restrictions.

**Formulas:** This shows the number of formula cells.

**Constraints:** This shows the total number of constraint cells in the model.

---

**Nonlinears:** This shows the number of adjustable cells that appear nonlinearly in the model. We say that a variable appears nonlinearly in a formula when that formula is nonlinear with respect to changes in the variable. For instance, consider the nonlinear expression  $X+Y^2$ . This expression is nonlinear with respect to  $Y$ , but it is linear with respect to  $X$ . Thus,  $Y$  would be included in the nonlinear count, while  $X$  would not.

**Coefficients:** This shows the total number of coefficients in the best cell and all formulas dependent on adjustable cells. Mathematicians refer to this as the number of nonzero elements.

**Obj. Direction:** This shows the direction of the best cell.

**Activity:** After the Verifying part, this shows the stage of the solution process the solver is currently performing.

- ◆ Extracting Data... / Check license, copy file
- ◆ Extracting Data... / Reading file
- ◆ Extracting Data... / Storing relevant formulas
- ◆ Extracting Data... / Creating Instruction List
- ◆ Building the Model...
- ◆ Solving...
- ◆ *Debugging... / Finding Infeasible Cells or Finding Unbounded Cells* if Debugger requested
- ◆ Writing Solution...

During the last stage, *What'sBest!* writes the solved values of the adjustable cells directly into your spreadsheet and writes the requested reports.

**Elapsed Runtime:** This shows the length of time the solver has been running in hours, minutes, and seconds.

---

**Note:** Variables or Optimizables is defined as the total number of adjustable cells, constraint cells, and cells containing formulas dependent on adjustable cells that are used by the objective function.

---

## Getting the Best Results

You can obtain the results of your call to solve the model by either examining the values displayed in the spreadsheet or by looking at the status report (*WB! Status*) and/or the solution report (*WB! Solution*).

In some cases, such as when you have a pretty good estimate of what the objective should be, you might feel satisfied after inspecting the best cell. However, even under such ideal conditions, it is a good idea to confirm that your model solved successfully by examining the status report. The status report provides detailed feedback about your model and the solution outcome.

If you wish a more detailed view of your model, you may request the solution report as well. The solution report provides a detailed analysis of the adjustable, best, and constraint cells, showing the initial and final values, as well as the locations of the cells. The generation of the status report and solution report is controlled by settings at the bottom of the *General Options* dialog box.

If an error or warning situation was encountered that prevented the solver from running to completion, then, by default, the solver opens up the status report to give you the error or warning message. This message describes the problem the solver encountered and offers suggestions for correcting it. The user may change the error and warning situations under which the status report is automatically opened at the bottom of the *General Options* dialog box.

---

The status report generated by solving the completed sample model *XYZ.XLS* is shown below:

MODEL INFORMATION:		
CLASSIFICATION DATA		
	Current	Capacity Limits
Total Cells	20	
Numerics	17	
Adjustables	2	Unlimited
Continuous	2	
Free	0	
Integers/Binaries	0/0	Unlimited
Constants	11	
Formulas	4	
Strings	0	
Constraints	3	Unlimited
Nonlinears	0	Unlimited

The status report is organized as follows. First, final values for the fields appearing in the solver status window are presented. At its conclusion, the status report appends critically important information such as the solution status. The fields in the report and the significance of the returned values are as follows:

**Classification Data:**

Total Cells: This shows the total number of numeric cells in the model. These are the cells useful to the model, containing the Numerics, Strings, and the Constraints.

Numerics: This shows the number of cells displaying a numeric value. These are Adjustable, Constant, and Formula cells.

Adjustables: This shows the total number of adjustable cells in the model.

Continuous: This shows the number of Adjustable cells with a continuous range [0, +infinity[.

**Free:** This shows the number of Adjustable cells with a free range, ]-infinity, +infinity[.

**Integers:** This shows the number of Adjustable cells with integer restrictions on a range [0, +infinity[.

**Binaries:** This shows the number of Adjustable cells with binary restrictions [0,1].

**Constants:** This shows the number of cells containing a constant number, or an unsupported function converted into its constant value. This does not count the constant arguments within a formula.

**Formulas:** This shows the number of cells containing a usefull formula to the model. This does not count the constant arguments within a formula.

**Strings:** This shows the number of cells containing a string of characters, or an unsupported function converted into its string value. This does not count the string arguments within a formula.

**Constraints:** This shows the total number of constraint cells in the model.

**Nonlinears:** This shows the number of adjustable cells that appear nonlinearly in the model. We say that a variable appears nonlinearly in a formula when that formula is nonlinear with respect to changes in the variable. For instance, consider the nonlinear expression  $X + Y^2$ . This expression is nonlinear with respect to  $Y$ , but it is linear with respect to  $X$ . Thus,  $Y$  would be counted in the nonlinear count, while  $X$  would not.

**Coefficients:** This shows the total number of coefficients in the best cell and all formulas dependent on adjustable cells.

**Variables:** This shows the total number of adjustable cells, constraint cells, and cells containing formulas dependent on adjustable cells that influence the best cell. This information appears after an automatic linearization.

**Minimum and Maximum coefficients:** These are the largest and smallest absolute values of coefficients appearing in the model. When the ratio of these two values becomes very large the model is said to be poorly scaled. Poorly scaled models can lead to numerical round off errors in the solver.

These values are supplied with their location to assist you in tracking them down. Note that “<RHS>” signifies the Right Hand Side of a constraint. If the location given is “...”, this means that no specific cell location is available and that the coefficient appears in a constraint added to the model as part of the linearization option.

**Model Type:** What’sBest! examines your model to determine which of six types your model falls under: *Integer/Quadratic*, *Integer/Nonlinear*, *Integer/Linear*, *Quadratic, Nonlinear*, *Linear*. For further information on these categories, see the section entitled *Linear vs. Nonlinear Expressions and Linearization*.

**Solution Status:** This field gives the status of the final solution. The list of possible states is *Globally Optimal*, *Infeasible*, *Unbounded*, *Feasible*, *Infeasible or Unbounded*, *Near Optimal*, *Local Optimal*, *Locally Infeasible*, *Cutoff*, *Numerical Error*, *Unknown*, *Unloaded*, *Loaded* and *Unknown Error*. (See *Solution Outcomes* in *Overview of Mathematical Modeling* for more information).

---



**Optimality Condition:** This shows the optimality condition for nonlinear models, either *Satisfied* or *Uncertain* (See *Solution Outcomes* for more information).

**Objective Value:** Assuming your model contains a best cell to be maximized or minimized, this field displays its final value.

**Direction:** Assuming your model contains a best cell, this field displays its direction. The direction will be listed as either *Maximize* or *Minimize*.

**Solver Type:** This shows the type of any extended solver in use over and above the standard linear and nonlinear solvers. Possible extended solvers are: *Global*, *Branch-and-Bound*, or *Multistart*.

**Tries:** This shows the current number of tries (or iterations) needed to solve the model.

**Infeasibility:** This shows the total amount by which all constraints are violated. When this value is reported as zero, all constraints are satisfied. However, on integer models, all integer restrictions may not be satisfied.

**Best Objective Bound:** Assuming a best cell is present, this shows the theoretical bound on the objective for integer programming models or any model solved with the global solver.

**Steps:** This shows the number of solver steps required by any extended solver.

**Active:** This shows the number of pending subproblems to be solved by any extended solver.

**Solution Time:** This shows the length of time the solver has been running in hours, minutes, and seconds.

Additional detailed information about your model can be found by generating a solution report. You can enable the solution report option via the *Solution Report* drop-down box on the *General Options* dialog box.

---



---

# 3 *Additional Commands*

---

What'sBest! has a number of additional commands to allow you to do such things as perform sensitivity analysis, identify integers variables, change the type or appearance of a report, or locate a particular type of cell. Others will wish to tailor the performance of the solvers by manipulating various option settings. This chapter discusses these additional commands and options.

## ***Options and Solvers***

Some options in What'sBest! pertain to the overall operating parameters of the What'sBest! solvers or to the user interface and data display. These general options (such as *Iteration limit* or *Runtime Limit*) are set in the *General Options* dialog box. Other options modulate the performance of a particular solver. For example, *Model Reduction* is a linear solver option and is set in the *Linear Solver Options* dialog box.

For most models, the default option settings should offer the best performance in a standard running environment. However, as you build more complex models, you may benefit from trying new option settings or be required to change the settings to get a valid of good solution. In order to effectively use the options, the user should understand the four-solver architecture of What'sBest! and the types of options that are available.

The four classes of solvers available in What'sBest! are linear, nonlinear, global, and integer. The downloadable and solver suite versions of What'sBest! are supplied with a linear solver, a nonlinear solver, global solver, and an integer solver. Larger versions of What'sBest! are equipped with linear and integer solvers only. A nonlinear solver and a global nonlinear solver are provided optionally for additional fees. The linear solver generally runs in primal simplex mode, but it can be set to dual simplex or the barrier method (if the barrier option is purchased).

What'sBest! options apply only to the current model. That means options are defined as Excel® names in the workbook and are not saved for other workbooks. The What'sBest! option names usually start with 'WBxxx' and thus are separated alphabetically from the user defined names. The *Reset to Default* command resets the workbook options, but not options defined in the *Advanced Parameters* window. The workbook options are *General Options*, *Linear Solver Options*, *Nonlinear Solver Options*, *Global Solver Options*, *Integer Pre-Solver Options*, *Integer Solver Options*, and *Stochastic Solver*.

The algorithms used by the solvers are as follows. The linear solver in *What'sBest!* uses either a primal simplex, dual simplex, or barrier method. The *Solver Method* default setting of *Solver decides* selects the primal simplex method. The *What'sBest!* nonlinear solver uses a generalized reduced gradient (GRG) algorithm. The *What'sBest!* global solver combines a series of range bounding techniques within a branch-and-bound framework to find global solutions to non-convex NLPs. Finally, the integer solver provided in *What'sBest!* uses a branch-and-bound algorithm, also referred to as the branch-and-bound manager.

---

## Integers...|Integer-Binary...

The *Integers...|Integer-Binary* command allows you to restrict your adjustable cells to being integers. What'sBest! allows you to define integers in either *binary* or *general* format. A binary integer will return a zero or one, whereas any nonnegative, whole number {0,1,2,3...} will be returned for a general integer. The *Integer* dialog box appears as follows:

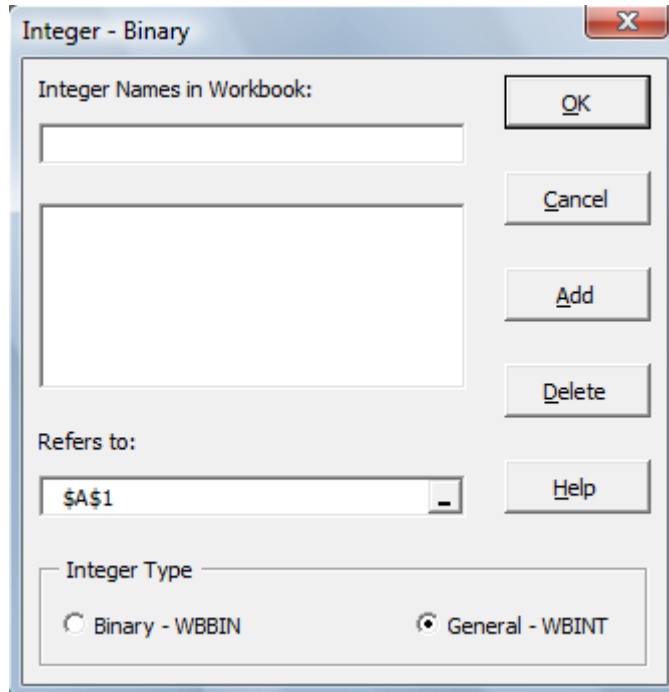

To create an integer range, specify the cell or cell range you wish to make integer in the *Refers to:* text box. Then, enter a name in the *Integer Names in Workbook:* text box. Next, select the *Binary - WBBIN* or *General - WBINT* radio button in the *Integer Type* box. Once this is done, pressing the *Add* button causes What'sBest! to assign a *WBBIN* or *WBINT* range name to the selected cells, which will appear in the list on the *Integer* dialog box.

If you decide later you would like to remove the integer restriction, simply select the *Integer* command, click on the name of the integer range to remove, and press the *Delete* button. It is important to remember that integer restrictions can increase solution times as discussed in the section entitled *Runtime Concerns*.

## *Integer Names in Workbook*

What'sBest! uses range names to specify which cells in a model should be integers. You can choose any combination of letters for your range name. When the range name is created, What'sBest! adds *WBBIN* or *WBINT* to the front of the name to represent, respectively, binary integers and general integers. For instance, if you used the name "Quantity" in the *Integer Names in Workbook*: textbox for a general integer, a range name *WBINTQuantity* would be assigned to the selected cells and appear in the list on the *Integer* dialog box.

## *Refers to*

Specify the range of cells that are to be made integer in this text box. What'sBest! will automatically fill the *Refers to*: text box in with the range of the currently selected cells. If this is not the range of cells you want, you can type the correct range in or select the button on the right edge of the text box to bring up a cursor for cell selection.

## *Binary-WBBIN*

Select the *Binary* radio button in the *Integer Type* box to cause What'sBest! to constrain the current range of cells specified in the *Refers to*: text box to have a value of zero or one. Binary integer variables (0/1) are useful in making Yes/No, Open/Close, or Buy/Sell decisions and formulating piecewise linear functions. If a cell is specified as binary, What'sBest! will find the best solution that returns a 0 or 1 in that cell.

## *General-WBINT*

Select the *General* radio button in the *Integer Type* box to cause What'sBest! to constrain the range of cells specified in the *Refers To*: text box to be a positive, whole number. General integer variables (0,1,2...) can be useful when answers with fractions are of limited or no value. Some examples are personnel scheduling, buy/sell decisions involving round lots, and discrete loading models. If a cell is specified as general integer, What'sBest! will find the best solution that returns a whole number in that cell.

## *Runtime Concerns in Integer Problems*

The use of integer variables can considerably increase the time required to find optimal solutions. In most nonlinear models that include integer variables, your chances of reaching an optimal solution in a reasonable amount of time are diminished further, unless the problem is extremely rudimentary or

---

constrained in very specific ways. To improve performance, you may wish to use options such as *Tolerance* and/or *Hurdle (Known IP)*. Such options can significantly decrease the solution time on some integer problems. For details on these options, see the section entitled *Options...|Integer Solver*.

## Integers...|Special Ordered Set

The *Integers...|Special Ordered Set* command allows you to support Special Ordered Sets (SOS) variables of type 1, 2 and 3, and Cardinality sets of variable via the following dialog box:

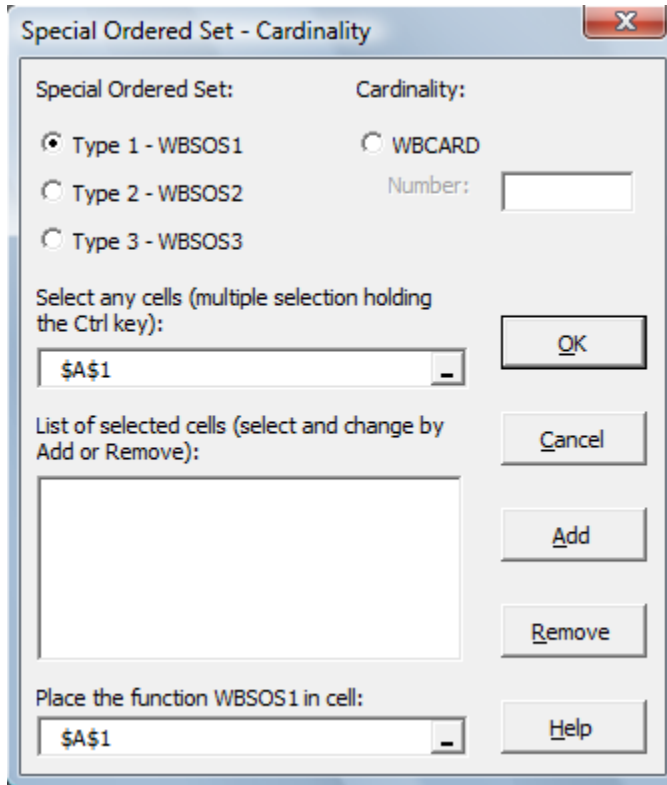

### Special Ordered Set

The properties of the three SOS types are, via the WBSOSx function:

<b>SOS Type</b>	<b>Property</b>
WBSOS1	At most one variable belonging to an SOS1 set will be > 0.

WBSOS2	At most two variables in an SOS2 set can be $> 0$ . If two variables are nonzero, then the variables will be adjacent to one another. SOS2 sets are particularly useful for implementing piecewise-linear functions in models.
WBSOS3	Exactly one variable from a given SOS3 set will be equal to 1. All remaining variables will be equal to 0.

The syntax for the WBSOSx declarations is as follows, written in the selected cell of the spreadsheet:

=WBSOS1(range reference, ...)

**Note:** Each variable in an SOS set counts against the integer variable limit imposed in limited versions of *What'sBest!*. SOS sets are supported for linear models only.

### Cardinality

Related to the SOS capability discussed above, *What'sBest!* also supports cardinality sets of variables via the WBCARD function. The cardinality feature allows you to specify a set of variables with a cardinality of  $N$ , meaning that, at most,  $N$  of the variables in the set will be allowed to be nonzero.

As with SOS sets, cardinality sets help the integer solver branch more efficiently, and they reduce the number of variables and constraints in your models.

The syntax for the WBCARD declarations is as follows, written in the selected cell of the spreadsheet:

=WBCARD(number, range reference, ...)

**Note:** Each variable in a CARD set counts against the integer variable limit imposed in limited versions of *What'sBest!*. CARD sets are supported for linear models only.



### *Select Any Cells*

This reference field allows you to select any of the Adjustable cells that will be part of the set. You can select multiple range by holding the Control (Ctrl) key. Then click on Add to store them in the List of Selected Cells field.

### *List of Selected Cells*

This field will list all the cells that are part of an SOS or CARD set. You can modify the list by clicking on Add or Remove buttons.

### *Place the Function in Cells*

Specify the host range of cell you would like to see the SOS or CARD function to be placed in the spreadsheet. *What'sBest!* automatically fills this box with the current cell selection.

If the selection already contains a WBSOSx or a WBCARD function, then *What'sBest!* will display the cells argument into the List of Selected Cells.

---

## Integers...|Semi-continuous

The *Integers...|Semi-continuous* command allows you to support Semi-continuous variables via the following dialog box:

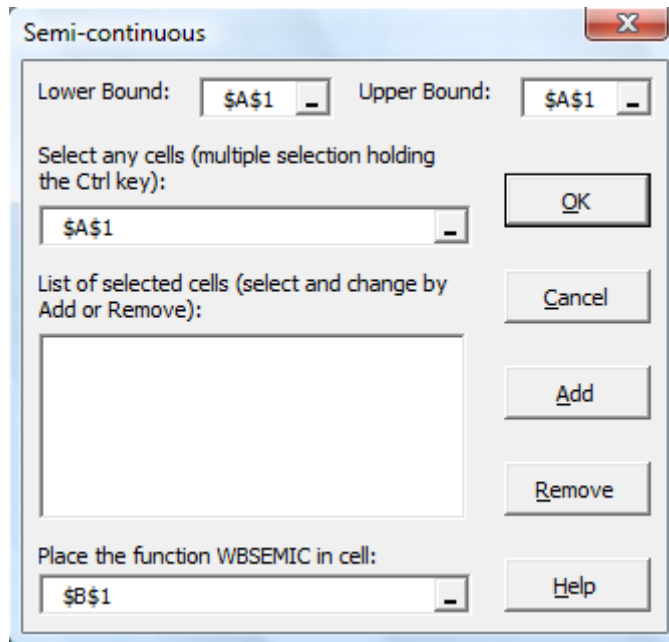

Many models require certain variables to either be 0 or lie within some nonnegative range, e.g., 10 to 20. Variables with this property are said to be semi-continuous. Modeling semi-continuity in *What'sBest!* in the past meant having to add an additional 0/1 variable and two additional constraints.

The syntax for the WBSEMIC declaration is as follows, written in the selected cell of the spreadsheet:

```
=WBSEMIC(lower bound, upper bound, range references, ...)
```

This will restrict the variable in the range references, to be either 0 or to lie within the range [lower\_bound, upper\_bound].

**Note:** Each semi-continuous variable will be counted against any integer variable limit for your installation.

### *Lower Bound, Upper Bound*

This field allows you to select the lower and the upper bounds of the Adjustable cells of the set. You can select numeric values, or cells references. These references cannot be variable numbers.

### *Select Any Cells*

This reference field allows you to select any of the Adjustable cells that will be part of the set. You can select multiple ranges by holding the Control (Ctrl) key. Then click on Add to store them in the List of Selected Cells field.

### *List of Selected Cells*

This field will list all the cells that are part of a Semi-continuous set. You can modify the list by clicking on Add or Remove buttons.

### *Place the Function in Cells*

Specify the host range of cell you would like to see the SEMIC function to be placed in the spreadsheet. What's*Best!* automatically fills this box with the current cell selection.

If the selection already contains a WBSEMIC function, then What's*Best!* will display the cells argument into the List of Selected Cells.

---

## Options...

The *Options* command allows you to customize the operating parameters of the *What'sBest!* solvers, the user interface, how *What'sBest!* runs and how your model is displayed. There are several sub-commands under the *Options* command on the *WB!* menu. They are:

- ◆ General...
- ◆ Linear Solver...
- ◆ Nonlinear Solver...
- ◆ Global Solver...
- ◆ Integer Pre-Solver...
- ◆ Integer Solver...
- ◆ Stochastic Solver
- ◆ Reset to Default

From the dialog boxes posted by these commands, you can set the options by simply selecting the options you would like and clicking the *OK* button. If you wish to restore the options to their default values, you should use the *WB!|Options...|Reset to Default* command to return all *What'sBest!* options to their default values.

---

# Options...|General

The dialog box posted by the *Options...|General* command appears as follows:

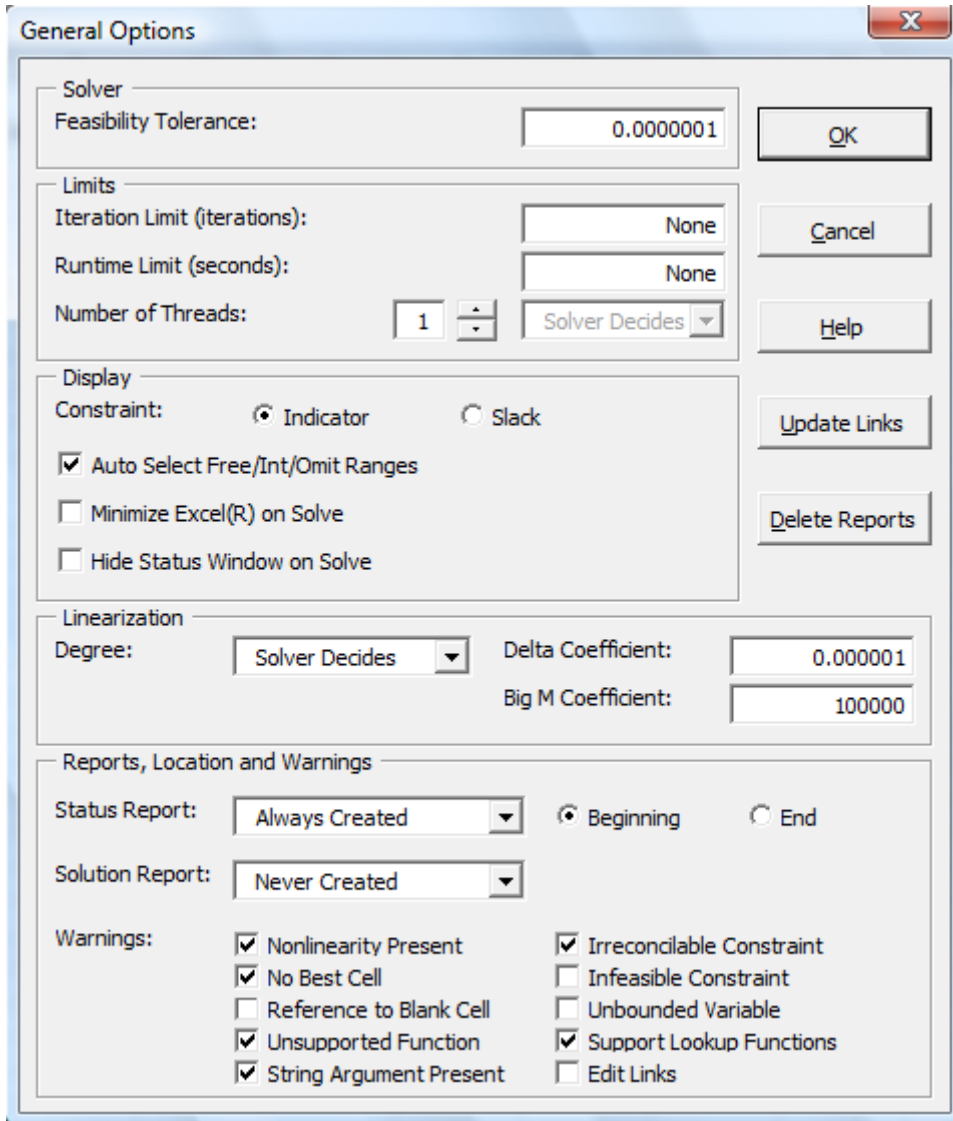

The *General Options* dialog box contains options that let you control the ways in which *What'sBest!* displays, processes, and saves information. All of the options in the *General Options* dialog are saved with the workbook and are therefore called workbook options. All workbook options are reset to default settings every time you create a new workbook. You may also use the *Reset to Default* command to return all workbook options in the current model to their default values, with the exception of the Advanced Parameters options. Discussion of the *General Options* follows below.

### *Feasibility Tolerance*

You can specify the amount of violation that will be tolerated in a model's constraints with the *Feasibility Tolerance* text box. Increasing the feasibility tolerance can allow you to find a feasible solution to a model that was previously infeasible. For example, changing a feasibility tolerance would be useful if you have a poorly scaled model with very large and very small coefficients that is nearly feasible (You would know that the model is nearly feasible if you found the slack values to be small). The best solution would be to rescale the model, but setting the feasibility tolerance offers a simpler alternative. By entering a larger feasibility tolerance, you allow the solver to tolerate slight constraint violation, such as a few pennies in a budget of tens-of-thousands, in order to reach a feasible solution.

The default value for feasibility tolerance is 0.0000001.

### *Iteration Limit*

You can specify a limit on the number of tries or iterations undertaken during the solution process with the *Iteration Limit (Iterations)* textbox. If this limit is encountered before a solution has been found, then the solution search is terminated and, if the model contains integer variables, the best integer solution found up to that point is returned. If this limit is encountered and the model does not contain integer variables, the returned solution is meaningless. Please note that returning to any previously-established best solution may take some time.

The default value is *None*, signifying that no iteration limit is imposed.

### *Runtime Limit*

You can specify the maximum amount of time in seconds the solver should spend searching for a solution with the *Runtime Limit (seconds)* text box. If this runtime limit is encountered before a solution has been found, then the solution search is terminated and, if the model contains integer variables, the best integer solution found up to that point is returned. If this limit is encountered and the model does not contain integer variables, the returned solution is meaningless. Please note that returning to any previously established best solution might take some time.

The default value is *None*, signifying that no runtime limit imposed.

### *Constraint Display*

Select Slack or Indicator to prompt *What'sBest!* to return the slack value or indicator display for the constraint cells.

---

**Indicator** mode places the sign of the equation ( $>=$ ,  $<=$ ,  $=$ ) in the constraint cell. If an indicator is tightly satisfied (i.e., the constraint contains no slack), then *What'sBest!* will return an equal sign before the indicator (i.e., " $=<=$ "). If an indicator is not satisfied at all, *What'sBest!* will return a "Not" before the indicator (i.e., "Not  $=$ ").

**Slack** mode displays the slack value of each constraint. The slack value of a constraint tells you how close you are to satisfying the constraint. A positive slack is the amount by which the constraint is overly-satisfied. A zero slack value means the constraint is exactly satisfied. A negative slack is the amount by which the constraint is violated. Computing the slack of a constraint involves simply subtracting one side of the constraint from the other side.

The default setting is indicator mode.

### *Auto Select Free/Int/Omit Ranges*

Check this option if you want the *Free*, *Integer*, or *Omit* ranges selected as you scroll through any list of *What'sBest!* defined named range names (these range names begin with WB). With this option checked (on), the range corresponding to a particular name is selected when you click on that name on the list. This enables you to easily identify the range corresponding to a particular name.

The default setting is on.

### *Minimize Excel® on Solve*

Check this option if you would like Excel® to be minimized while the *What'sBest!* solver is running.

The default setting is off.

### *Number of Threads*

This feature will tell the *What'sBest!* solver to run on multiple threads, so to allocate calculation tasks on different processes. This number can be set between 1 and 32, depending on the computer capabilities.

The default setting is 1.

There is also a choice for the threads:

**Solver Decides** - Use the best performing multithreading solver on average (either concurrent or parallel) for model type when the number of threads is greater than 1; otherwise, it runs single threaded.

**Parallel Preferred** - Prefer parallel over concurrent, but use concurrent if an appropriate parallel solver does not exist.

**Parallel Only** - The solver will run the parallel mode.

**Concurrent Preferred** - Prefer concurrent over parallel, but use parallel if an appropriate concurrent solver does not exist.

---

---

Concurrent Only - The solver will run the concurrent mode.

### *Hide Status Window on Solve*

Check this option if you would like to hide the Status Window while the *What'sBest!* solver is running.

The default setting is off.

### *Linearization*

The linearization options offer significant performance gains to some nonlinear models by replacing nonlinear operations with mathematically equivalent linear operations. An example of such performance gains may be seen in the sample model entitled *Linearization Option and Construction Cost Estimation*.

### *Degree*

Many nonlinear operations, such as  $\text{abs}(x)$  and  $\text{min}(x,y)$ , can be replaced by linear operations that are mathematically equivalent. The ultimate goal is to replace all the nonlinear operations in a model with equivalent linear ones, thus allowing you to use the faster and more robust linear solvers in *What'sBest!*. We refer to this process as *linearization*.

Specify the extent to which *What'sBest!* should attempt to linearize models with the *Degree* drop-down box. The available options here are *Solver Decides*, *None*, *Mathematical*, and *Mathematical, Logical*. Under the *None* option, no linearization occurs. With the *Mathematical* option, *What'sBest!* linearizes *ABS()*, *MAX()*, and *MIN()* function references as well as any product of binary variables and at most one continuous variable. The *Mathematical, Logical* option is equivalent to the *Mathematical* option plus it will linearize *AND()*, *IF()*, *INT()*, *NOT()*, *OR()*, *SIGN()*, *SUMIF()*, *VLOOKUP()*, and *HLOOKUP()* functions and all logical operators ( $\leq$ ,  $=$ ,  $\geq$ , and  $\Leftrightarrow$ ). Under the *Solver Decides* option, *What'sBest!* will do maximum linearization if the number of adjustable cells doesn't exceed 12. Otherwise, *What'sBest!* will not perform any linearization. *What'sBest!* defaults to using *Solver Decides*.

The linearization process may add a considerable number of constraints and variables to the mathematical program generated to optimize your model. The number of such constraints and variables added is noted in the *WB! Status* report.

### *Delta Coefficient*

You can specify how closely you want the additional constraints added as part of linearization to be satisfied with the *Delta Coefficient* text box.

*What'sBest!* defaults to a *Delta Coefficient* coefficient of 0.000001.

### *Big M Coefficient*

Specify the *Big M* value to use during linearization with this text box. When *What'sBest!* linearizes a model, it will add *forcing constraints* to the mathematical program generated to optimize your model. These forcing constraints are of the form:

---



---

$$f(\text{Adjustable Cells}) = M \cdot y$$

where  $M$  is the *Big M Coefficient* and  $y$  is a 0/1 variable. The idea being that, if some activity in the adjustable cells is occurring, the forcing constraint will drive  $y$  to take on the value of 1. Given this, if we set the *Big M* value to be too small, we may end up with an infeasible model. Therefore, the astute reader might then conclude that it would be smart to make *Big M* quite large, thereby minimizing the chance of an infeasible model. Unfortunately, setting *Big M* to a large number can lead to numerical roundoff problems in the solver resulting in infeasible or sub-optimal solutions. So, getting a good value for the *Big M Coefficient* may take some experimenting.

The default value for *Big M* is 100,000.

## Status Report

Use the Status Report option to specify under what conditions, if any, you would like a status report created when a model is solved. The available options here are: *Always Created*, *Never Created*, *Only on Error/Warning*. If you select *Always Created*, What'sBest! will insert a status report worksheet entitled *WB! Status* into the current workbook every time you solve. The *Never Created* selection means that What'sBest! will not insert a status report. By selecting *Only on Error/Warning*, What'sBest! will insert a status report worksheet entitled *WB! Status* only if an error or warning from calculation is encountered. If there are no errors or warnings, then no status report is inserted.

The status report contains the model's classification statistics, options selected, and any error messages or warnings generated during the last attempt to solve the model. To view the status report, just click on the *WB! Status* tab of your workbook. The information presented in the status report is discussed in the *Solve* section or the *Solution Outcomes* section in *Overview of Mathematical Modeling*.

The What'sBest! default is *Always Created*, meaning that a status report is created and inserted into the workbook upon each solve.

## Solution Report

Select the *Solution Report* checkbox to tell What'sBest! you would like a solution report created when the model is solved. The next time you solve, What'sBest! will generate a worksheet called *WB! Solution* containing a listing of the ABC cells and their locations, types, values, and formulas, as well as sensitivity analysis (dual values) for the adjustable and constraint cells, or the detailed report with the objective coefficients ranges. Click on the *WB! Solution* tab to see the solution report.

The default is not to create a solution report.

---

Here's an example of the solution report “*WB! Solution*” for the XYZ sample model covered earlier:

OBJECTIVE	CELL	VALUE	INITIAL VALUE	TYPE	REDUCED COST	DECREASE
MAXIMIZE	XYZ!G6	3.300000e+004	0.000000e+000			
COEFFICIENTS						
	XYZ!C5		3.000000e+002			5.000000
	XYZ!D5		5.000000e+002			5.000000
ADJUSTABLE	CELLS	VALUE	INITIAL VALUE	TYPE	REDUCED COST	DECREASE
	XYZ!C5	6.000000e+001	0.000000e+000	C	0.000000e+000	+Infinity
	XYZ!D5	3.000000e+001	0.000000e+000	C	0.000000e+000	+Infinity

Note that creating solution reports may dramatically increase runtimes on large models.

### *Beginning or End*

Select the *Beginning* or *End* radio button to tell *What'sBest!* whether to place any reports (status and/or solution report) at the beginning of the worksheet tabs (far left) or at the end of all worksheet tabs (far right).

The default is to insert the reports at the *Beginning*.

## Warnings

These checkboxes allow you to select the warnings you wish to display in the status report. The warnings are:

- ◆ *Nonlinearity Present* - warning that nonlinear functions or formulas are present in the model. Nonlinear functions can adversely affect the speed and performance of the *What'sBest!* solver. When possible, nonlinearities should be avoided. See *Overview of Mathematical Modeling* for a discussion of nonlinear relationships.
- ◆ *No Best Cell* - warning that no objective (best cell) is specified for the model. The omission of a best cell may be intentional (e.g., in a goal seeking model) or unintentional (e.g., in an optimization model).
- ◆ *Reference to Blank Cell* - warning that blank cells are referenced in formulas. The reference of a blank cell in a formula may be intentional (e.g., summing across a large range that contains a few blank cells) or unintentional (e.g., accidentally referencing A21 instead of A12).
- ◆ *Unsupported Function* - warning that an unsupported function appears in the model. The value of a cell containing an unsupported function will not be recalculated during the solution process.
- ◆ *String Argument Present* - warning that a text argument appears in a function that is expecting a numeric argument. Unexpected text arguments are treated as if they have a numeric value of zero.
- ◆ *Irreconcilable Constraint* - warning that a violated constraint does not depend upon adjustable cells, and, therefore, cannot be reconciled.
- ◆ *Infeasible Constraint* - warning that the debugger feature will list the infeasible constraints. These constraints are contributing to the infeasibility of the model.
- ◆ *Unbounded Variable* - warning that the debugger feature will list the unbounded variables. These constraints are contributing to unbound the model.
- ◆ *Support Lookup Functions* - warning that the Lookup functions will be read and processed; otherwise, these functions will be treated as unsupported functions.

The default is to display all warnings except the *Reference to Blank Cell* and the *Infeasible Constraint debugger* warnings.

## Update Links

Select the *Update Links* button to update all *What'sBest!* functions in the current workbook to point to the present location of the *What'sBest!* add-in file (WBA.XLA or WBA.XLAM).

When a file is opened that contains *What'sBest!* functions created on a system in which the *What'sBest!* program files were in a different location, Excel® displays a message about "automatic links" and asks: "Update all Linked Information?". You may reply *No* to this dialog box given that the Excel® link update won't update the links to the *What'sBest!* add-in. If you now look at a cell containing one of the *What'sBest!* functions, you will see that it contains the path of the *What'sBest!* add-in file at the time the function was created. For example, a function of the form:

---

```
=WB(A1,"<=",B1)
```

has a prepended path and appears something like this:

```
='C:\PROGRAM FILES\MICROSOFT OFFICE\OFFICE10\LIBRARY\wba.xla'WB(A1,"<=",C1)
```

Or in Excel® 2007:

```
='C:\PROGRAM FILES\MICROSOFT  
OFFICE\OFFICE12\LIBRARY\LINDOWB\wba.xlam'WB(A1,"<=",C1)
```

In the case of the sample model files, the prepended path may not coincide with the path to your *What'sBest!* add-in file. For this reason, Excel® prompts you to update links and, after declining this, you should use the *What'sBest! Update Links* button (in the *General Options* dialog box). The *Update Links* command in *What'sBest!* finds the path to your *What'sBest!* add-in file and then returns the equations to the previous form without a prepended path. If you leave the paths in their incorrect form, then Excel® fails to find your *What'sBest!* add-in file and it inserts an error code of #REF! into each of the cells having an incorrect path.

After updating is completed, the workbook/sheet should be saved.

### Delete Reports

Click on the *Delete Reports* button to remove the *WB! Status*, the *WB! Solution*, *WB! Stochastic* and the *WB! Histogram* reports from the workbook you have open. The next time you solve the model, new reports will be generated according to your specifications in the *Status Report* and the *Solution Report* drop-down boxes. You might want to use the *Delete Reports* button if you have already solved the model and want to save it without the *What'sBest!* reports, especially when the reports are at the end of many worksheets.

---

## Options...|Linear Solver

The dialog box posted by the *Options...|Linear Solver* command appears as follows:

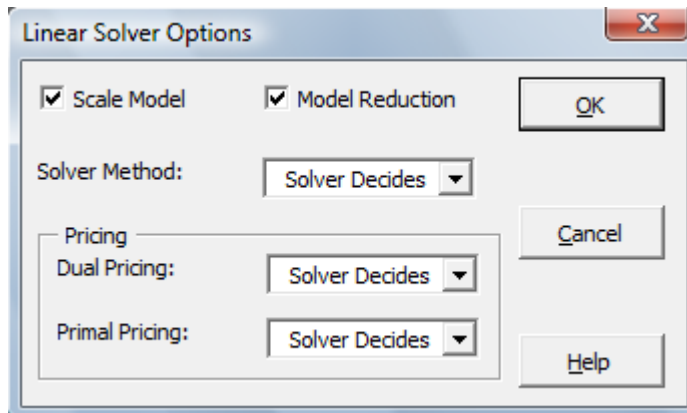

This command allows you to set a number of options controlling the function of the linear solver.

## Scale Model

Select the *Scale Model* checkbox to rescale the matrix coefficients, so the ratio of the largest to the smallest coefficients is reduced. Rescaling reduces the likelihood of roundoff error and thereby promotes numerical stability and accuracy.

The default setting is to enable scaling.

## Model Reduction

Enable the *Model Reduction* checkbox to have the solver identify and remove extraneous variables and constraints from the formulation before solving. In some cases, this greatly reduces the size of the model to be solved to the user's benefit. In other cases, reduction only adds to the solution time without significantly decreasing the size of the model. Because *Model Reduction* can offer significant improvement in performance, this is one of the more significant options. However, it is extremely difficult to predict whether a model will solve better or worse with reduction, so the user is advised to try both settings to determine which setting offers better performance.

The default is to enable reduction.

## Solver Method

Indicate the method you would like the linear solver in *What'sBest!* to employ using the *Solver Method* drop-down box. Possible choices include: *Solver Decides*, *Primal Simplex*, *Dual Simplex*, and *Barrier*. The simplex method moves along the surface of the feasible region toward the optimal solution while the barrier method moves through the interior region. The *Solver Decides* setting currently defaults to the primal simplex method.

As a rough guideline, primal simplex tends to do better on sparse models with fewer rows than columns. Dual simplex tends to do well on sparse models with fewer columns than rows. The barrier method is most effective on densely structured or very large models.

The barrier method is an optional feature in *What'sBest!*. However, most versions ship with a 30-day trial license for the barrier solver. If your version of *What'sBest!* doesn't currently include the barrier option, you may add it at any time. Please contact LINDO Systems for information. If the barrier solver is chosen without a license, *What'sBest!* will default to using the primal simplex method.

The default setting for *Solver Method* is *Solver Decides*.

## Pricing

Select the type of pricing for the dual simplex and primal simplex algorithms in the *Dual Pricing* and *Primal Pricing* drop-down boxes, respectively. Pricing is a way of assessing the relative attractiveness of variables for selection in the simplex algorithm.

---

### Dual Pricing

One pricing algorithm for dual simplex is called *Partial*, according to which the dual simplex solver prefers variables offering the highest absolute rate of improvement toward the objective. This preference is acted upon regardless of how far other variables have to move in tandem with the chosen variables. Since these other variables may quickly hit a bound, the resulting gain for the objective may actually be quite small. The pricing mode called *Steepest Edge* takes a different approach of more painstakingly selecting variables according to the actual improvement in the objective. Because the objective's gain is higher per iteration with *Steepest Edge*, fewer iterations—of somewhat longer duration—are required.

The default value for *Dual Pricing* is *Solver Decides*.

### Primal Pricing

For the primal simplex algorithm, there are two primary methods. The *Partial* method prices a small subset of variables each iteration and intermittently prices out all the variables to determine a new subset of interesting variables. *Devex* prices out all columns during each iteration using a steepest-edge approximation. Use of the thorough steepest-edge algorithm means that *Devex* results in fewer overall iterations, though each iteration is longer than it would be under the *Partial* method. *Devex* is useful with degenerate models, but it is generally difficult to predict in advance what method to use.

The default value for Primal Pricing is *Solver Decides*.

---

## Options...|Nonlinear Solver

This command allows you to set a number of options controlling the nonlinear solver. The dialog box posted by the *Options...|Nonlinear Solver* command appears as follows:

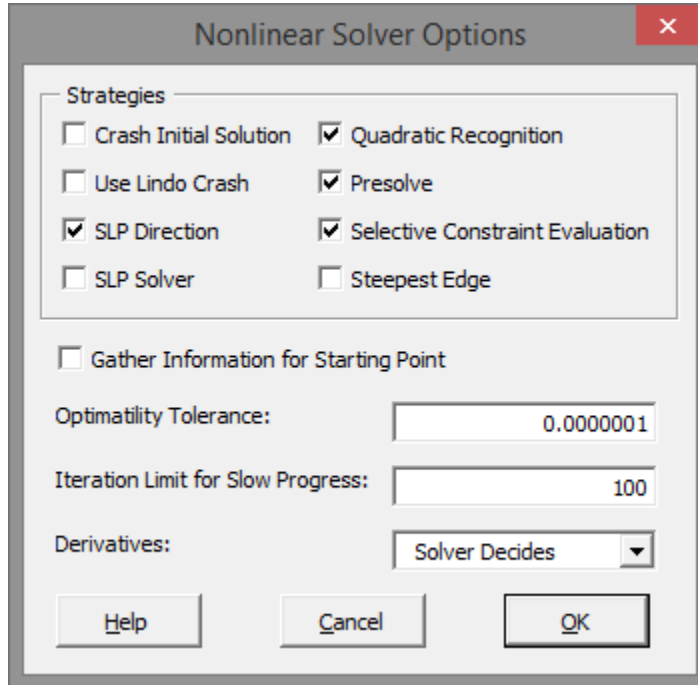

The nonlinear solver is an option on larger versions of *What'sBest!*. You can try the nonlinear solver in the Demo version of *What'sBest!* or contact LINDO Systems to purchase a nonlinear solver license for a larger version. For more information regarding the difference between linear and nonlinear models, see *Linear vs. Nonlinear Expressions and Linearization*.

### *Crash Initial Solution / Use LINDO Crash*

Check the Crash Initial Solution or Use LINDO Crash checkbox to have *What'sBest!*'s nonlinear solver invokes a heuristic for generating a "good" starting point when solving a model. If this initial point is relatively good, subsequent solver iterations should be reduced along with overall runtimes. The two checkboxes invoke two different internal strategies for the purpose of collecting data.

The default setting for Crash Initial Solution and Use LINDO Crash is off.

## *SLP Direction*

Check the *SLP Direction* checkbox to have What'sBest!'s nonlinear solver use *successive linear programming* (SLP) techniques to compute new search directions. This technique uses a linear approximation in search computations in order to speed iteration times.

In general, the number of total iterations will tend to rise when this method is used. However, runtimes will tend to be shorter.

The default setting for *SLP Direction* is on.

## *SLP Solver*

The nonlinear solver is provided with a SLP Solver. The user is advised to try this solver which may offer better performance for some models. This option should not be used with the Multistart feature of the Global Solver.

The default setting for the *SLP Solver* is off.

## *Quadratic Recognition*

Check the *Quadratic Recognition* checkbox to have What'sBest!'s nonlinear solver use algebraic preprocessing to determine if an arbitrary nonlinear model is actually a quadratic programming (QP) model. If a model is found to be a QP model, then it can be passed to the faster barrier or conic solver. Note that the QP solver is not included with the standard version of What'sBest!, but comes as part of the barrier option.

The default setting for *Quadratic Recognition* is on.

## *Presolve*

Check the *Presolve* checkbox to have What'sBest!'s nonlinear solver identify and remove extraneous variables and constraints from the formulation before solving. In some cases, this greatly reduces the size of the model, thus reducing the solving time.

The default setting for *Presolve* is on.

## *Selective Constraint Evaluation*

Check the *Selective Constraint Evaluation* checkbox to have What'sBest!'s nonlinear solver evaluate constraints only on an as needed basis. Thus, not every constraint will be evaluated each iteration. This generally leads to faster solution times, but can also lead to problems in models that have functions that are undefined in certain regions.

For example, What'sBest! may not evaluate a constraint for many iterations only to find that the solver has moved to a point in a region where the constraint is no longer defined. In this case, there may not

---



be a valid point for the solver to retreat to and the solution process terminates with an error. Turning off *Selective Constraint Evaluation* eliminates these errors.

The default setting for *Selective Constraint Evaluation* is on.

## Steepest Edge

When *What'sBest!* is not in *Steepest-Edge* mode, the nonlinear solver will tend to select variables that offer the highest *absolute* rate of improvement to the objective, regardless of how far other variables may have to move per unit of movement in the newly introduced variable. The problem with this strategy is that other variables may quickly hit a bound resulting in little gain to the objective. When the steepest-edge option is enabled, the nonlinear solver spends a little more time in selecting variables by looking at the rate at which the objective will improve *relative* to movements in the other nonzero variables. Therefore, on average, each iteration will lead to larger gains in the objective. In general, the *Steepest-Edge* option will result in fewer iterations. However, each iteration will take longer.

The default setting for *Steepest Edge* is off.

## Starting Point

The *Gather Information for Starting Point* option may be useful when solving nonlinear models. This option computes the slack values for the constraint cells and uses these values internally to compute an improved starting point. After solving, the spreadsheet goes back to the original Slack/Indicator display.

The default value for *Gather Information for Starting Point* is off.

## Optimality Tolerance

Specify the *Optimality Tolerance* in this text box. The nonlinear solver operates by taking each variable and making small changes to assess the rate of improvement in the objective function. The nonlinear solver's *Optimality Tolerance* is a tolerance placed upon that rate of improvement calculation for the objective function.

If, for a given variable, the computed value proves to be less-than-or-equal-to the *Optimality Tolerance*, then the solver does not attempt further adjustments to that variable's value. Decreasing the *Optimality Tolerance* toward zero will tend to make the solver run longer, but may lead to better solutions to poorly-formulated or poorly-scaled models.

The default setting for *Optimality Tolerance* is 0.0000001.

---

## *Iteration Limit for Slow Progress*

Specify an integer limit upon the number of successive iterations made without a significant improvement in the objective function in the *Iteration Limit for Slow Progress* text box. In other words, if the value has not improved by the  $N$ th iteration ( $N$  having been set as the *Iteration Limit for Slow Progress*), then the solver terminates the solution process. In cases when the model has a "flat" objective function around the optimal solution, a large iteration limit may be required to allow for sufficient iterations to move to the optimal solution.

The default setting for the *Iteration Limit for Slow Progress* is 100.

## *Derivatives*

Use the drop down menu to control the derivative method in the nonlinear solver. There are two different methods to use: *Numerical* or *Analytical* derivatives. Numerical derivatives are computed using finite differences. There are two choices available: *Central Differences* and *Forward Differences*. Analytical derivatives are computed directly by symbolically analyzing the arithmetic operations in a constraint. Again, the two choices are *Backward Analytical*, and *Forward Analytical*.

By default, *What'sBest!* uses backward analytical derivatives. However, different derivatives can improve speed and precision on many nonlinear models. Experimenting with the various derivative options may be required to determine which method works the best for a particular model.

The default setting for the *Derivatives* is 0 or *Solver Decides*.

---

## Options...|Global Solver

The dialog box posted by the *Options...|Global Solver* command appears as follows:

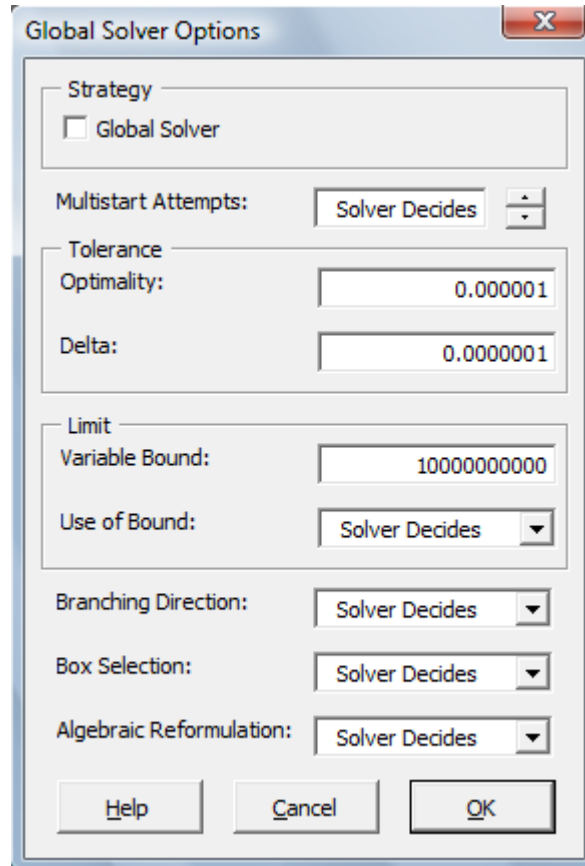

This command allows you to set a number of options controlling the function of the global solver.

## Global Solver

Check the *Global Solver* checkbox to have the global solver partition the original nonconvex/nonlinear problem into several convex/linear subproblems. The global solver will then use a branch-and-bound technique to exhaustively search over these subproblems for the globally optimal solution. The global solver will rigorously find a global optimum if allowed to run to completion. But be aware that runtimes may increase dramatically (particularly on large models) when selecting the global option.

For more information on the concept of global versus local optimality refer to section *Local Optima vs Global Optima*.

The default setting for *Global Solver* is off.

## Multistart Attempts

Use the *Multistart Attempts* text box to have the *What'sBest!*'s nonlinear solver invoke a heuristic for generating multiple good starting points. The multistart capability is useful for quickly finding better solutions when a non-convex model has several local optima.

**Note:** The multistart capability is an optional component of the *What'sBest!* solver and is packaged as part of the global solver option. Your particular installation may not have the global option enabled, in which case enabling *Multistart Attempts* will cause a warning to be generated when solving. If you are interested in adding the multistart capability, please contact LINDO Systems.

The default setting for *Multistart Attempts* is *Solver Decides*.

## Optimality

Specify the global solver's optimality tolerance in the *Optimality* text box in the *Tolerance* box. This tolerance indicates that candidate solutions must beat the incumbent solution by at least this amount to become the new best solution.

The default setting for *Optimality* is 0.000001.

## Delta

Specify the delta tolerance the global solver's convexification process in the *Delta* text box in the *Tolerance* box. This tolerance is a measure of how closely the additional constraints added as part of convexification should be satisfied.

The default setting for *Delta* is 0.0000001.

---

## Variable Bound

Specify the maximum magnitude of variable bounds used in the global solver's convexification process in the *Variable Bound* text box in the *Limit* box. Any variable bound with a magnitude in excess of this value will be truncated to this setting. Setting this parameter appropriately helps the global solver focus on more productive domains.

The default setting for *Variable Bound* is 10000000000.

## Use of Bound

Specify how to impose the above variable bound limit on the model variables in the *Use of Bound* drop-down box in the *Limit* box. Possible values are: *Solver Decides*, *None*, *All Variables*, or *Selected Variables*.

The default setting for *Use of Bound* is 0 or *Solver Decides*.

## Branching Direction

Specify the direction to branch first when branching on a variable with the *Branching Direction* drop-down box. The branch variable is selected as the one that holds the largest magnitude in the measure. Possible values are: *Solver Decides*, *Absolute Width*, *Local Width*, *Global Width*, *Global Distance*, *Absolute Violation*, or *Relative Violation*.

The default setting for *Branching Direction* is 0 or *Solver Decides*.

## Box Selection

Specify the node selection rule for choosing between all active nodes in the global solver's branch-and-bound tree in the *Box Selection* drop-down box. Possible values are: *Solver Decides*, *Depth First*, *Worst Bound*, or *Best Bound*.

The default setting for *Box Selection* is 0 or *Solver Decides*.

## Algebraic Reformulation

Control the extent of algebraic reformulation (e.g., whether  $x^*(y+x)$  is replaced by  $x^*y+x^2$ ) with the *Algebraic Reformulation* drop-down box. The algebraic reformulation process is crucial in building a tight convex envelope to enclose the nonlinear/nonconvex functions, thereby helping to improve overall convergence. Possible values are: *Solver Decides*, *None*, *Minimum*, *Medium*, or *Maximum*.

The default setting for *Algebraic Reformulation* is *Solver Decides*.

---

**Note:** The global solver needs the nonlinear option and the mixed integer option to operate

---

## Options...|Integer Pre-Solver

The dialog box posted by the *Options...|Integer Pre-Solver* command appears as follows:

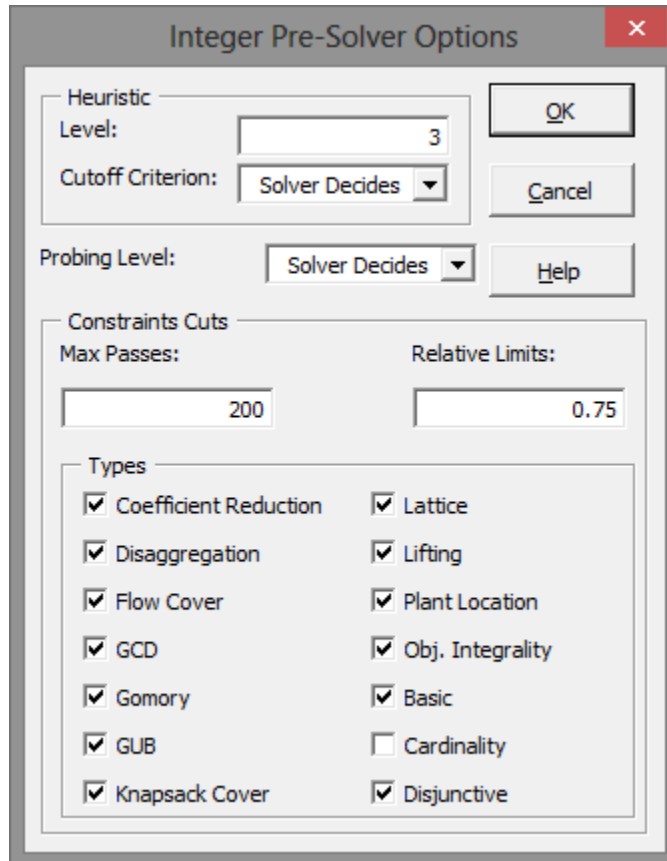

This command allows you to set a number of options controlling the function of the integer pre-solver.

Integer programming models are inherently difficult to solve. This is due to the many possible combinations of values that the integer variables may assume. In fact, the possible number of combinations grows *exponentially* with the number of integer variables. Given this rate of growth in complexity, it doesn't take a whole lot of integer variables to create a problem that is very tough to solve. The integer pre-solver carefully examines integer models using a number of heuristic procedures. The goal of these procedures is to reduce the number of integer variable combinations that need to be examined. In some cases, the pre-solver can deduce a model's solution without the need to pass it on to the full-blown integer solver.

---

The integer pre-solver options available to the user are listed below.

## *Heuristics Level*

Use the *Heuristics Level* drop-down box to control the level of integer programming heuristics. These heuristics use the continuous solution at each node in the branch-and-bound tree to attempt to quickly find a good integer solution. If an integer solution better than the incumbent is found, then it is used to fix or tighten, global and local variable bounds.

There are four options available: *None*, *Low*, *Medium*, and *High*. The *None* option disables heuristics. The remaining three options allow you to set the level of the amount of heuristics performed to a low, medium, or high level.

What's*Best!* defaults to performing a high level of heuristics.

## *Heuristics Cutoff Criterion*

The *Heuristic Cutoff Criterion* is used to control the criterion for terminating heuristics. Choices here are *Solver Decides*, *Time*, and *Iterations*. Under the *Time* setting, What's*Best!* terminates heuristics after a certain amount of elapsed time. The *Iterations* option terminates heuristics after a certain number of iterations. In general, the *Time* setting results in the fastest performance. However, due to shifting computational loads on a machine, solution paths may change under the *Time* setting from one solve to the next, potentially resulting in non-reproducible solutions. If reproducibility of a runs is a concern, then the *Iterations* option should be selected. Under the *Solver Decides* setting, What's*Best!* chooses the most appropriate strategy. What's*Best!* defaults to *Solver Decides*.

## *Probing Level*

Specify the level to which you would like probing applied to your model with the *Probing Level* drop-down box. *Level 1* is the lowest level of probing, while *Level 9* is the highest. Setting the *Probing Level* to *None* will turn probing off.

The *Probing Level* option is applicable to mixed integer linear models. Probing examines the integer variables to deduce tighter variable bounds and right-hand side values. This process is referred to as tightening the formulation and can result in the integer variables taking on values that are closer to being integral when the continuous relaxation of the model is solved. Probing can often tighten an integer model enough to dramatically speed solution times. In other cases, probing cannot adequately tighten a model and the expense of the probing step simply slows down the overall solution time.

---

Settings are:

- ◆ None: no probing,
- ◆ Level 1: minimum, simple presolving,
- ◆ Level 2: probing,
- ◆ Level 3: coefficient reduction,
- ◆ Level 4: elimination,
- ◆ Level 5: dual reductions,
- ◆ Level 6: use dual information,
- ◆ Level 7: binary row presolving,
- ◆ Level 8: row aggregation,
- ◆ Level 9: maximum pass.

The default setting for *Probing Levels* is *Solver decides*, which results in the solver setting probing to a level it believes will offer the best result.

---



## Constraint Cuts

The options contained in the *Constraint Cuts* box on the *Integer Pre-Solver* dialog box:

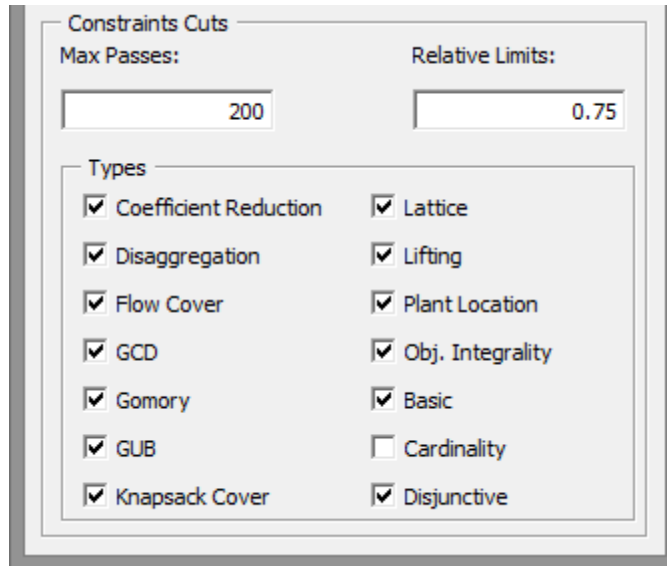

can be used to influence the solver's cut generation phase on linear models.

What'sBest!'s integer programming pre-solver performs extensive evaluation of your model in order to add constraint cuts. Constraint cuts are used to "cut" away sections of the feasible region of the continuous model (i.e., the model with integer restrictions dropped) that are not contained in the feasible region to the integer model. On most integer models, this will accomplish two things. First, solutions to the continuous problem will tend to be more naturally integer. Thus, the branch-and-bound solver will have to branch on fewer variables. Secondly, the bounds derived from intermediate solutions will tend to be tighter, allowing the solver to "fathom" (i.e., drop from consideration) branches higher in the branch-and-bound tree. These improvements should dramatically speed solution times on most integer models.

### Max Passes

Set the maximum number of passes allowed by the integer pre-solver to any non-negative, integer value with the *Max Passes* text box. The integer pre-solver makes iterative passes through a model determining appropriate constraint cuts to append to the formulation. In general, the benefit of each successive pass declines. At some point, additional passes will only add to the total solution time. Thus, What'sBest! imposes a limit on the maximum number of passes. The default limit is 200 passes.

### Relative Limit

Set the relative constraint cut limit by changing it to any desired fractional value with the *Relative Limits* text box. Most integer programming models benefit from the addition of some constraint cuts. However, at some point additional cuts take more time to generate than they save in solution time. For this reason, *What'sBest!* imposes a relative limit on the number of constraint cuts that are generated. The default limit is set to 0.5 times the number of true constraints in the original formulation.

### Types

Enable or disable any of the different strategies *What'sBest!* uses for generating constraint cuts with the checkboxes in the *Types* box. It is beyond the scope of this help file to go into the details of the various strategies. Interested readers may refer to any good text on integer programming. *What'sBest!* defaults to enabling all cut generation strategies: *Coefficient Reduction, Disaggregation, Flow Cover, GCD, Gomory, GUB, Knapsack Cover, Lattice, Lifting, Plant Location, Objective Integrality, Basic, Cardinality, Disjunctive*.

---

## Options...|Integer Solver

The dialog box posted by the *Options...|Integer Solver* command appears as follows:

The dialog box titled "Integer Solver Options" contains the following settings:

- Branching:** Direction: Both
- Integrity:** Absolute: 0.000001, Relative: 0.000008
- Linear Solver:** Warm Start: Solver Decides, Cold Start: Solver Decides
- Optimality:** Absolute: 0, Relative: 0.00001, Time to Relative: 100
- Tolerances:** Hurdle: None, Node Selection: Solver Decides, Strong Branch: 10
- K-Best Solutions:** Desired Number: 1, Specify Reporting Cells (button), Create Report (checkbox, unchecked)
- Branch-and-Price Solver:** Blocks: Off, Heuristic: GP1

Buttons at the bottom: Help, Cancel, OK.

This command allows you to set a number of options controlling the function of the integer solver.

To understand the operation of the integer options, it is useful to understand how integer problems are normally solved. With the default option settings, *What'sBest!* solves integer problems using the following steps:

1. What'sBest! begins by solving the *continuous relaxation* (i.e. the original model with integer restrictions removed). This gives an optimistic bound on the objective of the true integer model, because the objective of the integer-restricted model could never be better than the objective of the continuous approximation.
2. After solving the continuous relaxation, What'sBest! uses a process called *branch-and-bound* to find the optimal integer solution. Branch-and-bound implicitly enumerates all possible integer solutions in an intelligent fashion, minimizing the number of solutions that have to be explicitly examined. However, the number of potential solutions grows exponentially with the number of integer adjustable cells. Thus, models with a large number of integers may take a *very long time* to solve.

Options such as the optimality tolerances set limits upon how exhaustively this branch-and-bound search will be carried out. *Optimality Tolerance* is particularly useful in some integer problems as a means of significantly decreasing the solution time.

## Branching Direction

Use the *Direction* drop-down box in the *Branching* box to govern the preferred direction of branching. Branching occurs when the branch-and-bound manager forces an integer variable that is currently fractional to an integer value. When the branching direction is set to *Up*, the branch-and-bound manager will branch on a fractional integer variable by first forcing it to the next largest integer. The reverse is true when this option is set to *Down*. When the option is set to *Both*, the branch-and-bound manager makes an educated guess as to the best initial branching direction for each fractional variable.

The default setting is *Both*.

## Integrity

Due to the potential for round-off error on digital computers, it is not always possible to find exact integer values for the integer variables. The two tolerances in the *Integrity* box, *Absolute* and *Relative*, control the amount of deviation from integrality that will be tolerated.

### Absolute

Specify the absolute amount of violation from integrality that is acceptable in the *Absolute* text box. Specifically, if  $I$  is the closest integer value to  $X$ ,  $X$  will be considered an integer if:

$$|X - I| \leq \text{Absolute Integrity Tolerance.}$$

The default value for this tolerance is .000001. Although one might be tempted to set this tolerance to 0, this may result in feasible models being reported as infeasible.

### Relative

Specify the relative amount of violation from integrality that is acceptable in the *Relative* text box. Specifically, if  $I$  is the closest integer value to  $X$ ,  $X$  will be considered an integer if:

$$\frac{|X - I|}{|X|} \leq \text{Relative Integrity Tolerance.}$$

---

The default value for the relative integrality tolerance is .000008. Although one might be tempted to set this tolerance to 0, this may result in feasible models being reported as infeasible.

## LP Solver

When solving a mixed linear integer programming model, the branch-and-bound solver solves a linear programming (LP) model at each node of the solution tree. You may choose between the primal simplex, dual simplex, or barrier (assuming the barrier option was purchased with your license) solver for handling these linear programs. The two options in the *LP Solver* box, *Warm Start* and *Cold Start*, control this choice of LP solver based on whether there is a starting basis (warm start) or no starting basis (cold start).

### Warm Start

Use the *Warm Start* option to control the linear solver that is used by the branch-and-bound solver at each node of the solution tree when a starting basis is present to use as an initial starting point. The *Cold Start* option, discussed below, determines the solver to use when a previous solution does not exist. The available options are:

- ◆ *Solver Decides* – What'sBest! chooses the most appropriate solver.
- ◆ *Barrier* – What'sBest! uses the barrier method, assuming you have purchased a license for the barrier solver. Otherwise, the dual solver will be used.
- ◆ *Primal* – The primal solver will be used exclusively.
- ◆ *Dual* – The dual solver will be used exclusively.

In general, *Solver Decides* will yield the best results. The barrier solver can't make use of a pre-existing solution, so *Barrier* usually won't give the best results. In general, *Dual* will be faster than *Primal* for reoptimization during branch-and-bound.

### Cold Start

Use the *Cold Start* option to control the linear solver that is used by the branch-and-bound solver at each node of the solution tree when a previous solution is not present. The *Warm Start* option, discussed above, determines the solver to use when a previous solution does exist. The available options are:

- ◆ *Solver Decides* – What'sBest! chooses the most appropriate solver at each node.
  - ◆ *Barrier* – What'sBest! uses the barrier method, assuming you have purchased a license for the barrier solver. Otherwise, the dual solver will be used.
  - ◆ *Primal* – The primal solver will be used exclusively.
  - ◆ *Dual* – The dual solver will be used exclusively.
-

In general, *Solver Decides* will yield the best results. However, experimentation with the other options may be fruitful.

## Optimality

The *Optimality* box contains three tolerances: *Absolute*, *Relative*, and *Time to Relative*. These tolerances allow you to tradeoff solution time vs. solution quality. Ideally, we'd always want the solver to find the best solution to a model. Unfortunately, integer programming problems are very complex and the extra computation required to find an optimum solution can be prohibitive. On larger integer models, the alternative of getting a solution within a few percentage points of the true optimum after several minutes of runtime, as opposed to the true optimum after several days, makes the use of these tolerances quite attractive.

### Absolute

Use the *Absolute* text box to set the absolute optimality tolerance. This is a positive value  $r$ , indicating to the branch-and-bound solver that it should only search for integer solutions with objective values at least  $r$  units better than the best integer solution found so far. In many integer programming models there are huge numbers of branches with roughly equivalent potential. This tolerance helps keep the branch-and-bound solver from being distracted by branches that can't offer a solution significantly better than the incumbent solution.

In general, you shouldn't have to set this tolerance. Occasionally, particularly on poorly formulated models, you might need to increase this tolerance slightly to improve performance. In most cases, you should experiment with the relative optimality tolerance (discussed below) in order to improve performance.

The default value for the *Absolute* optimality tolerance is 0.0.

### Relative

Use the *Relative* text box to set the relative optimality tolerance. This is a value  $r$ , ranging from 0 to 1, indicating to the branch-and-bound solver that it should only search for integer solutions with objective values at least  $100*r\%$  better than the best integer solution found so far. The end results of modifying the search procedure in this way are twofold. First, on the positive side, solution times can be improved tremendously. Second, on the negative side, the final solution obtained by *What'sBest!* may not be the true optimal solution. You will, however, be guaranteed the solution is within  $100*r\%$  of the true optimum on linear integer models.

Typical values for the relative optimality tolerance would be in the range .01 to .05. In other words, you would be happy to get a solution within 1% to 5% of the true optimal value. On large integer models, the alternative of getting a good solution within a few percentage points of the true optimum after several minutes of runtime, as opposed to the true optimum after several days, makes the use of this tolerance quite attractive.

The default value for the relative optimality tolerance is 0.00001.

---

**Note:** Generally speaking, increasing the relative optimality tolerance is the change that will most likely improve runtimes on integer models.

---

## Time to Relative

If an integer programming model is relatively easy to solve, then we would like to have the solver press on to the true optimal solution without immediately resorting to a relative optimality tolerance (discussed above). On the other hand, if after running for a while, it becomes apparent that the optimal solution won't be immediately forthcoming, then we might want the solver to switch to using a relative optimality tolerance. The *Time to Relative* tolerance can be used in this manner. This tolerance is the number of seconds before the branch-and-bound solver begins using the relative optimality tolerance. So, for the first  $n$  seconds, where  $n$  is the value of the *Time to Relative* tolerance, the branch-and-bound solver will not use the relative optimality tolerance and will attempt to find the true optimal solution to the model. Thereafter, the solver will use the relative optimality tolerance to confine its search.

The default value for the *Time to Relative* tolerance is 100 seconds.

## Tolerances

The *Tolerances* group box contains three miscellaneous tolerances for controlling the branching strategy used by the branch-and-bound solver. The three tolerances are *Hurdle*, *Node Selection*, and *Strong Branch*. We discuss each of these in the sections that follow.

### Hurdle

Enter a value in the *Hurdle* text box if you know the objective value of a solution to a model. This value is used in the branch-and-bound manager to narrow the search for the optimum. More specifically, *What'sBest!* will only search for integer solutions in which the objective is better than the *Hurdle* value.

Any user-supplied *Hurdle* value comes into play when *What'sBest!* is searching for an initial integer solution. At this point, the solver can ignore branches in the search tree with objective values worse than the *Hurdle* value because a better solution exists (i.e., the *Hurdle*) on some alternate branch. Depending on the problem, a good *Hurdle* value can greatly reduce solution time. However, if you set a *Hurdle* value *better* than the optimal integer solution, *What'sBest!* will return an infeasible error message because no feasible answer can satisfy the bound you have set.

Once *What'sBest!* finds an initial integer solution, the *Hurdle* tolerance no longer has an effect. At this point, the relative optimality tolerance comes into play.

*Hurdle* differs from the relative optimality tolerance. If you use *Hurdle* by itself and an integer answer is found, it will yield the true optimal integer solution.

For example, if you're confident the best integer answer is at least 95 for a maximization problem, just enter 95 as the value in the *Hurdle* field. *What'sBest!* won't consider any branch that doesn't yield an answer of at least 95. If, in fact, the best integer answer is only 93, you will eventually get the message "Solution Status: No Feasible Solution Found".

The default value for *Hurdle* is *None*.

---

**Note:** When entering a hurdle value, be sure that a solution exists that is at least as good or better than your hurdle. If such a solution does not exist, *What'sBest!* will not be able to find a feasible solution to the model.

---

### Node Selection

The branch-and-bound solver has a great deal of freedom in deciding how to search the branch-and-bound solution tree. Use the *Node Selection* drop-down box to control the order in which the solver selects branch nodes in the tree.

If you examine the pull down list for the node selection option, you will see the following options:

- ◆ *Solver decides* – This is the default option. *What'sBest!* makes an educated guess regarding the best node to branch on.
- ◆ *Depth first* – *What'sBest!* spans the branch-and-bound tree using a depth first strategy.
- ◆ *Worst bound* – *What'sBest!* picks the node with the worst bound.
- ◆ *Best bound* – *What'sBest!* picks the node with the best bound.

In general, *Solver decides* will offer the best results. Experimentation with the other options may be beneficial with some classes of models.

### Strong Branch

Use the *Strong Branch* text box to specify a more intensive branching strategy during the first  $n$  levels of the branch-and-bound tree, where  $n$  is the option's setting. During these initial levels, *What'sBest!* picks a subset of the fractional variables as branching candidates. *What'sBest!* then performs a tentative branch on each of the variables in the subset, selecting as the final candidate the variable that offers the greatest improvement in the bound on the objective. Although strong branching is useful in tightening the bound quickly, it does take additional computation time. So, you may want to try different settings to determine what works best for your model.

The default *Strong Branch* setting is 10 levels.

---



### K-Best Solutions

The Desired Number parameter is used to set the number of solutions desired as part of the K-Best solutions feature of What'sBest!'s mixed integer solver. The Specify Reporting Cells is used for selecting the trade-off cells.

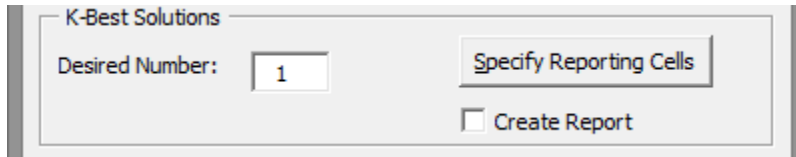

Whenever this value is greater than 1, say K, What'sBest! will return up to K unique solutions to the model, with respect to the 0/1 variables. These solutions will have the property that they are the next best solutions available in terms of their objective values. If there are K or less alternate optima in the 0/1 variables, then these solutions will be listed. Less than K solutions may be returned if a sufficient number of feasible solutions do not exist. Please refer to section Usage Guidelines for K-Best Solutions for an example of the use of the K-Best feature.

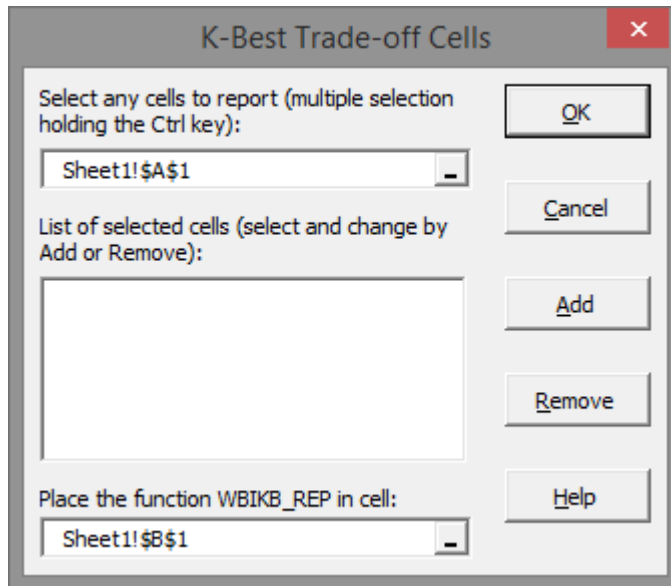

The default Desired Number is 1, with no reporting cells specified.

**Create Report Using the Function WBIKB\_REP():**

The general format is =WBIKB\_REP(cells\_to\_be\_reported), e.g. WBIKB\_REP(Sheet1!\$B\$1,Sheet1!\$B\$2), meaning the cells B1 and B2 of Sheet1 will appear in the K-Best Report. After solution, a new tab,WB!\_KBest, will be created. It will have one column for every cell to be reported, and one row for every run.

Select the checkbox to tell What'sBest! you would like a KBest report created when the model is solved. The next time you solve, What'sBest! will generate a worksheet called *WB!\_KBest* containing a listing of the cells and their values. Click on the *WB!\_KBest* tab to see the KBest report.

## Branch-and-Price Solver

The Branch-and-Price (BNP) Solver contains two parameters: Blocks and Heuristic.

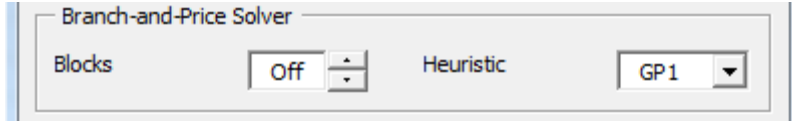

The BNP solver is a mixed integer programming solver for solving models with block structures like the following:

Minimize:  $\sum c(k) * x(k)$

Subject To:

$\sum A(k) * x(k) = d$  (linking constraints)

$x(k)$  in  $X(k)$ , for all  $k$  (decomposition structure)

where  $d$ ,  $c(k)$  and  $x(k)$  are vectors and  $A(k)$  is a matrix with appropriate dimensions.  $x(k)$  contains decision variables and  $X(k)$  denotes a linear feasible domain for  $x(k)$ .

The BNP solver is a hybrid of branch-and-bound, column generation, and Lagrangean relaxation methods. It can help to find either the optimal solution or a better lower bound (the Lagrangean bound) for a minimization problem. Based on the decomposition structure, the solver divides the original problem into several subproblems, or blocks, and solves them (almost) independently, exploiting parallel processing if multiple cores are available.

BNP may perform better than the default MIP solver if: a) the number of linking constraints is small, b) the number of blocks is large and they are of approximately the same size, and c) the number of available processors (or cores) is large, e.g., 4 or more. Also, there may be some models for which BNP finds a good solution and good bound more quickly than the default MIP algorithm, although it may take longer to prove optimality.

The Blocks option for the BNP solver controls the number of subproblems, or blocks, that the model will be partitioned into. Possible setting for the Blocks parameter are:

- ◆ Off - This will disable the BNP solver, in which case, the standard MIP solver will be used to solve all mixed integer linear programs.
- ◆ N - A positive integer, greater-than-or-equal-to 2, indicating the number of independent blocks to try and partition the model into via one of the graph partitioning algorithms provided by *What'sBest!*. The actual heuristic used is chosen with the Heuristic parameter.

The default setting for Blocks is Off, i.e., the BNP solver will not be used on integer programming models.

The Block Heuristic parameter controls the heuristic used to partition the model into blocks. You may currently select from two graph partitioning algorithms named simply GP1 and GP2, with the default setting being GP1.

## Usage Guidelines for K-Best Solutions

As an example, you are packing a basket for a picnic you will be taking with a friend. You've constructed a list of items you would like to carry with you on the picnic. Each item has a weight associated with it and your knapsack is limited to carrying no more than 15 pounds. You have also come up with a 1 to 10 rating for each item, which indicates how strongly your friend wants to include the particular item in the knapsack for the picnic. The information are listed in the model below, "KNAPSACK\_KBEST.xlsx".

The *KNAPSACK\_KBEST* Worksheet *Before Solving*

	Weight	Rating	Include	
Brats	3	1	0	WBIKB_REP
Brownies	3	1	0	
Beer	3	1	0	
Ant Repel	7	1	0	
Blanket	4	6	0	
Frisbee	1	6	0	
Salad	5	10	0	
Watermelon	7	9	0	
				Knapsack Capacity
			0	<= 15
Favorites in Knapsack			0	
This model uses the K-Best feature via the Integer Solver.				

Where:

Cell F12 has the formula: =SUMPRODUCT(C3:C10,WBBINf), where WBBINf is the range for the adjustable binary cells in column F.

Cell E13 has the formula: =SUMPRODUCT(D3:D10,F3:F10), objective cell to maximize.

Cell G12 is the capacity constraint: =WB(F12,"<=",H12).

Say our friend's ratings of the candidate picnic items is given in the data section above, and the rating is different than yours:

Brats	8
Brownies	10
Beer	9
Ant Repel	2
Blanket	3
Frisbee	6
Salad	4
Watermelon	10

## 84 CHAPTER 3

If we solve the model as is, thus solely maximizing our preferences, we get the following solution:

The *KNAPSACK\_KBEST* Worksheet *After* Solving

The screenshot shows an Excel spreadsheet titled "Knapsack\_KBest.xlsx" with the following data:

	A	B	C	D	E	F	G	H	I	J
1										
2			Weight	Rating		Include				
3		Brats	3	1		0		WBIKB_REP		
4		Brownies	3	1		0				
5		Beer	3	1		0				
6		Ant Repel	7	1		0				
7		Blanket	4	6		0				
8		Frisbee	1	6		1				
9		Salad	5	10		1				
10		Watermelon	7	9		1				
11								Knapsack Capacity		
12						13	<=	15		
13			Favorites in Knapsack			25				
14										
15										
16										
17										
18										

At the bottom of the spreadsheet, there is a text box containing the message: "This model uses the K-Best feature via the Integer Solver."

The status bar at the bottom of the Excel window shows "READY", "Knapsack", and "100%" zoom.

As indicated by the adjustable cells, a few of our favorite items are included in the optimal basket. However, we are wondering if there isn't another combination of items that our friend might like almost as much that includes most of our favorite items.

To investigate this question, we set the Desired Number parameter of the K-Best Solutions box to 5, via the *Options...|Integer Solver*.

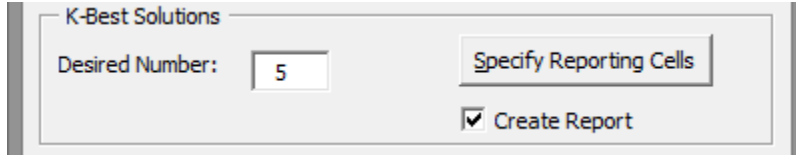

We also define the cells to look at via the button **Specify Reporting Cells**, here all the Adjustable cells: select the range of cells, or cell by cell, select the cell to refer, then click **Add**. You can modify or delete an entry by clicking on the cell reference in the list.

Cell H3 has the formula: =WBIKB\_REP(F3:F10)

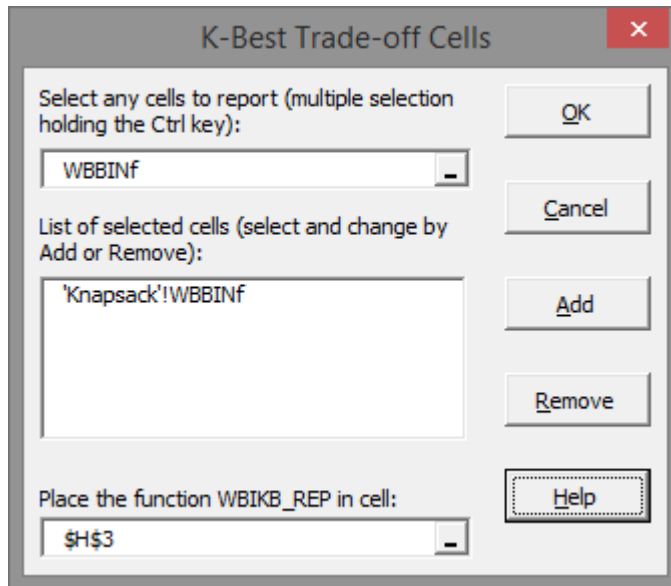

This means that we would like to generate the 5 best solutions to the model. We then click **OK** and then run the Solve command. The solver sees that the K-Best feature is being requested, and it automatically generates the 5 best solutions to the model. At which point, we are presented with the following dialog box:

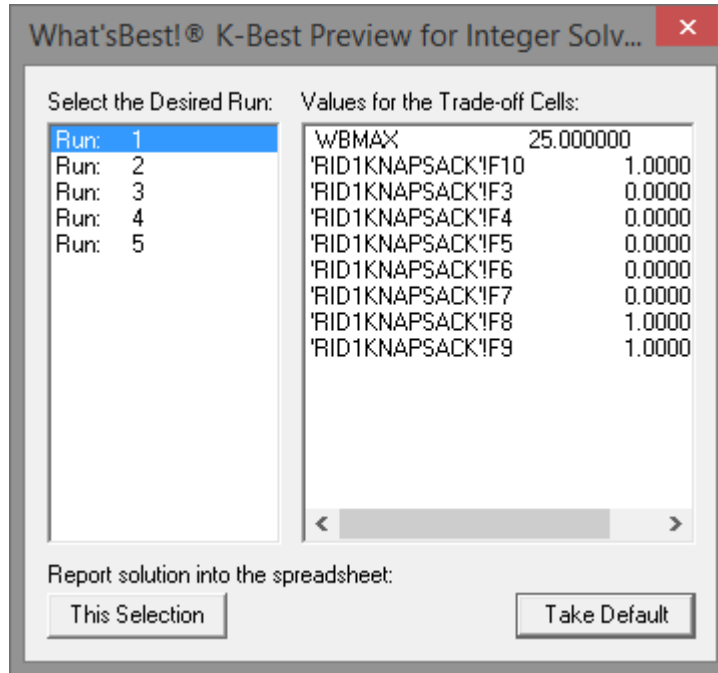

In the Preview window, we see that the solver was able to find 5 feasible next-best solutions to the model. The solutions are ranked in order by their objective values.

There is also a column labeled Trade-off Cells, which lists the value in each solution of a designated trade-off variable. Any scalar variable in a model can be selected as the tradeoff variable. In this example, there are 9 variables, and the objective cell WBMAX is automatically selected as a tradeoff variable. The idea behind the trade-off variable is that it allows you to weigh the trade-offs in a model's objective value with a secondary goal. In this case, our secondary goal is the number of our favorite items in the picnic basket. In particular, we see that there are three solutions with slightly worse objective values (23 vs. 25) that include one of our favorite items.

For example, if we selected the solution "Run: 2" and pressed the **This Selection** button, we'd see the following solution containing one of our favorite items, Brownies (cell F4). The **Take Default** button selects the "Run: 1", which is the solution of the objective cell.

These buttons allow you to display selected solutions returned by the K-Best solver. Once a final solution is selected, all subsequent status and solution reports will be based on that particular solution.

Here's an example of the K-Best report for the KNAPSACK\_KBEST sample model, when the option was selected before solving.



The screenshot shows an Excel spreadsheet titled "Knapsack\_KBest.xlsx". The active sheet is "WB!\_KBest". The spreadsheet content is as follows:

	A	B	C	D	E	F
1	What'sBest!® 13.0.0.0 (Sep 30, 2014) - Lib. 9.0.1889.103 - 64-bit					
2						
3	DATE GENERATED:	Oct 14, 2014	09:34 AM			
4						
5						
6		REPORTING CELLS				
7	Run					
8		Knapsack!E13	Knapsack!F3	Knapsack!F4	Knapsack!F5	Knapsack!F6
9	-----					
10	- 1-	25	0	0	0	
11	- 2-	23	0	1	0	
12	- 3-	23	1	0	0	
13	- 4-	23	0	0	1	
14	- 5-	22	0	0	0	
15						
16						

The status bar at the bottom indicates "READY" and "90%" zoom.

## ***Options...| Stochastic Solver***

The *Options...|Stochastic Solver* command allows you to support Stochastic Modeling via the series of dialog boxes.

**Note:** The user can directly enter or modify the stochastic functions in the spreadsheet without reopening the dialog box.

### ***Stochastic Modeling Support***

By checking this option, the model will be processed as a stochastic model. Otherwise, *What'sBest!* will treat the core model, even if some stochastic functions are set in the spreadsheet.

The default setting is False (unchecked).

---

Page Step 1 "core model"

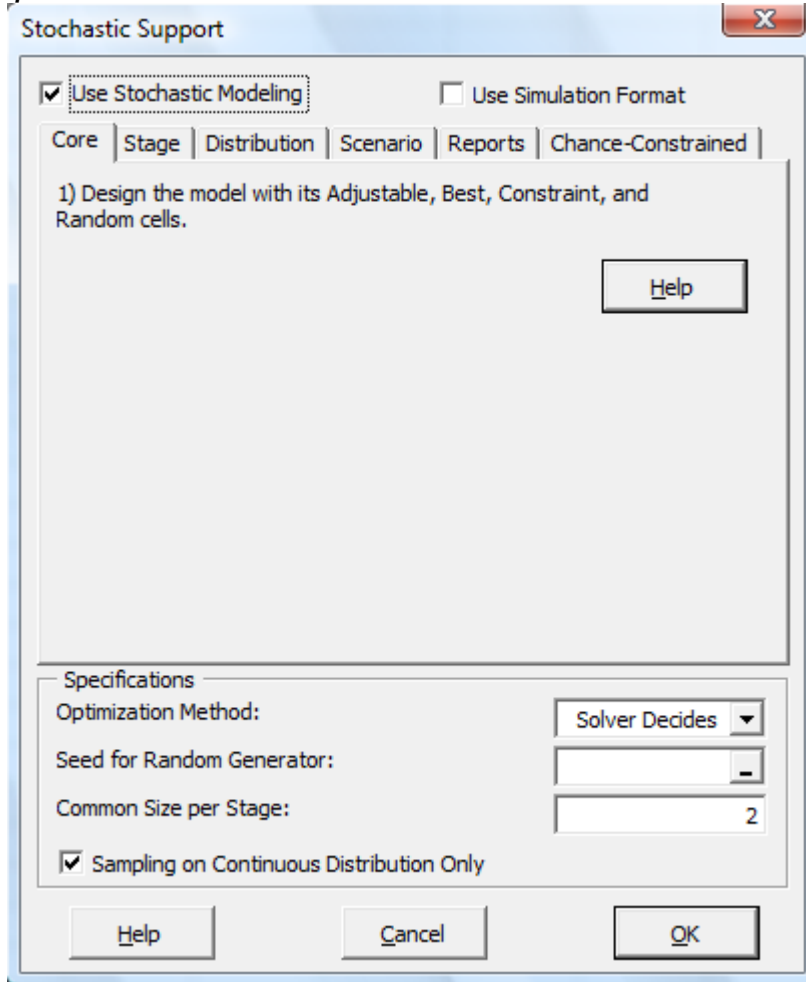

This step simply reminds you to first formulate a standard deterministic “core” model (Adjustable, Best, Constraint). A cell that represents a Random quantity is simply filled with an arbitrary number.

Cells containing equations or strings are inappropriate as random cells. What'sBest! cannot rewrite an equation, although the value returned by an equation will change, if the equation depends upon any adjustable cells. Therefore, be sure to enter a numeric value in each of your random cells.

---

**Note:** The Random cells will be identified during the Step 2 below.

---

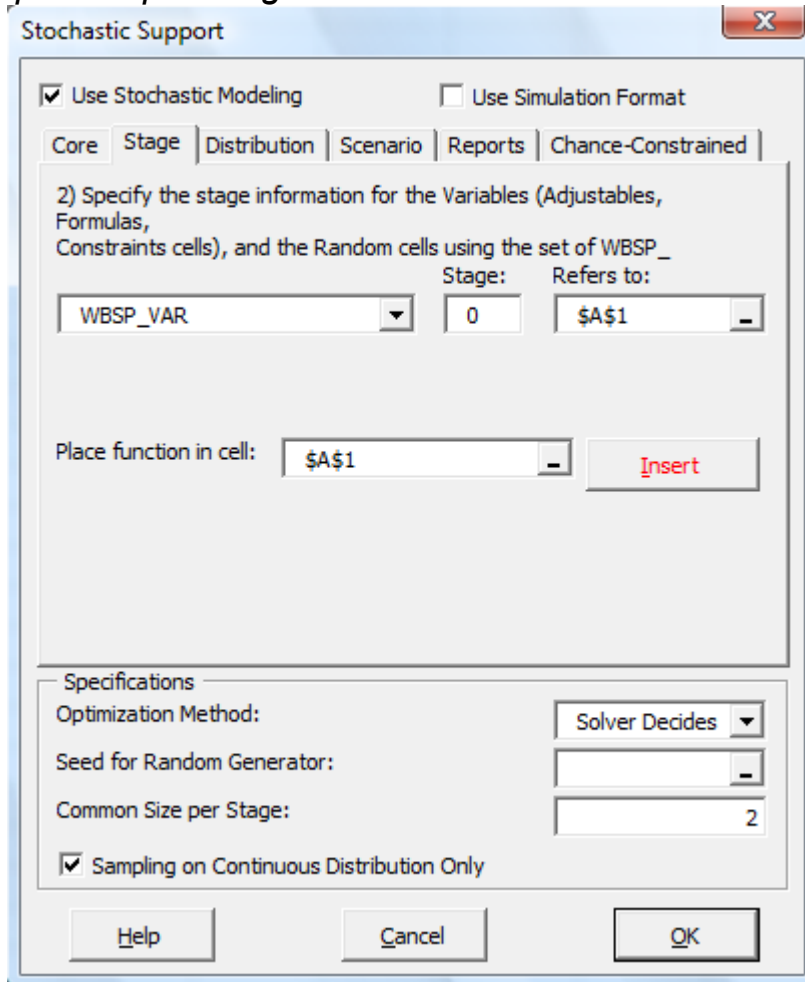
*Page Step 2 "sequencing"*

This step provides the related pieces of the sequencing of decision and random events, or “staging”.

The general sequence of events is as follows: Stage 0: We make initial decisions; Stage 1, beginning: First set of random variables are observed, Stage 1, end: We make additional decision or calculations based on observations so far, Stage 2, beginning, the second set of random variables are observed, etc.. This staging information is inserted into the sheet with the WBSP\_VAR and WBSP\_RAND functions as follows.

In the drop-down list, you can select a WBSP\_ function with its associated arguments.

**Variables:**

"WBSP\_VAR"

Use this function to associate a Stage to an Adjustable, Constraint, or formula cell.

The format is =WBSP\_VAR(*stage,cells\_with\_this\_stage*), e.g., =WBSP\_VAR(0,Sheet1!\$A\$2) means cell A2 in Sheet1 is in Stage 0. The entry "Place function in cell:" allows you to place this information in a any cell in the workbook. Typically you place this information near the decision cell so that you can quickly observe the staging information of a cell without calling up any special menus.

**Randoms:**

"WBSP\_RAND"

Use this function to associate a Stage to a Random cell.

The format is =WBSP\_RAND(*stage,random\_cells\_with\_this\_stage*), e.g., =WBSP\_RAND(1,Sheet1!\$A\$2), meaning cell A2 in Sheet1 will be at Stage 1.

The "NONE" choice will actually delete the selected cell.

**Refers To:**

Specify the random cell on which to apply the distribution. Alternately, you can accept the currently selected cells, which *What'sBest!* has automatically placed in this box. You can also type the correct cell range directly into the text box.

**Place function in cell:**

Specify the cell in which to write the WBSP\_ function. Alternately, you can accept the currently selected cells, which *What'sBest!* has automatically placed in this box. You can also type the correct cell range directly into the text box.

---

## Page Step 3 "distributions or correlations"

Stochastic Support

Use Stochastic Modeling       Use Simulation Format

Core | Stage | Distribution | Scenario | Reports | Chance-Constrained

3) Specify the associated distributions or correlations using the set of WBSP\_ functions.

WBSP\_DIST\_DISCRETE\_SH      Refers to: \$A\$1

Discrete values: \$A\$1

Place function in cell: \$A\$1      **Insert**

Specifications

Optimization Method: Solver Decides

Seed for Random Generator:

Common Size per Stage: 2

Sampling on Continuous Distribution Only

Help      Cancel      OK

This step provides the distributions of the random variables, so to specify the distribution information about the random cells.

The format is `=WBSP_DIST_distribution(parameter_cells,random_cells)`, e.g., `=WBSP_DIST_LOGNORMAL(C2,D2,Sheet1!$A$2)`, meaning the random cell A2 in Sheet1 will follow a Lognormal distribution with the value in C2 for the Mean (argument 1), and the value in D2 for the Standard Deviation sigma (argument 2). As before, the entry "Place function in cell:" allows you to place this information in a any cell in the workbook. Typically you place this information near the random cell(s) so that you can quickly observe the distribution information of a cell without calling up any special menus.

Distributions with one argument:

- "WBSP\_DIST\_DISCRETE\_SH" argument 1: Discrete values, with scenarios read horizontally
- "WBSP\_DIST\_DISCRETE\_SV" argument 1: Discrete values, with scenarios read vertically
- "WBSP\_DIST\_CHISQUARE" argument 1: Degrees freedom
- "WBSP\_DIST\_EXPONENTIAL" argument 1: Rate
- "WBSP\_DIST\_GEOMETRIC" argument 1: Success probabilities
- "WBSP\_DIST\_LOGARITHMIC" argument 1: p-Factor
- "WBSP\_DIST\_POISSON" argument 1: Mean
- "WBSP\_DIST\_STUDENTS\_T" argument 1: Degrees freedom

Distributions with two arguments:

- "WBSP\_DIST\_DISCRETE\_SH\_W" argument 1: Discrete values, argument 2: Weight probabilities, with scenarios read horizontally
- "WBSP\_DIST\_DISCRETE\_SV\_W" argument 1: Discrete values, argument 2: Weight probabilities, with scenarios read vertically
- "WBSP\_DIST\_BETA" argument 1: Shape 1, argument 2: Shape 2
- "WBSP\_DIST\_BINOMIAL" argument 1: Sample size, argument 2: Success probabilities
- "WBSP\_DIST\_CAUCHY" argument 1: Location, argument 2: Scale
- "WBSP\_DIST\_GAMMA" argument 1: Shape, argument 2: Scale
- "WBSP\_DIST\_GUMBEL" argument 1: Location, argument 2: Scale
- "WBSP\_DIST\_F\_DISTRIBUTION" argument 1: Degrees freedom 1, argument 2: Degrees freedom 2
- "WBSP\_DIST\_LAPLACE" argument 1: Location, argument 2: Scale
- "WBSP\_DIST\_LOGISTIC" argument 1: Location, argument 2: Scale
- "WBSP\_DIST\_LOGNORMAL" argument 1: Mean, argument 2: Sigma
- "WBSP\_DIST\_NEGATIVEBINOMIAL" argument 1: r-Factor, argument 2: Success probabilities
- "WBSP\_DIST\_NORMAL" argument 1: Mean, argument 2: Sigma
- "WBSP\_DIST\_PARETO" argument 1: Scale, argument 2: Shape
- "WBSP\_DIST\_SYMMETRICSTABLE" argument 1: Alpha, argument 2: Success probabilities
- "WBSP\_DIST\_UNIFORM" argument 1: Upper limit, argument 2: Upper limit
- "WBSP\_DIST\_WEIBULL" argument 1: Scale, argument 2: Shape

**Distributions with 3 arguments:**

"WBSP\_DIST\_HYPERGEOMETRIC"      argument 1: Population, argument 2: Defective, argument 3: Size

"WBSP\_DIST\_TRIANGULAR"      argument : Lower, argument 2: Upper, argument 3: Mode

**Correlations:**

You can also specify the correlation information about the random cells. Correlation is optional.

The format is =WBSP\_CORR\_correlation(matrix,random\_cells), e.g., =WBSP\_CORR\_SPEARMAN(M19:N20,Sheet1!\$B\$13:\$B\$14), meaning the random cells B13 and B14 in Sheet1 will follow a spearman correlation with the matrix defined in the range M19:N20. This is a 2-column and 2-row matrix for the 2 random cells to correlate. As before, the entry "Place function in cell:" allows you to place this information in a any cell in the workbook. Typically you place this information near the random cell(s) so that you can quickly observe the correlation information of a cell without calling up any special menus.

"WBSP\_CORR\_KENDALL"      argument 1: matrix

"WBSP\_CORR\_PEARSON"      argument 1: matrix

"WBSP\_CORR\_SPEARMAN"      argument 1: matrix

The "NONE" choice will actually delete the selected cell.

---



**Refers To:**

Specify the random cell on which to apply the distribution. Alternately, you can accept the currently selected cells, which What'sBest! has automatically placed in this box. You can also type the correct cell range directly into the text box.

**Place function in cell:**

Specify the cell in which to write the W BSP\_ function. Alternately, you can accept the currently selected cells, which What'sBest! has automatically placed in this box. You can also type the correct cell range directly into the text box.

*Page Step 4 "scenario sampling"*

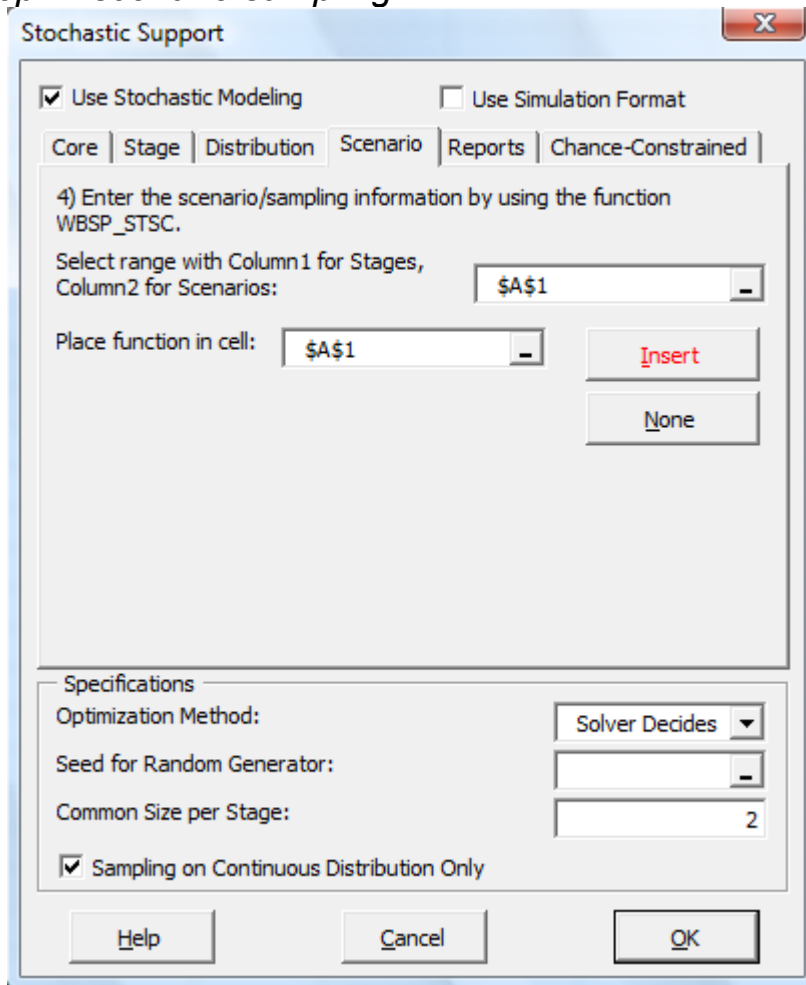

This command allows you to specify the Scenario/Sampling information for the stochastic part.

The general format is =WBSP\_STSC(*stages and sample sizes*), e.g. WBSP\_STC(B1:C3), means range B1:B3 lists the Stages, and range C1:C3 lists sample size for each stage.

Sampling with WBSP\_STSC() has to be specified if the model contains a continuous distribution. With a discrete distribution, there is no necessary call for sampling because it takes the discrete values directly from the discrete table. Otherwise sampling will be applied on the discrete distribution too.

In case of a model with both distributions, continuous and discrete, so the user may want to apply sampling only on the continuous, with the option "Sampling on Continuous Distribution Only" via the Stochastic Solver options box.

**Select Range:**

Select the a two-column range, where the column1 is for the Stage in ascending order, and the second column for the number of scenarios associated to the stage.

**Place function in cell:**

Specify the cell in which to write the "WBSP\_STSC" function.

**Set button:**

Place the function in the spreadsheet.

**None button:**

Delete the selected cell.

---

## Page Reports

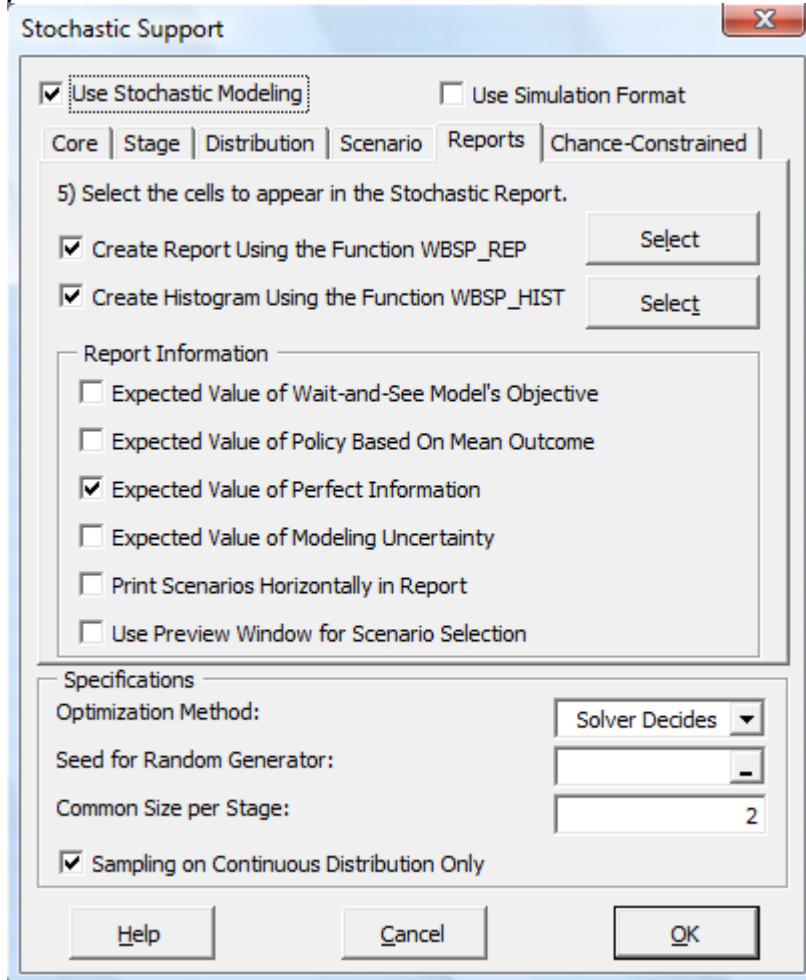

The solution of an SP model can produce a lot of information. You are probably interested in only a small portion of these results. These features allow you to specify the cells for which to report the values in the *WB!\_Stochastic* and the *WB!\_Histogram* sheets.

### Create Report Using the Function WBSP\_REP():

The general format is =WBSP\_REP(*cells\_to\_be\_reported*), e.g. WBSP\_REP(Sheet1!\$B\$1,Sheet1!\$B\$2), meaning the cells B1 and B2 of Sheet1 will appear in the *Stochastic Scenario Report*. After solution, a new tab, *WB!\_Stochastic*, will be created. It will have one column for every cell to be reported, and one row for every scenario.

Select the checkbox to tell *What'sBest!* you would like a stochastic report created when the model is solved. The next time you solve, *What'sBest!* will generate a worksheet called *WB! Stochastic* containing a listing of the cells and their locations, and values of the variables solution or the random outcomes for the scenario path. Click on the *WB! Stochastic* tab to see the stochastic report.

### Select button:

This button will open a new window.

To create the list of reporting cells, specify the cell or cell range in the *Select any cell to report:* field. Once this is done, pressing the *Add* button causes the selected cells to appear in the *List of selected cells* box. You can decide to remove any selected cells by simply going to the list box, select the cell reference to remove from the list of names, and click on the *Remove* button.

The "WBSP\_REP" function will be placed in the current selection of the field *Place the function WBSP\_REP in cell:*

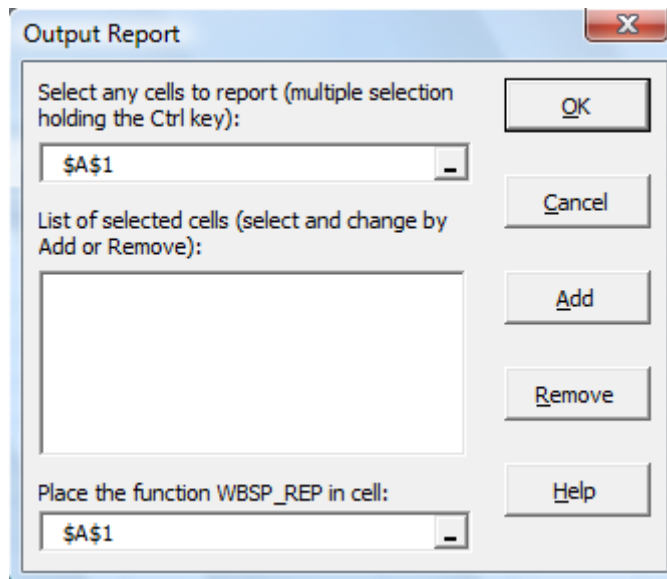

Here's an example of the stochastic report for the SP\_NEWSVENDOR sample model:

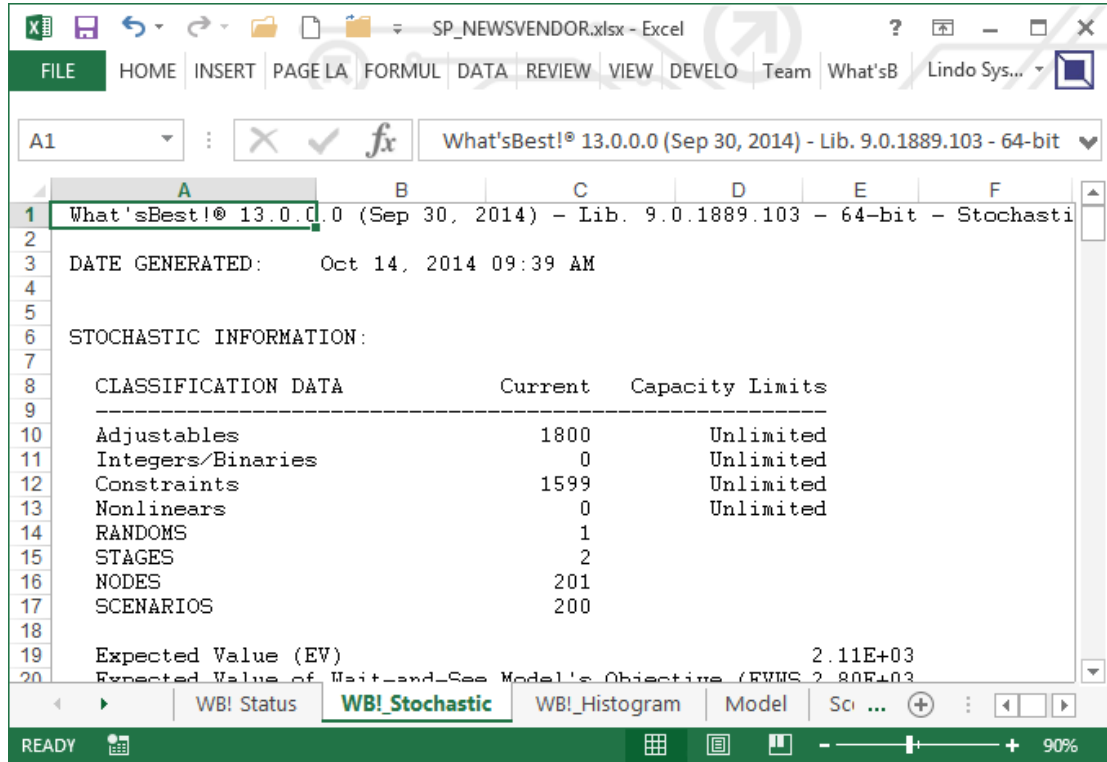

Once created, the *WB! Stochastic* report will stay on the workbook, and the solver will just clear the sheet during successive runs. This makes possible for other sheets to keep their cells reference from this report for displaying a specific data.

### Create Histogram Using the Function WBSP\_HIST():

The general format is =W BSP\_HIST(number\_of\_bins,cells\_to\_be\_reported), e.g. WBSP\_HIST(0,Sheet1!\$B\$1), meaning the solver decides of the number of bins, and cell B1 Sheet1 will appear in the Stochastic Histogram Report. After solution, a new tab, WB!\_Histogram, will be created. It will have four columns reporting the Bin Lows, Bin Highs, Mid-Points, and Bin Counts.

Select the checkbox to tell What'sBest! you would like a stochastic histogram created when the model is solved. The next time you solve, What'sBest! will generate a worksheet called WB!\_Histogram containing a listing of the data, and the histogram graph for the Bin Counts against the Mid-Points values. Click on the WB!\_Histogram tab to see the stochastic histogram report.

### Select button:

This button will open a new window.

To create the list of reporting cells, specify the cell or cell range in the Select any cell to report: field, and the number of bins. Once this is done, pressing the Add button causes the selected cells to appear in the List of selected cells box. You can decide to remove any selected cells by simply going to the list box, select the cell reference to remove from the list of names, and click on the Remove button.

The "W BSP\_HIST" function will be placed in the current selection of the field *Place the function W BSP\_HIST in cell:*

**Histogram Chart**

Create the histogram for any cells, displaying the number of bins and the mid-points, using the function W BSP\_HIST().

Number of bins:

Select any cells to report (multiple selection holding the Ctrl key):

List of selected cells (select and change by Add or Remove):

Place the function W BSP\_HIST in cell:

Buttons: OK, Cancel, Add, Remove, Help

Here's an example of the histogram report for the SP\_NEWSVENDOR sample model:

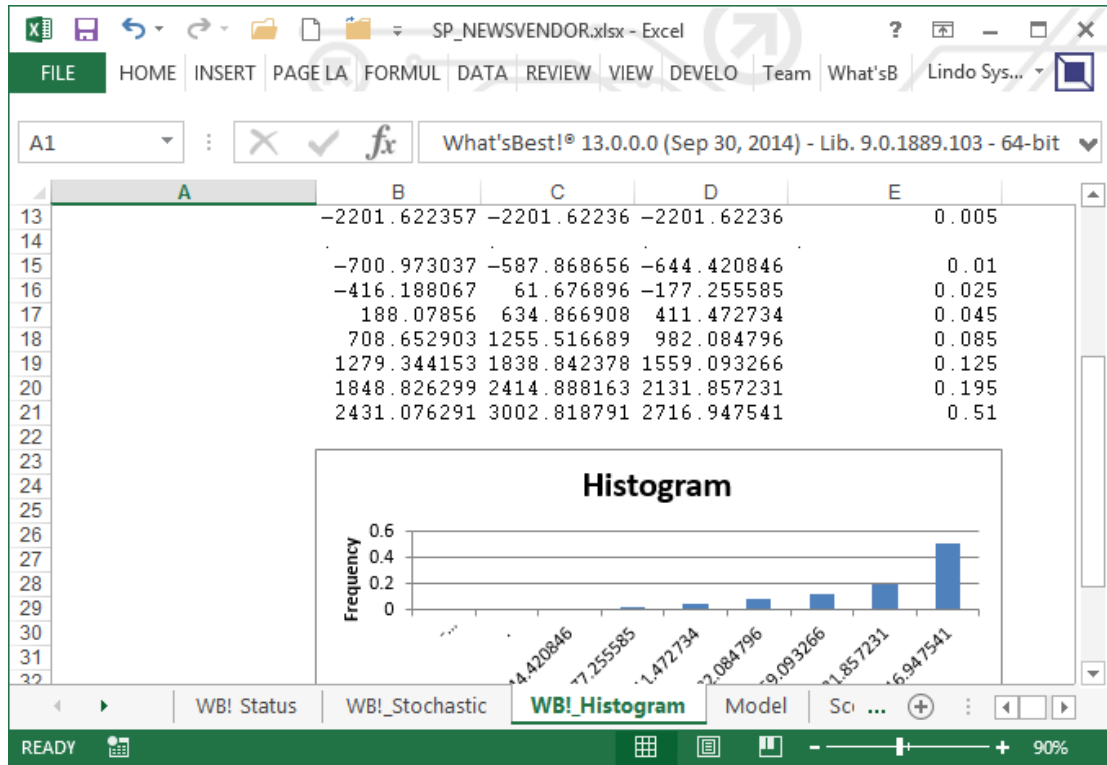

Once created, the *WB! Histogram* report will stay on the workbook, and the solver will just clear the sheet during successive runs. This makes possible for other sheets to keep their cells reference from this report for displaying a specific data.

The solver writes a series of solution in the created tab '*WB! Stochastic*', and '*WB! Histogram*', with the expected value, and displays the first default scenario, or a selected scenario, on the spreadsheet.

Please refer to the section *Guidelines for Stochastic Modeling* for a tutorial and information on how to use Stochastic Support effectively.

### Expected Value of Objective

The *Expected Value of Objective (EV)* is the expected value for the model's objective over all the scenarios, and is the same as the reported objective value for the model.

This value is provided by default in the report.

The user can directly request the value on the spreadsheet, by inserting the function in a cell =*WBSP\_MEAN(cellref, value)*. The cell will display the mean value requested for the *cellref*.

For instance, enter =*WBSP\_MEAN(\$B\$22, 0)* in any cell. After solving, this function will display the mean value of 2106.49622433202 for the objective cell in B22.

### Calculation for Expected Value of Wait-and-See Model's Objective

The Expected Value of Wait-and-See Model's Objective (EVWS) reports the expected value of the objective if we could wait and see the outcomes of all the random variables before making our decisions. Such a policy would allow us to always make the best decision based on the outcomes for the random variables, and, of course, is not possible in practice. For a minimization, it's true that  $EVWS \leq EV$ , with the converse holding for a maximization. Technically speaking, EVWS is a relaxation of the true Stochastic Programming model, obtained by dropping the nonanticipativity constraints. Possible flag values are Disable (False), or Enable (True).

The default setting is off, the EVWS is not calculated.

### Calculation for Expected Value of Policy Based On Mean Outcome

This Expected Value of Policy Based On Mean Outcome (EVEM) is the expected true objective value if we (mistakenly) assume that all random variables will always take on exactly their mean values. EVEM is computed using a two-step process. First, the values of all random variables are fixed at their means, and the resulting deterministic model is solved to yield the optimal values for the stage 0 decision variables. Next, a) the stage 0 variables are fixed at their optimal values from the previous step, b) the random variables are freed up, c) the nonanticipativity constraints are dropped, and d) this wait-and-see model is solved. EVEM is the objective value from this EVWS model. Possible flag values are Disable (False), or Enable (True).

The default setting is off, the EVEM is not calculated.

### Calculation for Expected Value of Perfect Information

This Expected Value of Perfect Information (EVPI) is the absolute value of the difference between EV and EVWS. This corresponds to the expected improvement to the objective were we to obtain perfect information about the random outcomes. As such, this is a expected measure of how much we should be willing to pay to obtain perfect information regarding the outcomes of the random variables. Possible flag values are Disable (False), or Enable (True).

The default setting is to enable calculation.

---



---

### Calculation for Expected Value of Modeling Uncertainty

This Expected Value of Modeling Uncertainty (EVMU) is the absolute value of the difference  $EV - EVEM$ . It is a measure of what we can expect to gain by taking into account uncertainty in our modeling analysis, as opposed to mistakenly assuming that random variables always take on their mean outcomes. Possible flag values are Disable (False), or Enable (True).

The default setting is off, the EVMU is not calculated.

---

**Note:** The above approach for computing EM and EVMU makes unambiguous sense only for models with a stage 0 and a stage 1. If there are later random variables in stages 2, 3, etc., then there are complications. For example, for decisions in later stages, we have seen the outcomes from the random variables in earlier stages, so considering these random variables to take on their mean value does not make sense. For models with additional stages beyond 0 and 1, EVMU will merely be an approximation of the true expected value of modeling uncertainty.

---

---

**Note:** Computing these expected value statistics can be very time consuming for large models.

---

### Print Scenarios Horizontally in Report

This flag enables to print the scenarios along a row in the `WB!_Stochastic` report, so the reporting cells will be displayed along a column. It is useful for models reporting numerous cells for a few scenarios.

The default setting is off, meaning the scenarios will appear vertically in the report.

### Use Preview Window for Scenario Selection

Once the solver has completed the stochastic calculation, the user can have a preview of the cells to report by selecting the scenario number. By default, the solution values of the scenario 1 will be written back into the spreadsheet, but another scenario solution can be selected. This will allow a closer look of a particular scenario when reading the spreadsheet.

The cells are selected via the same `WBSP_REP()` function, for either an Adjustable, Variable, Number, Constraint, Random Parameter, or any Dual references. All the scenarios will be anyway written in the `WB!_Stochastic` sheet, is this report was previously requested.

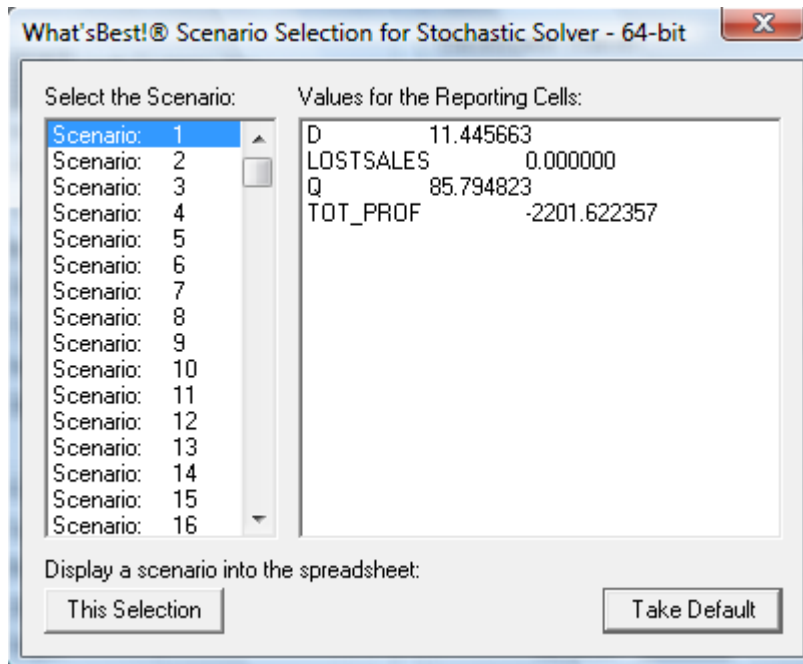

## Page Chance-Constrained

The screenshot shows the 'Stochastic Support' dialog box with the 'Chance-Constrained' tab selected. The 'Use Stochastic Modeling' checkbox is checked, and 'Use Simulation Format' is unchecked. The 'Core' tab is active, showing instructions to specify a range for Chance-Constrained using 'WBSP\_CC\_LT' or 'WBSP\_CC\_GT'. The 'WBSP\_CC\_LT' dropdown is selected. The 'Percent' is set to 1, and the 'Objective weight' is set to 1. Both 'Refers to' and 'Place function in cell' are set to '\$A\$1'. An 'Insert' button is visible next to the 'Place function in cell' field. The 'Specifications' section shows 'Optimization Method' set to 'Solver Decides', 'Seed for Random Generator' is empty, and 'Common Size per Stage' is set to 2. The 'Sampling on Continuous Distribution Only' checkbox is checked. At the bottom are 'Help', 'Cancel', and 'OK' buttons.

This page is useful to setup a stochastic model in Chance-Constrained format, which is the second major class of models in stochastic programming. The goal in Chance-Constrained Programming is to make an optimal decision prior to realization of random data, while controlling the chance that constraints are violated in one stage.

Extensive explanation on Chance-Constrained Programming are given in the *Guidelines for Chance-Constrained Modeling*.

**Specify Chance-Constrained Using the Function WBSP\_CC\_LT() or WBSP\_CC\_GT():**

The general format is =WBSP\_CC\_LT(*percent, weight, constraint cells*), where LT for "Lower Than", or =WBSP\_CC\_GT(*percent, weight, constraint cells*) with GT for "Greater Than".

**Percent:**

This is the amount by which the constraints assigned to this set must be satisfied in the scenarios. Otherwise, the scenario will be considered as unsatisfied, according to the direction function.

**Objective Weight:**

The amount by which to give priority to the objective value.

**Refers To:**

Specify the constraint cells on which to apply the Chance-Constrained feature. You can select multiple ranges in the same function which will be treated as being in the same set. Otherwise, specifying different functions, the solver will treat the Chance-Constrained functions as different sets. The reference ranges are entered into the text box.

**Place function in cell:**

Specify the cell in which to write the WBSP\_ function. The reference ranges have to be entered into the text box.

### ***Frame Specifications***

The Stochastic Solver option allows you to solve models in which some cells are random variables. The frame posted by the Options...|Stochastic Solver command appears as follows:

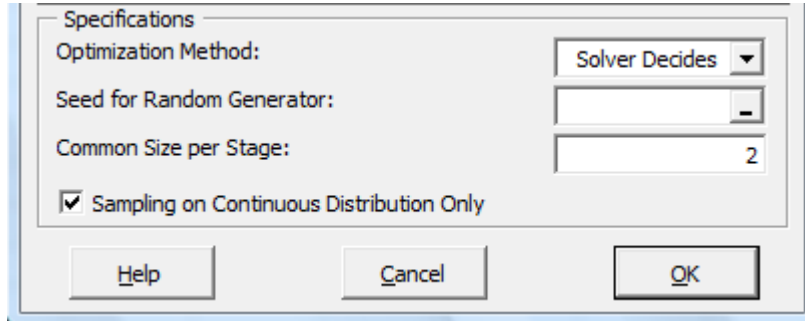

**Optimization Method:**

Indicates the method you would like the stochastic solver in *What'sBest!* to employ using the Optimization Method drop-down box. Possible choices include: Solver Decides, Free, Deterministic Equivalent, Nested Benders Decomposition, Augmented Lagrangian Decomposition, and Simple Benders Decomposition. The Solver Decides setting currently defaults to the free method.

The default setting for Solver Method is Solver Decides.

**Seed for Random Generator:**

This is the Seed to initialize the random number generator. Possible values are positive integers, and can be set via a single cell reference, or a number.

The default setting for Seed is 1031.

**Common Size per Stage:**

This is the default number of scenarios to generate per stage. Possible values are positive integers.

The logical states will behave as follow:

	"Sampling on Continuous Only" Checked	"Sampling on Continuous Only" Not Checked
<b>Function =WBSP_STSC() Not Defined</b>	Use of Common Size per Stage for Continuous, and the Defined Table Size for Discrete Distributions	Use of Common Size per Stage
<b>Function =WBSP_STSC() Defined</b>	Use of Function Argument for Continuous, and the Defined Table Size for Discrete Distributions	Use of Function Argument

The default setting for Common Sample Size is 2.

**Sampling on Continuous Distribution Only**

In case of a model with both distributions, continuous and discrete, this flag enables the sampling technique only on the continuous distribution, leaving the discrete distribution with its own set of data. Sampling can be applied with the spreadsheet function WBSP\_STSC().

The default setting is on; meaning sampling is applied on continuous distributions.

## *Use Simulation Format*

By checking this option, the model will be processed for simulation. Based on a stochastic model, the user can set up the random parameters and their associated distributions at a stage 0, eventually any additional formulation, and What'sBest! will calculate the values of the reporting cells. There is no need of defining an adjustable, constraint, or objective cells. This feature will be useful for knowing the behavior of some cells along the scenarios, and to display their histograms.

The default setting is False (unchecked).

---

## Options...|Reset to Default

This command resets all workbook options to their default values. Such options can be seen in the *Insert|Name|Define...* or *Name Manager* menu as *WBxxx* names. This command does not restore options defined in the *Advanced Parameter* window to default values. See the section entitled *Options and Solvers* for more information about workbook options.

Upon first use, the *Reset to Default* command displays the following dialog box:

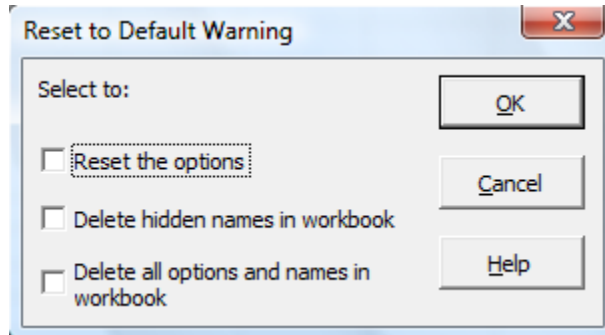

"Reset the options" will remove the *WBxxx* names in the workbook. These names belong to *What'sBest!* and were created via the *Options* dialog boxes.

"Deleting hidden names" will only remove names in the workbook that are not visible or listed via the *Name Manager* of Excel®.

"Deleting all names and options" will actually remove any names from the workbook.

These names could have been defined by *What'sBest!*, the user, Excel®, or other applications saving names in this workbook file. Removing these visible or invisible names will clean up the file, and the user has to redefine the useful names.

## Advanced...|Dual...

The dialog box posted by the *Advanced...|Dual* command appears as follows:

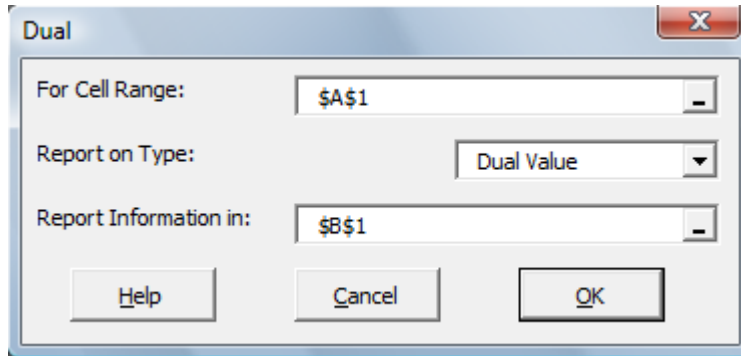

The *Dual* command allows for reporting of dual values for the chosen cells or range of cells. If you are requesting dual values for a range of cells, then the range in *Report Information in:* should be identical in dimension to the range in *For Cell Range:*.

*What'sBest!* provides three dual value options in the *Report on Type* box. The first, *Dual Value*, lets you define the dual value of a cell or range of cells. The formula will be  $=WBDUAL(\text{cell}, \text{number})$ . The other two, *Upper Range* and *Lower Range*, let you define the upper and lower ranges for dual values. The formulas are  $=WBUPPER(\text{cell}, \text{number})$  and  $=WBLOWER(\text{cell}, \text{number})$ . The study of these values and their effect on the solution of the model is called sensitivity analysis. Please refer to the section *Usage Guidelines for Dual Values* for a tutorial and information on how to use this option effectively.



## *For Cell Range*

This is the target range of cells you wish dual reporting on. *What'sBest!* will automatically fill this box with the cells directly to the left of the current selection of cells, or above them if the entire row is selected. If this is not the range of cells you want, you can type the correct range in or select the button on the right edge of the text box to bring up a cursor for cell selection.

## *Report on Type*

### Dual Value

Select *Dual Value* to prompt *What'sBest!* to return the dual value of the adjustable or constraint cells specified in *For Cell Range*:

To enter a dual value function, put the cursor in the cell for which you want to find the dual value and select *Dual Value*. Then, specify the cell in which you want the dual information displayed in the *Report Information in:* box.

**Note:** When taking the dual value of a constraint, be sure to specify the cell containing the constraint *function*, not the right-hand side of the constraint.

### Upper Range and Lower Range

Select *Upper Range* or *Lower Range* to cause *What'sBest!* to return the upper and lower valid ranges for a dual value. That is, the upper and lower bounds of the range over which the dual value of a constraint or adjustable cell stays the same.

**Note:** Calculating upper and lower ranges may significantly increase solution times, so it is good to weigh the benefits of the additional information against the amount of extra time it will take to get that information. This runtime consideration is particularly relevant for large models.

## *Report Information in*

Specify the host range of cells you would like to see the dual information placed in the *Report Information in* text box. *What'sBest!* will automatically fill this box with the current selection of cells.

---

## Usage Guidelines for Dual Values

Dual values can provide valuable sensitivity information. They can give you a feel for how sensitive a solution is to a particular constraint cell or adjustable cell. What'sBest! can provide dual information on any adjustable cell, constraint cell, or any cell that is a function of adjustable cells.

### Dual Value of a Constraint Cell - Shadow Price

The dual value of a constraint is the rate of *improvement* in the best cell as the right-hand side of the constraint is increased. The dual value of a constraint is often referred to as the shadow price because it foretells the price you should be willing to pay for that item.

For example, in the XYZ sample model referred to earlier in *Getting Started*, dual values can be specified for the constraints in cells F15:F17. These could be put in any convenient place on the spreadsheet. We chose H15:H17 below:

The screenshot shows the following data in the spreadsheet:

XYZ COMPUTER CORPORATION PRODUCTION PLAN						
Product:	Standard	Deluxe				
Quantity to Produce:	60	30			PROFIT:	\$33,000
Profit per Unit:	\$300	\$500				
Product Component Requirements						
Components:	Quantity Required:		Total Usage		Number In Stock	
	Standard	Deluxe				
Standard Tower	1	0	60	=<=	60	
Deluxe Tower	0	1	30	<=	50	
Hard Drive	1	2	120	=<=	120	

The dual cells are inserted by highlighting the cells H15:H17, clicking on *WB!|Advanced...|Dual*, selecting F15:F17 for the *For Cell Range:* box, and clicking *OK*. When we re-solve, the dual values for the stock constraints will appear as in the following.

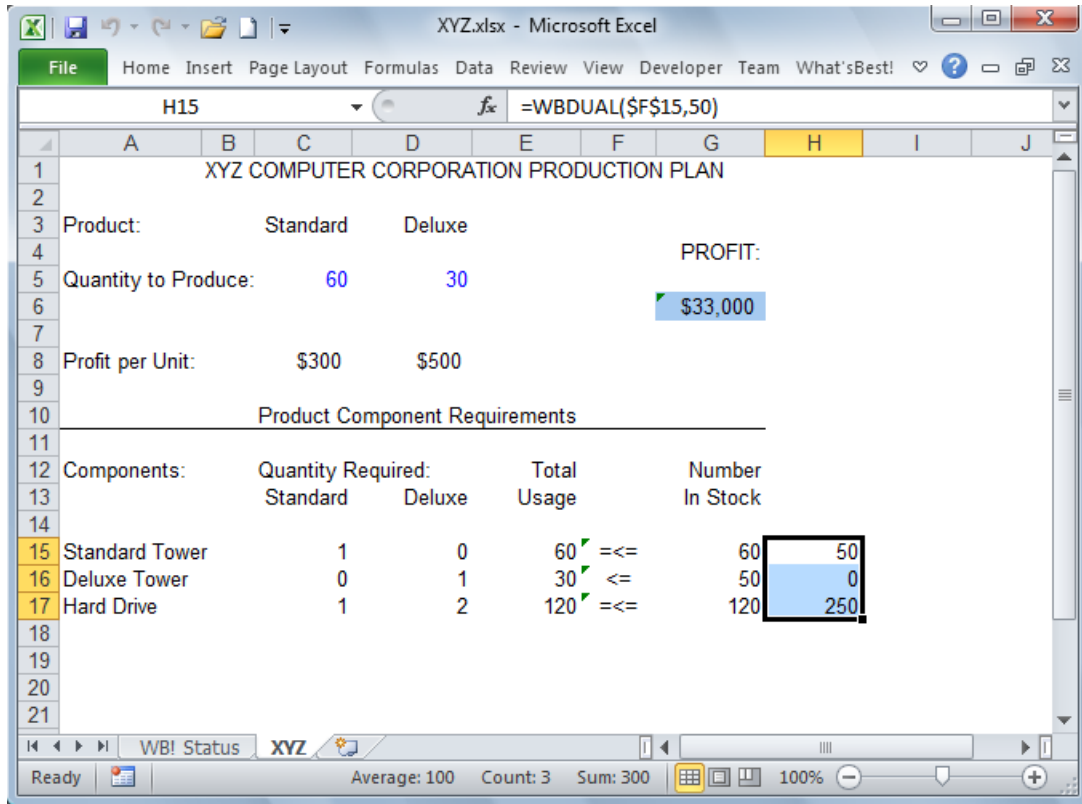

The dual value of the constraint function  $WB(E15, "<=" , G15)$  is shown in cell H15 as 50 (Note: You must re-solve your model to allow *What'sBest!* to update any new dual cells). This means the value of the best cell would improve by \$50 for each unit increase in the right-hand side of the constraint equation. In other words, changing the cell G15 to 61 and re-solving the model would return a new solution with a maximum profit of \$33,050 (assuming a valid range on the dual value of at least one). This is also the maximum price at which you should be willing to purchase an additional Standard computer tower.

**Note:** In *What'sBest!* we use the convention of having dual values on constraints return the *rate of improvement* in the objective for an increase in the constraint's right-hand side value. A positive dual implies that the objective will improve when increasing the right-hand side, while a negative implies that the objective will suffer. On maximization problems, as we have shown above, a positive dual value means that increasing the right-hand side of the constraint will cause the optimal objective to improve, or *increase*. On the other hand, for minimization models, if the sign of the dual is positive, then the optimal objective value will *decrease* as the right-hand side increases.

---

**Note:** If the constraint on Deluxe computer tower usage  $WB(E16, "<=" , G16)$  is not tight (i.e., E16 is not equal to G16, but is less than 50), then the dual value is 0. Increasing the right-hand side from 50 to 51 would not affect the optimal solution and consequently would not change the best cell value.

---

---

**Note:** When taking the dual value of a constraint, be sure to specify the cell containing the constraint *function*, not the right-hand side of the constraint.

---

## *Dual Value of an Adjustable Cell - Reduced Cost*

The dual value of an adjustable cell is the rate at which the best cell would be *penalized* if an adjustable cell with an optimal value of zero were forced into the solution—even though it is not optimal to do so. If the adjustable cell is a positive number, the dual value will always be 0. The dual value of an adjustable cell is often referred to as the *reduced cost* because it is the amount by which the cost of producing that adjustable item would have to be reduced in order to make it profitable.

The dual values for the adjustable cells can be placed in the model by clicking on the cells to put the information in, choosing *Advanced...|Dual*, entering the adjustable cells in the *For Cell Range* edit box, and clicking *OK*. The dual values can be placed in any convenient location in the spreadsheet.

For illustration, we continue with the XYZ model, changing the available number of hard drives (G17) to 50 and re-solving, causing the number of Deluxes (adjustable cell D5) to drop to 0 and the total profit to be reduced to \$15,000. We also requested dual values on our two adjustable cells, placing the dual values in cells C6:D6. After re-solving we get the following results:

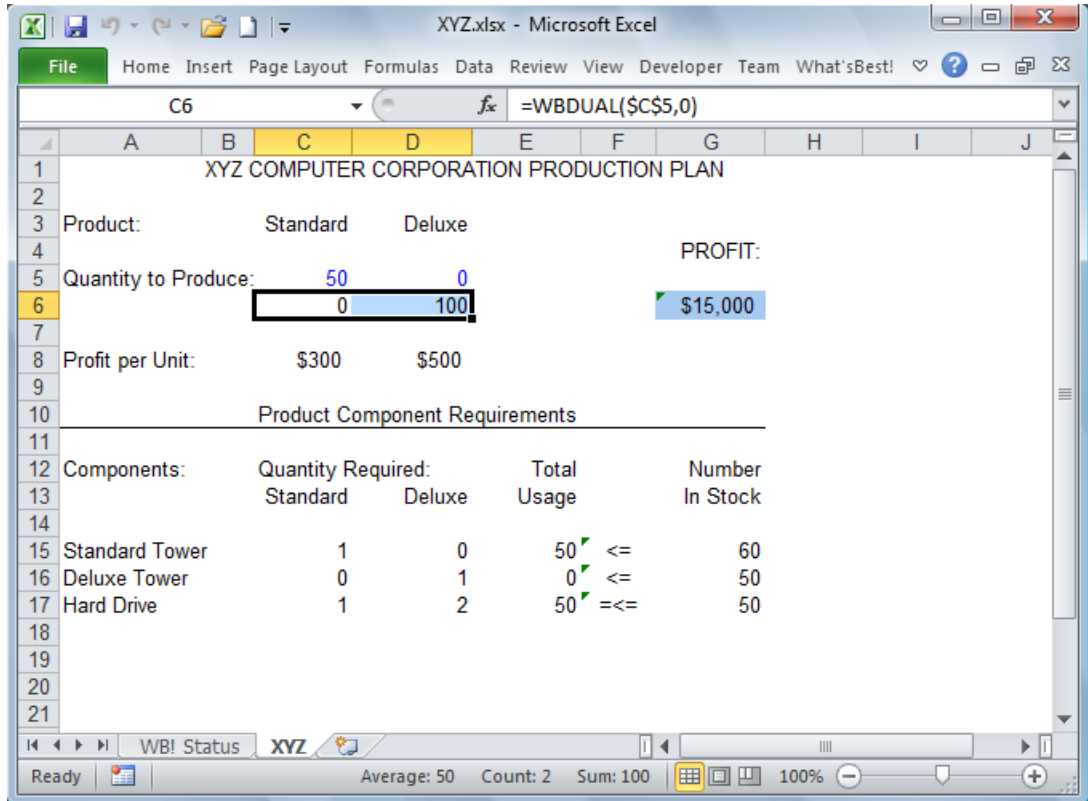

The dual value of adjustable cell D5 is now 100. This means the value of the best cell would be penalized (in this case decrease) by \$100 for each unit increase in D5. In other words, forcing the number of Deluxe computers from 0 to 1 would return a new solution with a profit of \$14,900 (\$15,000 - \$100) (assuming a valid range on the dual value of at least one—see the *Valid Ranges for Dual Values* section below).

In the window below, we show the re-solved model with the Deluxe adjustable cell forced to be 1 by putting the constraint  $=WB(D5,"=",1)$  in cell D7. As you can see, the dual value is now zero because the variable is in the solution. The quantity of Deluxe computers to produce could also be forced to one by choosing *Remove Adjustable* in the *Adjustable* dialog box or the toolbar button to make D5 into a non-adjustable cell and entering 1 as a constant value.

The screenshot shows the Microsoft Excel interface with the following data:

XYZ COMPUTER CORPORATION PRODUCTION PLAN					
Product:	Standard	Deluxe			
Quantity to Produce:	48	1		PROFIT:	
	0	0			\$14,900
Profit per Unit:	\$300	\$500			
Product Component Requirements					
Components:	Quantity Required:		Total Usage		Number In Stock
	Standard	Deluxe			
Standard Tower	1	0	48	<=	60
Deluxe Tower	0	1	1	<=	50
Hard Drive	1	2	50	=<=	50

The formula bar for cell D7 shows:  $=WB(D5,"=",1)$

**Note:** It is important to note that the dual value of a particular constraint or adjustable cell assumes all other information in the model remains unchanged. That is, given the dual information, you cannot predict the effect on the best cell of simultaneously changing two, or more, constraints.

## *Dual Value of Zero and Multiple Optima*

Dual values are generally positive for adjustable cells that have a zero value in the optimal solution. An exception to this occurs when there are multiple optima (i.e., more than one combination of adjustable cell values that yield the same optimal objective value) because no penalty is incurred in moving from one optimal solution to an alternative one. If your model yields zero dual values for any of the adjustable cells, it's likely that there are multiple optima for your model.

## *Dual Values in Nonlinear Problems*

Dual values in a nonlinear problem can be interpreted usefully only for small changes in the right-hand side. It may not be possible to make assumptions about the effect of large changes in a nonlinear model. You may want to investigate the effect of such changes manually by inserting proposed changes and re-solving.

Users with knowledge of calculus can think of the dual value as a derivative — the rate of change of the best cell value with respect to changes in either the right-hand side of a constraint or an adjustable cell value. As with the derivative of a linear function, a dual value in a linear model has a constant value over a range. In nonlinear models, the dual value is similar to the derivative of a nonlinear function—it is valid at the point where it's evaluated, but it may change immediately as you move from that point.

## *Dual Values in Integer Problems*

Dual values for problems with integer variables cannot be usefully interpreted because of the way the branch-and-bound technique solves integer models. If a dual value is requested in an integer model, What's*Best!* will return a value. However, this value is of no practical use.

## *Valid Ranges for Dual Values*

You may also wish to determine the upper and lower ranges of any specified dual value. Changing the right-hand side of a constraint or using more or less of a resource, as described above, eventually will cause a change in the dual value. The valid range for a dual value is the amount of change in the right-hand side of a constraint, or in resource use in an adjustable cell, that is possible before a change in the dual value will occur.

The range over which the use or availability of a resource, or the right-hand side of a constraint, can decrease before the dual value changes is called the *lower range*. The range over which the use or availability of a resource, or the right-hand side of a constraint, can increase before the dual value changes is called the *upper range*.

---

## Constraint Ranges

For example, building on the XYZ example, an upper and lower range can be determined for the dual values of the stock constraints. These ranges are put into the model by highlighting the cells you would like the range to appear in, selecting *Advanced...|Dual*, specifically selecting the constraint cells (F15:F17) to display in *For Cell Range*, choosing *Upper Range* or *Lower Range*, whichever is appropriate, and clicking *OK*.

**Note:** The default value entered in the *For Cell Range* is G15:G17, which is not the range of the constraint cells. You must make the correction to F15:F17 in order to obtain the true range values.

In the illustration below, we used cells I15:I17 and J15:J17 for the upper and lower ranges respectively and then re-solved. Again, we could have placed the dual value cells in any convenient location in the workbook.

XYZ Computer Corporation Production Plan

Components:	Quantity Required:	Total Usage	Number In Stock	Dual Value	Lower Range	Upper Range
	Standard	Deluxe				
Standard Tower	1	0	60	50	40	60
Deluxe Tower	0	1	30	0	20	1E+30
Hard Drive	1	2	120	250	60	40



The ranges for the Standard computer tower stock constraint are 60 upper and 40 lower. That is, the dual value will stay at 50 as the number in stock varies from 20 (60 - 40) through 120 (60 + 60). If the right-hand side of the equation is increased to the limit of 120 and the model is re-solved, the profit increases to \$36,000 ( $\$33,000 + (50 \times 60)$ ) as shown in the following:

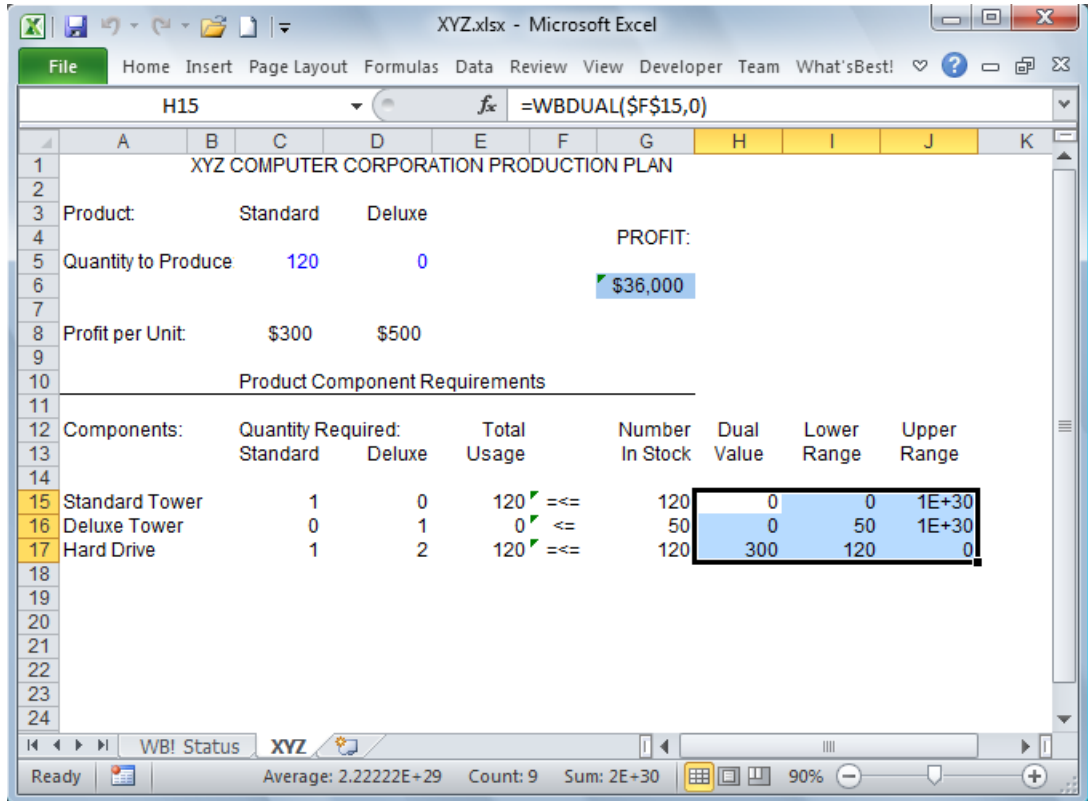

Increasing the right-hand side of this constraint beyond 120 exceeds the upper range for the original dual value of 50 and a dual value of 0 is now in effect. Since the dual value is \$0, changing cell G15 to 121 and re-solving the model does not increase the profit beyond \$36,000 as shown in the following:

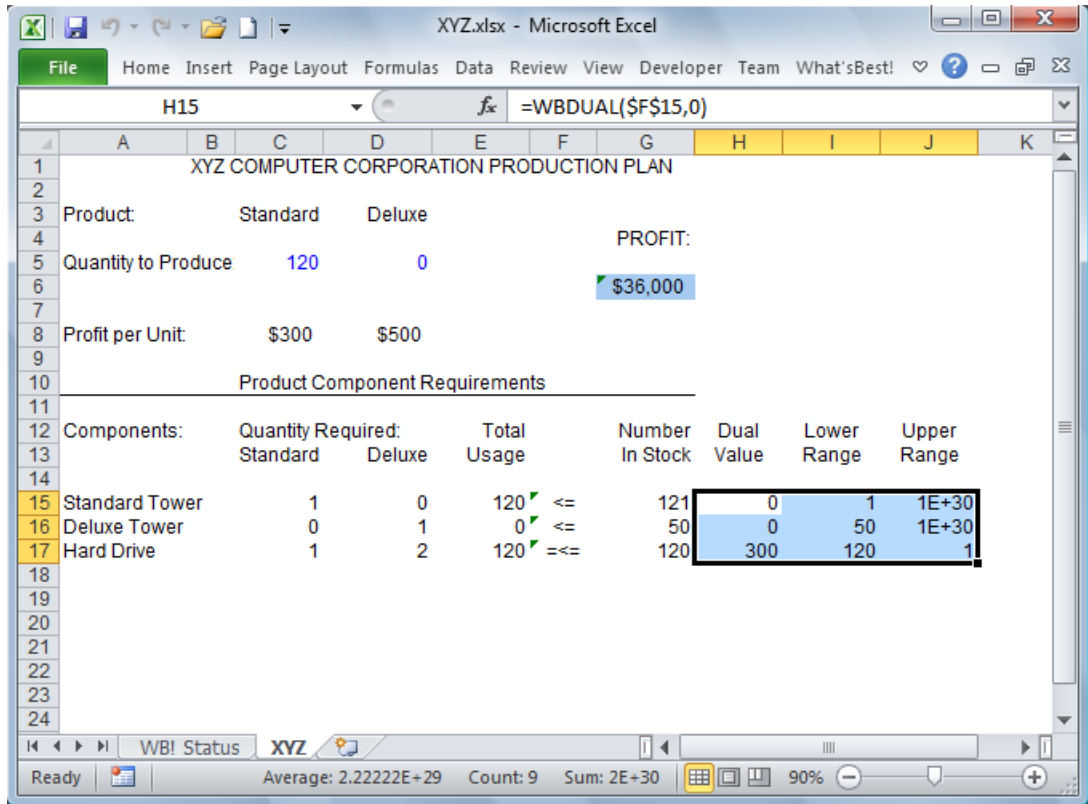

### Adjustable Cell Ranges

In the XYZ Production example, the adjustable cells refer to the production of Standard and Deluxe computer tower models. The dual value of each of these adjustable cells is the amount by which the profit of producing the models would have to increase in order to make it profitable to put them into the solution. The upper and lower range of the dual of an adjustable cell is the range over which the adjustable cell could change with its dual value remaining the same.

We will use the example referred to earlier for the adjustable cell dual value where the number of hard drives in stock is reduced to 50. An upper and lower range value can be put in the model by selecting the cell to put the dual information in, selecting *Advanced...|Dual*, selecting the adjustable cells (D5) to enter in the *For cell range:*, choosing *Upper Range* or *Lower Range*, whichever is appropriate, and clicking *OK*. In the box below, we used cells D6 and E6 for the lower and upper ranges respectively and then re-solved.

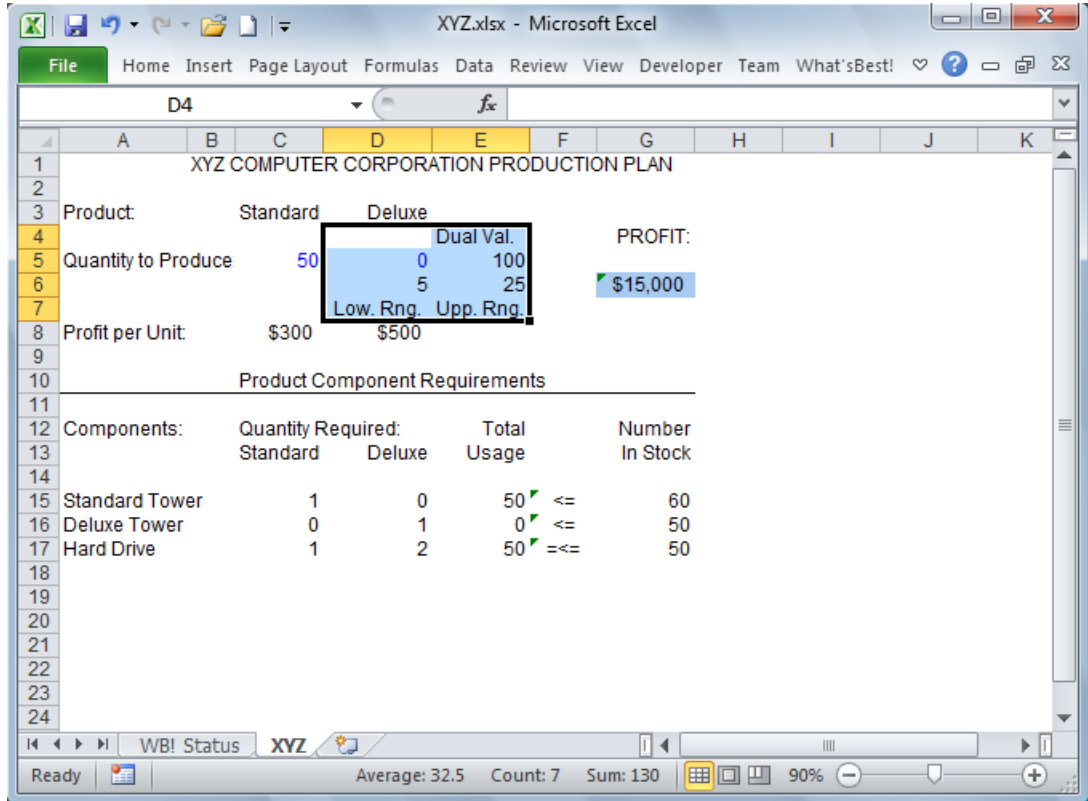

The ranges for the number of Deluxe computer towers to produce are 25 upper and 5 lower. That is, the dual value will stay at 100 as the quantity of Deluxe computers to produce varies from -5 through 25. If cell D5 (Quantity to Produce) is increased to 15, made non-adjustable using the *Remove Adjustable* command via the *Adjustable* dialog box or the toolbar button, and the model is re-solved, then profit decreases to \$13,500 ( $\$15,000 - (100 \times 15)$ ) as shown in the following.

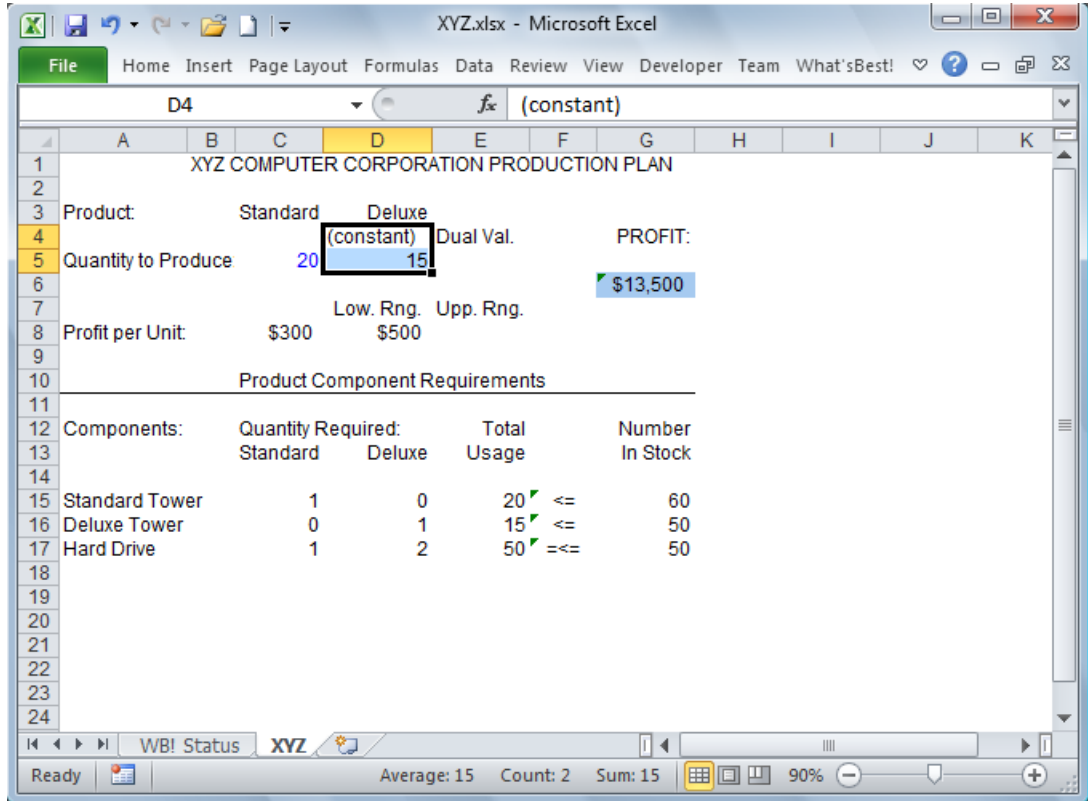

Note that, since the dual value formulas now refer to a non-adjustable cell, *What'sBest!* ignores these cells and they are not changed. If the quantity of Deluxe computers to produce is decreased to -3 and the model is re-solved, the profit increases to \$15,300 ( $\$15,000 - (100 \times -3)$ ) and the number of Standard to produce increases to 56 as shown in the following. This might occur if there are three obsolete Deluxe models and they are taken apart for the common parts used in the Standard model.

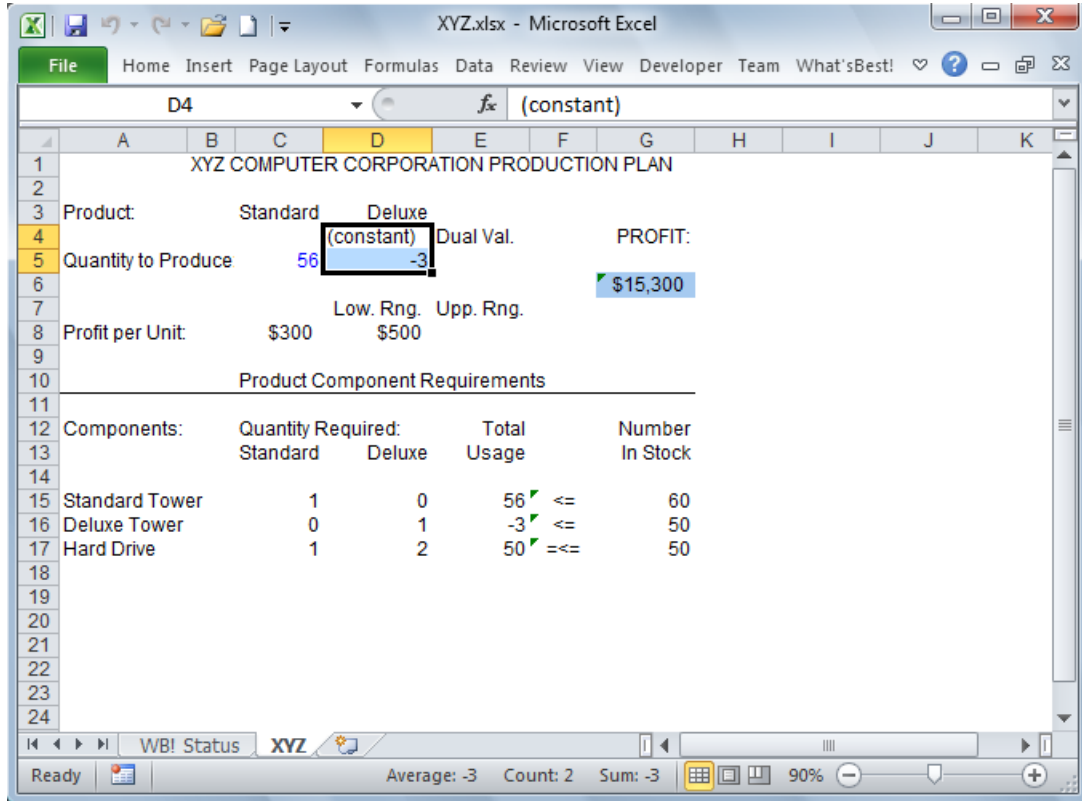

In this problem, if the original lower bound is exceeded by one (-6), the dual value is reduced to zero. If the original upper bound is exceeded (26 or more), the number of hard drives in stock is insufficient and the model is infeasible. Either way, the dual value changes when the range is exceeded.

In some problems, the range of a dual value may be very small or zero. When this occurs, you may find that different starting solutions result in different dual values. This may also indicate that more than one combination of the adjustable cells will result in the optimal value of the best cell. In this case, your model is said to have multiple optima. In any event, before making use of dual values in decisions of economic importance, you should investigate the range over which they're valid.

To retrieve dual values for all adjustable and constraint cells without entering dual value formulas in the worksheet, you may request a solution report with the *Options...|General* command.

## Advanced...|Omit...

The dialog box posted by the *Advanced...|Omit* command appears as follows:

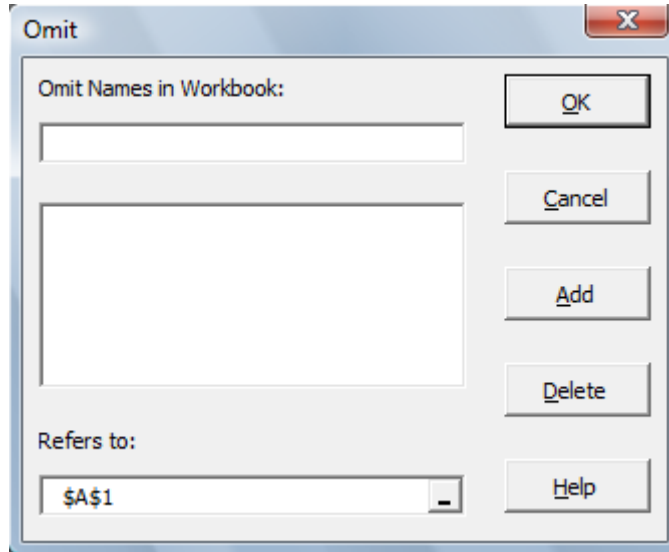

The *Omit* command allows you to specify a range of cells on the workbook to be ignored by the *What'sBest!* solver while it is seeking a solution. These omitted areas do not contribute toward any limits *What'sBest!* imposes in restricted size versions.

If used properly, omit ranges can decrease the solution time. However, care should be exercised in applying omit ranges. Please refer to the section entitled *Usage Guidelines for Omit*.

### *OMIT Names in Workbook and Refers to*

*What'sBest!* uses range names to specify the cell range to be omitted. The target cell range is indicated in the *Refers to:* box. *What'sBest!* automatically fills the *Refers to:* box with the range of the currently selected cells. If this is not the range of cells you want omitted, you can type the correct range in or select the button on the right edge of the text box to bring up a cursor for cell selection. Next, enter any word of your choice in the *OMIT Names in Workbook* box and click on the *Add* button. The name you entered should then appear in the box below with a *WBOMIT* prefix.

If you decide later you would like to remove the omit restriction, simply go to the *Omit* dialog box, select the name of the omit range to remove from the list of names, and click on the *Delete* button.

# Usage Guidelines for Omit

## What To Omit

You may use the *Advanced...|Omit* command to remove parts of your workbook from What'sBest!'s consideration, thereby decreasing the time to reach a solution. If you can identify cells with a numeric value or equations that are extraneous to the problem being solved, then you can place them in an omit range. For example, some cells in the spreadsheet may be used for evaluation and reporting and are not used in finding the solution. If these cells contain unsupported spreadsheet functions, placing them in an omit range will eliminate the error message caused by the equations. If they contain equations that depend upon adjustable cells, placing them in an omit range can shorten the time required for solving.

## What Not To Omit

What'sBest! will ignore the values and equations of every cell within an omit range. Therefore, it is very important that information pertinent to the problem is not included in an omit range. For example, you should be especially careful not to include:

- ◆ *Adjustable cells* - Any adjustable cell within an omit range will not be adjusted during the solution process.
  - ◆ *Constraint cells* - Any constraint cells included in an omit range will be ignored during the solution process.
  - ◆ *Cell Precedent to Equations Outside Omit Range* - An equation outside of any omit range that references a cell within an omit range will cause the solution to be aborted with an error message and the unsolved model will be returned.
-

## Advanced...|Function Support

This feature allows you to build models using not only Microsoft® Excel® built-in functions, but also user defined functions. The user defined functions can be VBA macros, add-in file .XLA, macros calling a user add-in file .XLA, .XLAM, or a library file .XLL. This feature is useful if the user has to develop his own function and wants these functions to be integrated in the optimization model. The function support and add-in names are entered using the following dialog box:

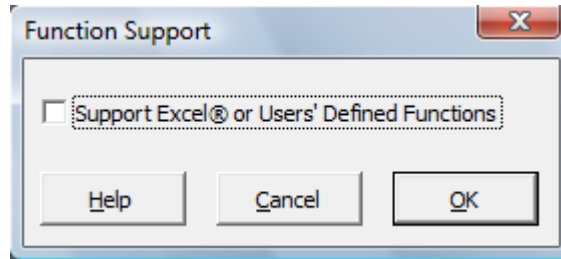

### Function Support

By checking this option, every function will be supported in the model. Otherwise, *What'sBest!* will treat user written functions as unsupported functions, and will read the cell as a constant equal to its numeric value at the start of optimization.

This support of user functions will make the model bigger, more complex, and so may make solution time longer.

In Microsoft® Excel® 2002, you may need to adjust a setting from the menu "Tools|Options|Security|MacroSecurity|TrustedSources" so as to grant any project access. Thus grant any project access. Check the box "Trust Access to Visual Basic Project", save your model and reopen Excel®.

In Microsoft® Excel® 2007, adjust the security setting from the Excel® Options, then click on "Advanced|TrustCenter|TrustCenterSettings". Enable macros and grant the same access in the "Macro Settings" tab.

In case of your add-in has been digitally signed, you will need to enable this add-in to run your model. In some situations, a time delay may occur after enabling the add-in.

Refer to the *What'sBest!* sample file *Shipping\_MacroFunctions.xlsxm* for an example of valid user defined function usage.

The default setting is False (unchecked).



## Advanced...|Statistical Functions

This feature allows you to view the specific statistical functions available for *What'sBest!*.

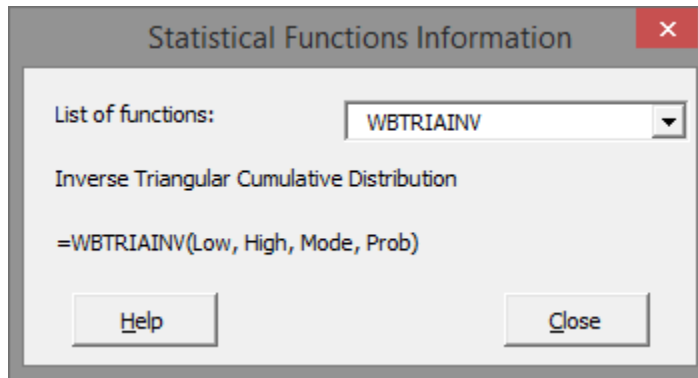

See the part Statistical Functions for additional information.

## Advanced...|String Support

This feature allows you to build models using strings as arguments, e.g., in functions such as IF(), VLOOKUP(), and SUMIF().

String support related settings are entered using the following dialog box:

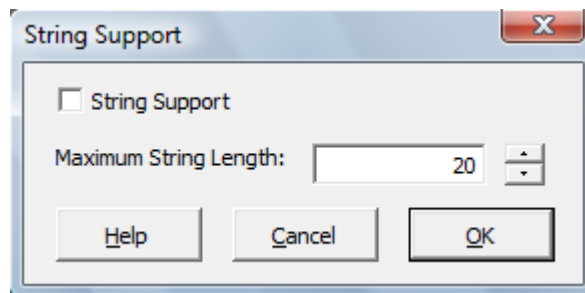

### String Support

By checking this option, string arguments will be supported in the model. Otherwise, *What'sBest!* will treat strings as arguments with a numeric value of zero.

String support may make the model bigger so it may need more resources to be solved.

The default setting is False (unchecked), which means string arguments will be read as a 0 value number.

## Maximum String Length

This length can be set between 1 and 255. By making this setting small, you reduce the memory required by the string support feature, however, making the max string length too small may truncate two different strings, such as “New\_York” and “New\_Jersey”, make them appear to be identical, and lead to incorrect results.

The maximum string length default value is 20 characters.

**Note:** If the *String Support* option is set to FALSE, then the *Maximum String Length* setting will be disregarded.

String operations are allowed only in variations of compare, such as "=", "<>" (symbol for not equal), ">", "<", ">=", "<=", SUMIF(), and VLOOKUP() functions. Any other operations will return an error message. Also, a formula cell should return a numeric number rather than a string value.

## Advanced...|Convert Model Format

This feature allows you to convert a non-What'sBest! format spreadsheet optimization model to What'sBest! format. It will try to extract any existing data or information to set the Adjustable, Best cells, and it will create a new tab 'WB!\_Constraint\_Sheet1' at the end of the workbook for inserting the constraint functions.

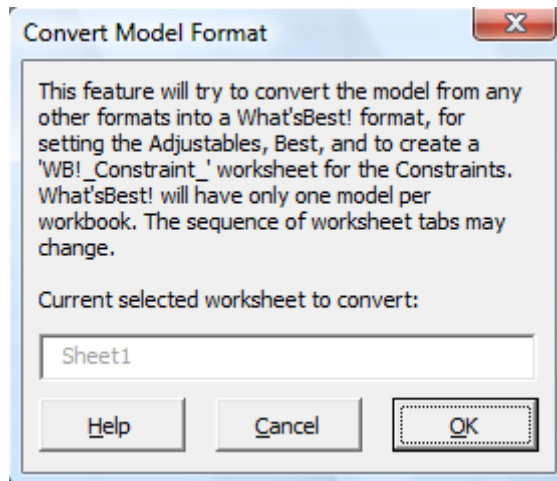

### Current Selected Worksheet to Convert

What'sBest! can have one model per workbook, but other spreadsheet modeling interfaces can have one model per worksheet. The user needs to select the current worksheet to convert, then invoke the feature. The feature will apply the Adjustable Style for the decision variable cells, the WBMIN or WBMAX Name for the Objective cell, and create the '=WB()' functions in a separate tab 'WB!\_Constraint\_Sheet1' at the end of the workbook.

---

The user may need to reset the tolerances via the numerous *Additional Commands* dialog box for the type of the model. What'sBest! will then detect automatically the type of the model once the user starts the solver via the *Solve* button.

For instance, the workbook has several tabs, but you want to convert the model in 'Sheet1'. Select the tab 'Sheet1', go to Advanced... and Convert Model Format via the WB! menu, and press OK. You will see the Adjustable cells with a blue-like font, the Best cell with a blue background, and the tab 'WB!\_Constraint\_Sheet1' for the constraints functions, such as =WB(Sheet1!A1, "<=", Sheet2!C1).

---

**Note:** This feature creates a new model format, but does not remove the existing format. Any cells difference that could not be transported will be listed in the status report.

---

This feature cannot be invoked via the VBA interface.

## ***Advanced...|Parameters***

This feature allows you to set arbitrary parameters in the LINDO API, which is the solver engine used by What'sBest!. In order to solve your model successfully, there may be rare occasions when you will need to set an API parameter that is not available through the normal What'sBest! interface. If this is found to be the case, you will be provided with a list of settings by a LINDO Systems Technical support representative after investigation of the model.

---

**Note:** The *Advanced...|Parameters* command should only be used with guidance from LINDO Systems technical support.

---

The parameter names and their values are entered using the following dialog box:

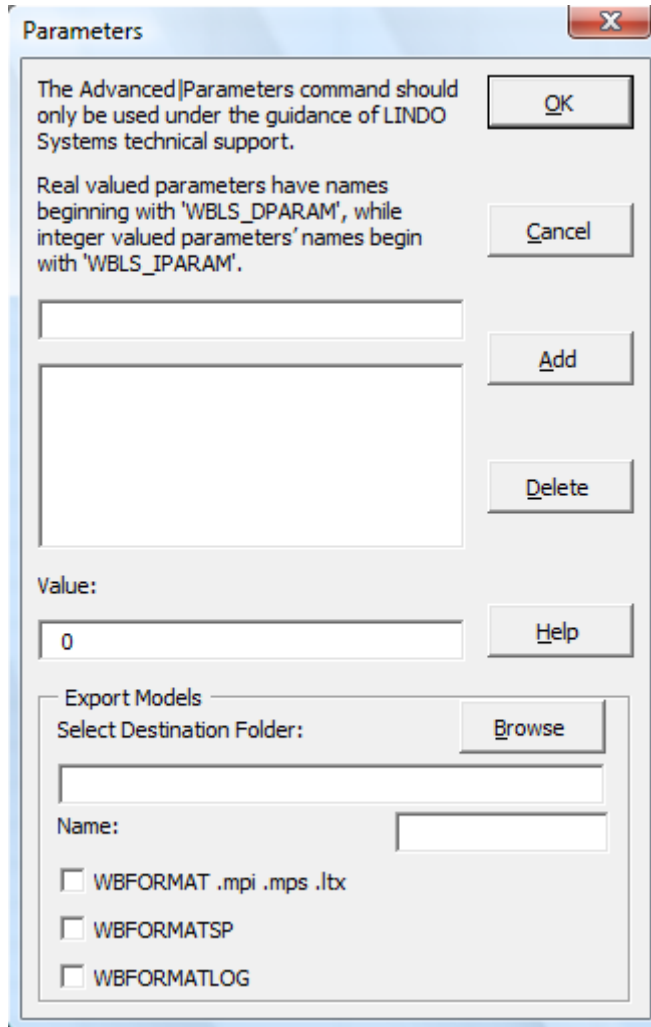

The WB!Options|Reset to Default command will not reset the custom parameters defined in this window. Instead, you must delete them individually using the Delete button pictured above.

In addition, What'sBest! will accept two names for providing the instruction list and a parameter file in a standard format.

- WBFORMAT, will produce a .MPI, .MPS, or .LTX file format in the specified destination; for instance:  
"C:\Temp\modelname.mpi". The parameter file is provided as a .PAR and .CSV.

- WBFORMATSP, will produce the formatted files related to a Stochastic Program model; for instance:  
 "C:\Temp\stochasticmodelname" (without extension), for .MPI, .SMPI, .STOCH, .TIME, \_1.STOCH. The parameters file is provided as \_PARAM.TXT and \_PARAM.\_PARAM.CSV.
- WBFORMATLOG, will produce the formatted files related to an output log file from the calculation library; for instance:  
 "C:\Temp\logname.txt".

There is also a hidden name that the user can setup, as WBCALCxxx with a range value, which actually tells *What'sBest!* to read the cells in the range as constant values, and ignoring any formulas in these cells. This name can be useful to bypass the reading of an external link to the model contained in a cell, or an unsupported function, but may also break any dependencies to other parts of the model when *What'sBest!* reads and parses the model from the spreadsheet.

All the *What'sBest!* names can be defined, modified, or deleted via the Name Manager of Excel®.

Users accessing *What'sBest!* via VBA macros can set customer parameters by using the standard VBA code, for instance:

```
ActiveWorkbook.Names.Add Name:="WBLS_DPARAM_ANYPARAM", _
    RefersToR1C1:="=1.23"
```

## Locate...

The dialog box posted by the *Locate* command appears as follows:

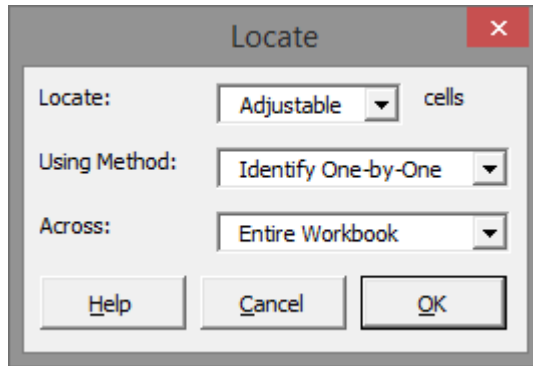

Specify the type of cell you would like to find in the *Locate:* drop-down box to search the worksheet or workbook for Adjustable, Best, Constraint, Violated, Dual, WBCALC, or WBOMIT cells.

If you choose to locate the best cell, then *What'sBest!* searches the entire workbook for the maximized or minimized cell and selects that cell.

If you choose to locate *Adjustable*, *Constraint*, *Violated*, *Dual*, *WBCALC*, or *WBOMIT* cells, then specify whether you wish to simultaneously *Select All Such Cells* or *Identify One-by-One* with the *Using Method* drop-down box. The search can focus either across the *Worksheet* or the *Workbook*.

To *Identify One-by-One*, *What'sBest!* proceeds to search by row following by column until it finds the first such cell. If there are more cells of the same type across the worksheet or workbook, then the following dialog box appears:

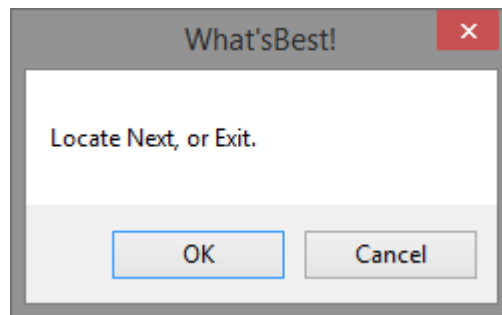

For example, if the current cell is A1, you are searching for adjustable cells one-by-one, and A2 and B1 are both adjustable cells, the next cell selected will be B1.

Finally, select whether you want *What'sBest!* to search across the *Entire Workbook* or *This Worksheet* in the *Across:* drop-down box. If no cells of the type you requested are found in the worksheet or workbook, then *What'sBest!* lets you know.

# Help & About What'sBest!

The dialog box posted by the *About What'sBest!* command appears as follows:

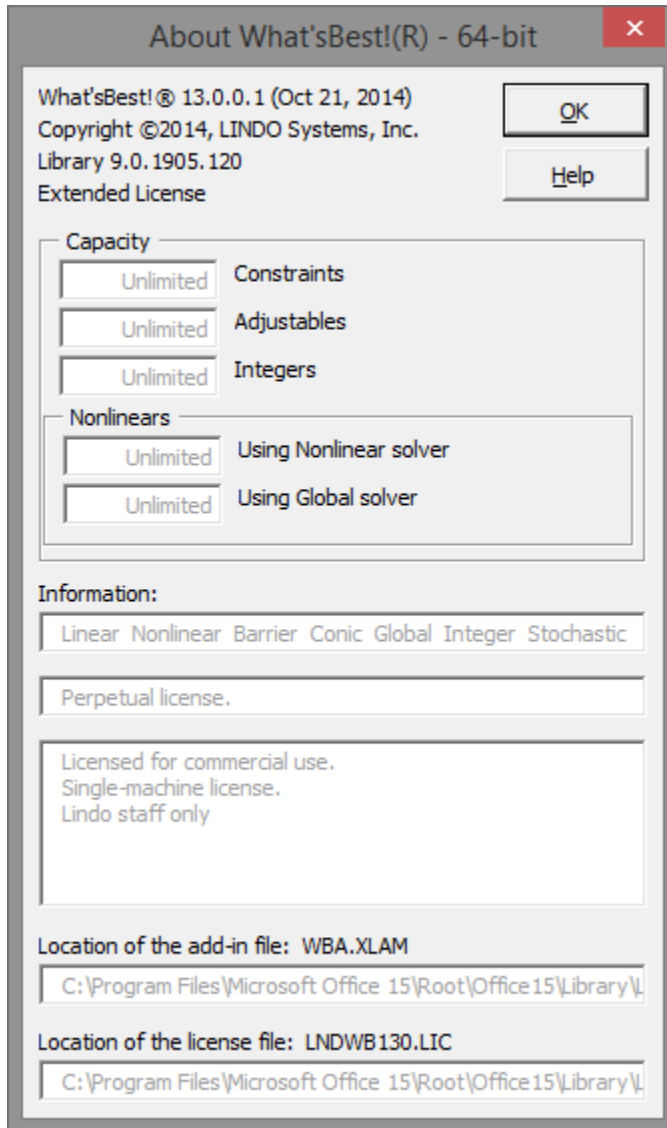

---

The *About What'sBest!* dialog box provides information about which version of *What'sBest!* you are running and its capacity according to the license key you possess (If you do not have a license key, you can run a Demonstration/Trial version of *What'sBest!*). In addition, the box at the bottom of the dialog box supplies the location of the *What'sBest!* add-in file (*WBA.XLA* or *WBA.XLAM*) with the necessary accompanying files to run *What'sBest!*, and the location of the license file (*LNDWBxxx.LIC*) which has to be in the same location of the add-in. The capacity and size for the different versions of *What'sBest!* are as follows:

<b>Name</b>	<b>Constraints</b>	<b>Variables</b>	<b>Integers</b>	<b>Nonlinear</b>	<b>Global</b>
Trial Version	150	300	30	30	5
Personal Version	250	500	50	50	5
Commercial Version	1000	2000	200	200	10
Professional Version	4000	8000	800	800	20
Industrial Version	16000	32000	3200	3200	50
Extended Version	<i>Unlimited</i>	<i>Unlimited</i>	<i>Unlimited</i>	<i>Unlimited</i>	<i>Unlimited</i>



# Toolbar / Ribbon Bar

In Excel® versions 2002-2003, use the *ToolBar* command to toggle the *What'sBest!* toolbar on and off. When *What'sBest!* is installed, the toolbar appears in floating (undocked) mode as follows:

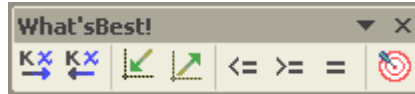

The user may then reposition the *What'sBest!* toolbar to a preferred part of the Excel® window. Select the *ToolBar* command to turn the toolbar off. Select it again to turn the toolbar back on. A checkmark will appear next to the *ToolBar* command when the toolbar is on.

The *What'sBest!* toolbar offers rapid one-click access to eight of the most commonly used operations. The *What'sBest!* toolbar also makes tool tips available. To learn the function of a particular toolbar button, just move the cursor over the button for a second and a statement of the button's function will appear.

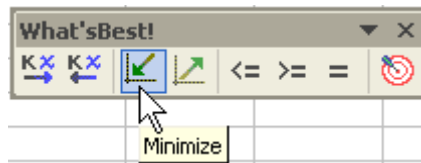

Should you wish to remove the *What'sBest!* toolbar, you would use *View|Toolbars|Customize...* command, select the *What'sBest!* toolbar, and press the *Delete* button. You would then have to reinstall *What'sBest!* in order to restore the toolbar.

In Excel® versions 2007-2013, *What'sBest!* just shows an additional tab in the Ribbon Bar layout, with an easier access to the dialog boxes and the shortcuts:

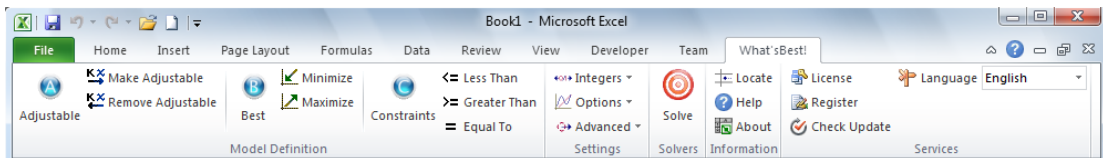

## License Key Entry

The dialog box posted by the License command appears as follows:

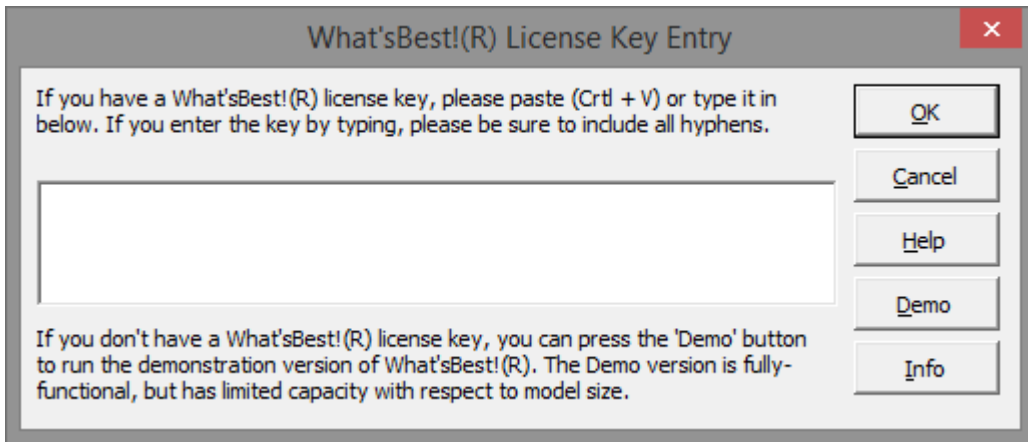

Use this command to input your *What'sBest!* license key.

If you have already purchased a larger version of *What'sBest!*, you will find your *What'sBest!* license key enclosed with your CD. Please enter the license key in the text box exactly as it appears, including all hyphens, and press the OK button. If you have requested and received a license key via e-mail, even a trial key, you may copy-and-paste it directly into the space provided (Ctrl-C to copy, Ctrl-V to paste).

This command can also be used to upgrade *What'sBest!* to handle larger problems (greater number of constraints, variables, and integers) or to add options to solve other types of problems. To upgrade, simply obtain a new license key from LINDO Systems and enter it here, then select OK.

If you would like to run the downloaded demonstration version of *What'sBest!* (150 constraints, 300 variables, 30 integers, 30 nonlinear variables, and 5 global variables), just click the Demo button. This is a fully functional license, but is limited in capacity, and will replace any already existing license.

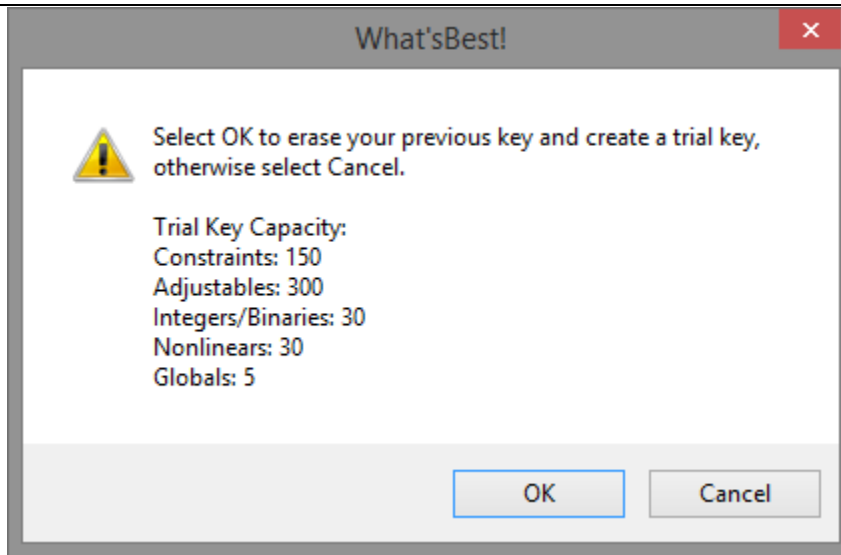

The User Information File is created upon request of LINDO Systems, by clicking the Info button. It contains the Machine Name, the User Name, and the Disk Identification Number. This file USERINFO.TXT can then be sent to LINDO Systems, so to create the full license key for academic purpose. By default, this file will be created in the What'sBest! add-in folder, but a different folder can be selected, usually in the local disk drive.

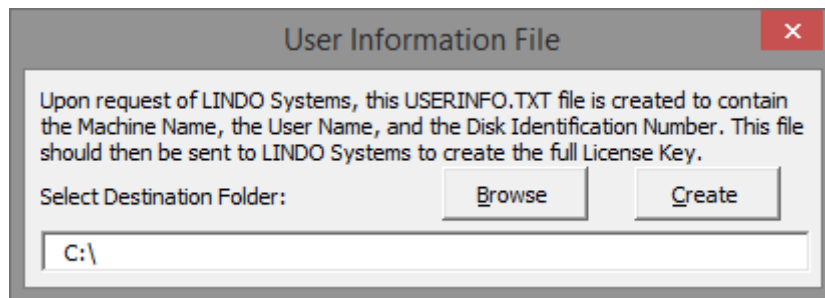

Also, you may need to verify where your license key is stored. The license file, LNDWBxxx.LIC, is located in the same directory as the What'sBest! add-in files.

The About What'sBest! will show your license capacity currently installed.

If you have lost your license key, please contact LINDO Systems.

# Register...

The dialog box posted by the Register command appears as follows:

**LINDO Systems Product Registration - 64-bit**

Serial Number :

License :

Name \*:

Title :

Company \*:

Address :

City :  State :

Zip Code :  Country \*:

Phone \*:

Fax :

Email \*:

What is your company's primary business ?

Education       Consulting       Manufacturing

Accounting       Government       Petrochemical

Agricultural       Medical       Transportation

Financial       Marketing       Other

Telecommunications       Insurance     

What other optimization package have you used ?

What will be your primary application of this product ?

Comments :

\* Required Field

Use the Register command to register your version of What'sBest! online. You will need a connection to the Internet for this command to work. Enter the personal information you deem relevant and select the Register button. Your information will be sent directly to LINDO Systems via the Internet.

Once your registration is complete, the following dialog box will appear on your screen:

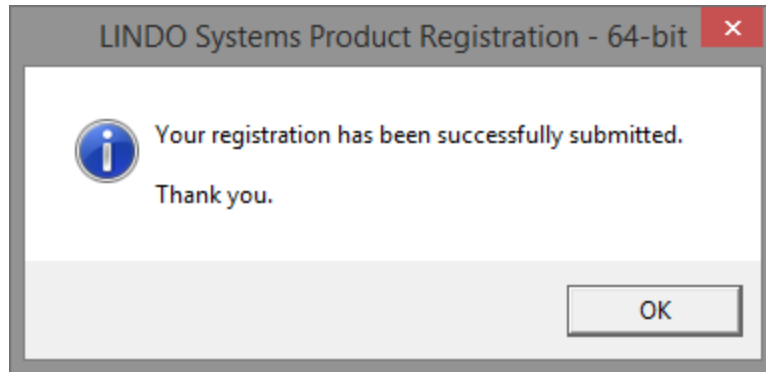

Select the OK button to be returned to the main Excel® environment.

LINDO Systems is constantly working to make our products faster and easier to use. Registering your software ensures that you will be kept up-to-date on the latest enhancements and other product news. You can also register through the mail or by fax using the registration card included with your software package.

---

## CheckUpdate...

Turn the *CheckUpdate* command on to have What'sBest! automatically check every time you start the software if there is a more recent version of What'sBest! available for download on the LINDO Systems website. ***You will need an Internet connection to the Internet for this command to work.***

When you issue the *CheckUpdate* command, or start a version of What'sBest! with *CheckUpdate* enabled, What'sBest! will search the Internet to see if an updated version of the software is available for download. If you currently have the most recent version, then you will be returned to the main What'sBest! environment. If a newer build of the software is available, you will be presented with the following dialog box:

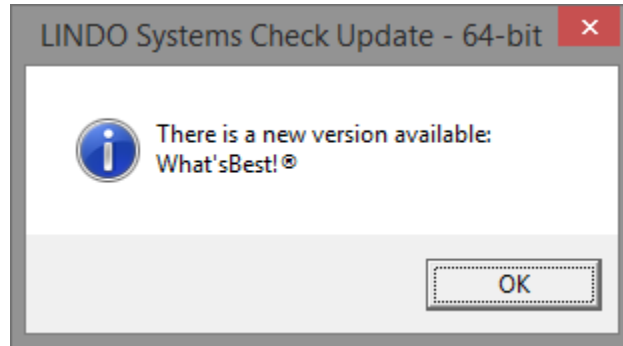

A checkmark next to the command in the WB menu indicates that the command is still enabled. You will need to download the new version of the software from the Website at the address indicated. You can disable this option by checking off the command item.

Upon completion of downloading, you will be prompted to begin installation of the new update. Close Excel®, and double click on the file to open the install wizard, which guides you through the setup process to update *What'sBest!*. For your convenience, your license key will be automatically transferred to the new version during installation.

Keeping your software up to date helps ensure that you are using the most recent version of the software and that compatibility and operational problems are kept to a minimum.

---

# Language

This feature allows the user to select the language of his choice without reinstalling the add-in.

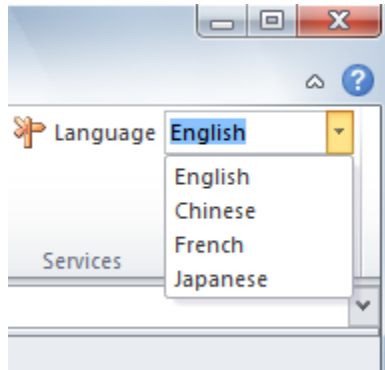

After selecting the language, the user can revert to the previous setting, because the language words will stay displayed in the native language. Make sure that your system has installed the international language capabilities. This can be verified via the Control Panel of the Windows® operating system.

**Note:**

English (US)  
Chinese (Pinyin)  
French (France)  
Japanese (Katakana)





---

# 4 *What'sBest! Macros: The VBA Interface*

---

This section discusses the VBA (Visual Basic® for Applications) interface of *What'sBest!*. The VBA interface allows the user to write VBA code or macros that execute *What'sBest!* commands. By using this interface, you can build optimization applications that utilize all the power and functionality of *What'sBest!* in Excel® or any other application offering VBA control.

The section entitled *Usage Guidelines for Macros in VBA* introduces some features of the VBA interface such as the *Object Browser*, how to embed your *What'sBest!* model in a Visual Basic® project, as well as how to hide the model. The procedures or functions (such as *Adjust*, *Best*, and *Constraint*) provided by *What'sBest!* are discussed in *VBA Interface: Procedures*. The section entitled *Tutorial on the VBA Interface* is provided to help you get started writing VBA. The rest of the section describes the syntax, arguments, and error codes of particular procedures.

---

## ***Usage Guidelines for Macros in VBA***

### *Introduction to the VBA Interface of What'sBest!*

The very first step in creating a macro for *What'sBest!* is to create a reference to the *What'sBest!* add-in, so you can use the add-in's attributes and procedures. This reference to *What'sBest!* is made by checking the *WBA.XLA*, or *WBA.XLAM*, box under *Tools|References* from within the *Visual Basic® Editor* (The *Visual Basic® Editor* is called via *Tools|Macros* from the main Excel® menu bar). If you do not create this reference, then when your code attempts to call the *What'sBest!* attributes or procedures Excel® returns the error message *Sub or Function not defined*.

### ***Object Browser***

Excel®'s *Object Browser* is a useful tool for developing macros that run *What'sBest!*. The *Object Browser* provides for display of all publicly declared objects within a given unit of code, such as a module or the *What'sBest!* add-in (*WBA.XLA* or *WBA.XLAM*). Once you've selected such an object, the *Object Browser* provides a view of all objects, procedures, and attributes that are available to any macros you write for that object. For example, by selecting the *What'sBest!* add-in object (*WBA.XLA*) within the *Object Browser*, you can view the particular attributes and procedures of *What'sBest!* that you can employ in a macro.

---

The *Object Browser* is a feature of the *Visual Basic® Editor* and is opened from the Excel® menu by *Tools|Macro|Visual Basic Editor*. Having opened the *Visual Basic® Editor*, select *View|Object Browser* to start the *Object Browser*. From the *Object Browser*, you designate *What'sBest!* as your object by selecting *WBA.XLA* for the Library/Workbooks (instead of *<All Libraries>*). If you do not see *WBA.XLA* in the drop-down list, then you must check in the *What'sBest!* add-in via the Excel® menu's or Ribbon's *Tools|Add-ins* or re-install the *What'sBest!* add-in.

After you've selected *WBA.XLA* in the *Object Browser*, you should see *WBUUsers* among the *Classes* listed. This class is your primary source of *What'sBest!* procedures. As you select this class, the right window should display all of the *Members* (procedures) available to you from that class.

## Macro Recorder

Excel®'s *Macro Recorder* can be a very valuable tool for creating macros of tasks in Excel®. Unfortunately, it generally does not work well in conjunction with Excel® add-ins such as *What'sBest!*. The *Macro Recorder* of Excel® 97 and later versions is unable to record the *What'sBest!* add-in commands, so we recommend you do not try to use it to generate VBA code. You can use Excel®'s *Object Browser* described above to more quickly and accurately write your VBA code.

## Calling Procedures

Visual Basic® for applications is quite liberal in the syntax it allows when calling procedures. For the sake of simplicity, the calling procedures used for illustration below will stick to one or two conventions depending upon whether or not named arguments are used. For example, to call the procedure to set cells D8:E10 as adjustable without named arguments would be:

```
wbAdjust "D8:E10"
```

The same procedure call with named arguments would be:

```
wbAdjust AdjRange:= "D8:E10"
```

---

**Note:** VBA is case-insensitive to the procedure name when it is called, so the procedure could alternately be called with its name typed entirely in upper case (i.e., as *WBADJUST* instead of *wbAdjust*).

---

Named arguments such as shown above are necessary when you are skipping over some arguments. With some programming languages, it is possible to skip an argument by leaving it blank. This is not possible with VBA. Named arguments must be used instead:

*INVALID:* `wbSetGeneralOptions ( , , , , , , , , False, True, True, , , , , )`

*VALID:* `wbSetGeneralOptions goStatusReport:=True, goSolutionReport:=False, goWrnBlank:=True`

When calling procedures with multiple arguments, using named arguments allows you to list the arguments in any order you choose. Using named arguments can also make the code easier to read.

## *Error messages you might encounter learning VBA.*

When initially learning to run *What'sBest!* using VBA code, the user may encounter the following error messages, which are easily resolved:

*Sub or Function not defined* - This error message is often the result of not having *WBA.XLA* checked as an available reference. Checking it as a reference makes the *What'sBest!* procedures available to your Visual Basic® code. Instructions for setting this reference are provided at the beginning of this section.

*Invalid outside procedure* - This message is often the result of using parenthesis without the *CALL* keyword. Either put the keyword *CALL* in front of procedure calls where you use parenthesis or remove the parenthesis.

---

## ***Beyond VBA / VB***

Model developers may prefer the ability to provide the user with a more elaborate, polished interface than can be provided using Excel® workbooks running Visual Basic® macros. Developers can create such applications using the full featured development environments of Visual Basic® or Microsoft® Access® that run *What'sBest!* with Excel® running in the background. The Access® or VB application can easily prepare the data for the optimization model, insert it into an Excel® workbook, and run *What'sBest!*, so that Excel® is completely hidden from the user.

The development of the application can progress in natural stages. The optimization model can first be prototyped and tested in Excel®. Once the structure of the model is decided upon, Visual Basic® code can be written to automate the process of creating the model within Excel®. Finally, the code can be incorporated into an Access® or Visual Basic® project in which the *What'sBest!* model is built based upon a data set provided by the application.

## *Embedding What'sBest! in a Visual Basic® / Visual Studio® Project*

We again return to the XYZ Tutorial problem to look at how it could be incorporated into a Visual Basic® (VB) program. Assuming that Visual Basic® is installed on the computer, extract the `WB_VB` project from the `WB_VB.zip` file of the *WB* directory. Start the Visual Basic® or Visual Studio® and

---

choose *File|Open Project* to select the "WB\_VB.sln" project. There are WB\_Module1.vb, WB\_Form1.vb, WB\_Form1.vb[Design], and the WB\_VB project properties.

This sample project will demonstrate a basic dialog box with a button. A function WB\_VBBuildXYZ() will actually open Microsoft Excel®, initialize the link to the *What'sBest!* add-in, and open the file C:\WB\XYZ.XLSX. It will then complete the model by setting the Adjustable, Best, and Constraint cells, then solves it. The solution will be displayed back onto the worksheet, with a message box for the returned status. The user can then close the messages.

The code clarify the basics for opening, building, and solving a model. The user can look at this project as a template for further developments, eventually adjusting on the platform, .NET, either 32 or 64-bit.

## *Concealing and Protecting a Model from the User*

*What'sBest!* allows model developers to hide aspects of a model that might be proprietary and protect sections of a model from inadvertent or unauthorized modification, while allowing the user to access and modify input data. While this does not require the use of Visual Basic®, these techniques can easily be used in conjunction with VBA.

Information in a *What'sBest!* model that is to be hidden from the user must reside on one or more worksheets that are separate from the worksheet(s) to which the user has access. Similarly, information that is to be protected must reside on one or more worksheets that are separate from the rest of the model.

To demonstrate how to conceal and protect a model from the user, we will modify the Product Mix model. First, we rename the *Prodmix* sheet as *Model*. Second, we will create two new worksheets that have all the information that the user needs: one called *Inputs* and the other called *Outputs*. When we are done, the *Model* sheet will be entirely hidden and protected from the user. It will contain data and formulas that are considered proprietary.

We now populate the *Inputs* and *Outputs* sheets as follows. First, we copy all of the data from A5:G6 on the *Model* sheet to the *Inputs* sheet. We now set the *Profit/ Unit* for each of the products to unlocked cells on this *Inputs* sheet. We can then protect the *Inputs* sheet with the *Tools|Protect Sheet* command and enter a password.

Turning to the *Outputs* sheet, we copy and change the "Quantity to Produce" for each of the products to formulas that reference the *Model* sheet. We can then protect the *Outputs* sheet from the user, so nothing can be changed. First, select the "Quantity to Produce" cells and choose *Format|Cells*. On the Protection tab, select *Hidden* (leave the cells *Locked*), so that the user can not see the formulas in these cells. Then, choose *Tools|Protection|Protect Sheet* and enter a password.

On the *Model* sheet, we change the "Profit/ Unit" for each of the products to formulas that reference the *Inputs* sheet.

The last thing to do is to hide and protect the *Model* sheet. To do this select the entire worksheet and choose *Format|Cells*. On the *Protection* tab select *Hidden*. Then, with the entire spreadsheet still selected, choose *Format|Row|Hide* and *Format|Column|Hide*. Next, protect the sheet by giving the

---

command *Tools|Protection|Protect Sheet* and enter a password. The final step is to hide the *Model* sheet with the command *Format|Sheet|Hide*.

Now, the user will only see the *Inputs* and *Outputs* sheets. A clever user would be able to determine that there is a *Model* sheet but he or she would not be able to view or modify it. In the *WB* subdirectory, there is a file called *PRODMIX2.XLS*, which has the changes described above.

**Note:** It is not possible to use Excel®'s *Tools|Protection|Protect Structure* command with *What'sBest!*. This command does not allow the *WB! Status* or *WB! Solution* worksheets to be added to the workbook.

## Tutorial on the VBA Interface

This section provides a tutorial on the basics of running *What'sBest!* commands using VBA (Visual Basic® for Applications). It includes detailed discussion and step-by-step examples of a variety of different common applications combining Visual Basic® and *What'sBest!*.

**Note:** The first step in running any *What'sBest!* from VBA is to create a reference to *What'sBest!*. This reference is made by checking the *WBA.XLA* box under *Tools|References* from within the *Visual Basic® Editor* (The *Visual Basic® Editor* is called via *Tools|Macros* from the main Excel® menu bar). If you do not create this reference, then any attempt to use the *What'sBest!* attributes or procedures will produce the error message *Sub or Function not defined*.

## Building and Solving a Basic Model

Let's revisit the *XYZ Production* problem discussed in the *Tutorial of Getting Starting*. We will look at how the *ABC's* of a model can be specified using Visual Basic®. Unless specified otherwise, a sample file named *XYZVBA.XLSM* was copied to the *WB* subdirectory during installation. Along with the main *XYZ* worksheet, there are two VBA modules called *ABC's* and *Dual*.

The *ABC's* module has three procedures in it: *BuildXYZ*, which uses Visual Basic® to build and solve the model; *MaxDeluxe*, which changes the objective to maximizing the use of *Deluxe* computer towers and solves the new model; and *MaxDeluxe2*, which uses the same objective as *MaxDeluxe*, but imposes a restriction that profit must be greater-than-or-equal-to \$32,000. You will notice that the code to build the model is very straightforward. For information on the complete syntax for each of the functions, refer to the section on *Procedures*.

The *BuildXYZ* procedure is listed below:

```
Sub BuildXYZ ()

    Dim lngSolutionStatus As Long

    'Go to line label Handler for code that handles error
    On Error GoTo Handler

    'Make Quantities to Produce (C5:D5) Adjustable
```

```
wbAdjust "C5:D5"

'Make Total Profit (G6) the best cell to Maximize
wbBest "G6", "Maximize"

'Constrain Total Usage (E15:E17) to be less than Number in
'Stock (G15:G17)
wbConstraint "E15:E17", "<=", "G15:G17", "F15:F17"

'Solve the model
wbSolve lngSolutionStatus

'Display the results
Select Case lngSolutionStatus
    Case 1
        MsgBox "The model is: Globally Optimal"
    Case 2
        MsgBox "The model is: Globally Optimal, " & _
            Range("WBMAX")
    Case 3
        MsgBox "The model is: Infeasible"
    Case 4
        MsgBox "The model is: Unbounded"
    Case 5
        MsgBox "The model is: Feasible"
    Case 6
        MsgBox "The model is: Infeasible or Unbounded"
    Case 7
        MsgBox "The model is: Near Optimal"
    Case 8
        MsgBox "The model is: Locally Optimal"
    Case 9
        MsgBox "The model is: Locally Infeasible"
    Case 10
        MsgBox "The model is: Cutoff"
    Case 11
        MsgBox "The model is: Numerical Error"
    Case 12
        MsgBox "The model is: Unknown"
    Case 13
        MsgBox "The model is: Unloaded"
    Case 14
        MsgBox "The model is: Loaded"
    Case Else
        MsgBox "Solution status unknown"
End Select

Exit Sub
```

---

```

Handler:
    MsgBox "The error description is " & wbError(Err)

End Sub

```

In the above example, any line starting with a single quotation mark is a comment.

**Note:** If Excel® returns the error message *Sub or Function not defined*, then *What'sBest!* needs to be set as an available reference. To do this, choose *Tools|References* from the Visual Basic® Editor and check *WBA.XLA* in the list. Now, you should be able to run the procedure without error.

The procedure *BuildXYZ* shown above is very simple. It sets C5:D5 to be adjustable cells, makes the *Total Profit* in G6 the cell to maximize, and constrains *Total Usage* (E15:E17) to be less than the *number in stock* (G15:G17). When these steps have been performed, the macro code solves the model and displays the results.

To make this example more readable, the ranges passed to the *What'sBest!* procedures are text references. Alternately, the ranges could also have been passed as objects to allow the developer to work with row and column numbers instead of the text. The above code presented with object references would look like this:

```

'Make Quantities to Produce (C5:D5) Adjustable
wbAdjust Range(Cells(5,3), Cells(5,4))

'Make Total Profit (G6) the best cell to Maximize
wbBest Cells(6,7), "Maximize"

'Constrain Total Usage (E15:E17) to be less than Number in
'Stock (G15:G17)
wbConstraint Range(Cells(15,5), Cells(17,5)), "<=", _
    Range(Cells(15,7), Cells(17,7)), Range(Cells(15,6), _
    Cells(17,6))

```

The two other procedures in the *ABC's* module, *MaxDeluxe* and *MaxDeluxe2*, simply change the XYZ model slightly and solve it again. The *Dual* module contains a couple of subroutines that demonstrate putting dual value functions in the model.

In the examples above, none of the arguments used the named argument syntax. To do so, simply list the argument name followed by a colon and equal sign and then the argument. To set the range C5:D5 as adjustable with the named argument syntax, enter:

```
wbAdjust AdjRange:="C5:D5", AdjChoice:="Adjustable"
```

Using the named argument syntax can make the code easier to read and, when calling procedures with multiple arguments, allows you to list the arguments in any order you choose.

## Solving Multiple Problems with a Looping Macro

When automating a process using macros, you may want to run the same macro many times on different data while storing the optimal solution for each data set. For example, you may have a database filled with information on the return on a group of investments at a range of interest rates. What's *Best!* can be used to determine the optimal portfolio in each situation by using a looping macro. Using the *PMIXMAC.XLS* sample file, which was copied to the *WB* subdirectory during installation, let's look at how a looping macro might be created. Use the Visual Basic® Editor to go to the *Looping Macro* module in your workbook and your screen should look like the following:

```
Sub Macroloop()

    'This macro will increment the Profit/Unit of Product 2
    'from 45-60, solve the model, copy the Total Profit and Quantity Produced
    'of Products 1-6 to a table, and repeat.

    Dim Count As Integer
    Dim TableRow As Integer

    'Initialize the profit of product 2 to 45
    Sheets("PRODMIX").Select
    Range("C6") = 44

    'Evaluate the effect of changing the profit on product 2 by
    'increasing it by one unit and resolving. Solve the model,
    'save the results in a table, and increment the profit on
    'product 2.

    For Count = 1 To 20

        'Copy a new value to the profit of product 2
        Range("C6") = Range("C6") + 1
        'Solve the current model
        Application.Run macro:="WBUsers.wbSolve"
        'Set TableRow to Count plus 2, since the table will
        'start in row 3
        TableRow = Count + 2
        'Copy the profit per unit for product 2 to the table
        Sheets("PRODMIX").Select
        Cells(TableRow, 12) = Range("C6")
        'Copy the solution so it can be pasted into the table
        Range("B8:G8").Copy
        'Paste the solution to the table. We paste in the values
        'only to prevent the cells.
        'in the table from being treated as Adjustable
        Range(Cells(TableRow, 13), Cells(TableRow, 18)).PasteSpecial Paste:=xlValues
        'Save the Total Profit in the table
        Cells(TableRow, 19) = Range("A3")

    Next Count

End Sub
```

Lines beginning with a single quotation mark are comments.



The macro shown here performs range analysis by incrementing the profit/unit of product 2 from 45 to 64. The *For...Next* form of looping in Visual Basic® is used here, but other looping forms such as *Do...Loop* and *For Each...Next* forms are available. Please consult the Visual Basic® or Excel® Help for more information.

After running the macro, the adjustable cells and the best cell for each increment are copied to the table in the range L2:S22. The row is incremented each time through the variable *Table* that is always two greater than the *Count* (the iteration number). In this way, a convenient report is created providing sensitivity analysis of the profit/unit of Product 2.

As shown here, there are changes in the optimal solution when the profit/unit for product 2 is \$50 or greater. In addition to simply having the macro increment the profit/unit for product 2 through a range, the profit/unit values could have been read from a database or a text file.

This model is a looping version of the *Product Mix* model.

---

## VBA Interface: Procedures

What'sBest! provides a set of Visual Basic® Procedures that allow models to be built and automated using Visual Basic® for Applications (VBA) commands. These procedures are the same ones that are called when What'sBest! commands are selected from the *WB!* menu or the What'sBest! toolbar. For example, the *Solve* procedure invoked in a macro is also invoked when you press the  button on the What'sBest! toolbar.

If you wish to automate the creation of a What'sBest! model, or if you wish to incorporate What'sBest! as a part of a larger application, then you will find these procedures to be invaluable. They make it relatively easy to incorporate What'sBest! into a Microsoft® Excel® or Access® application, or any other application offering Visual Basic® for Applications.

All of the following procedures with arguments requiring cells can accept either range objects or the address of the cell(s).

---

**Note:** VBA is case-insensitive to the procedure name when it is called, so any procedure could alternately be called with its name typed entirely in lower case (i.e., as "wbaddadjustablestyle" instead of "wbAddAdjustableStyle").

---

All of the What'sBest! procedures available are listed below with details on their syntax, arguments, error codes, and any return values. Some also include examples of using the procedure or remarks. The procedures with arguments that require cells can accept either range objects or the address of the cell(s). Argument with square brackets ([ and ]) around them are optional - non-bracketed arguments are required.

---

### ***wbAddAdjustableStyle***

This routine is used to add the adjustable style to a workbook that does not have one yet.

Syntax: `wbAddAdjustableStyle()`

The `wbAddAdjustableStyle` procedure has no arguments.

<b><i>Error Codes</i></b>	<b><i>Description</i></b>
<i>Adj_CreateStyleError</i>	Error Creating an Adjustable style

Remarks: Because this procedure is called by the `wbAdjust` procedure, in most cases, it should not be necessary for the developer to call it directly.

---

### ***wbAddBestStyle***

This routine is used to add the best style to a workbook that does not have one yet.

Syntax: `wbAddBestStyle()`

The `wbAddBestStyle` procedure has no arguments.

<b><i>Error Codes</i></b>	<b><i>Description</i></b>
<i>Best_CreateStyleError</i>	Error Creating a Best style

Remarks: Only one cell, the objective cell, should use this style.

---

### ***wbAddWBMenu***

This routine is used to add the *WB!* menu item to the Excel® menu.

Syntax: `wbAddWBMenu()`

The `wbAddWBMenu` procedure has no arguments.

<b><i>Error Code</i></b>	<b><i>Description</i></b>
<i>AddWBMenuError</i>	Error in adding the <i>WB!</i> menu

Remarks: This procedure and the `wbDeleteWBMenu` procedure allows a developer to remove and add the *WB!* menu as desired.

---

## ***wbAdjust***

For additional discussion of the functionality provided, see the section entitled *Adjustable*, which refers to the dialog box interface that calls this procedure.

This routine is also called with appropriate arguments by two of the toolbar buttons.

This routine is used to either set cells as adjustable or to remove the adjustable attribute. All arguments are optional.

**Syntax:** `wbAdjust([AdjRange], [AdjChoice], [NoErrDialog])`

<b>Argument</b>	<b>Required</b>	<b>Description</b>
<i>AdjRange</i>	No	This is the range or address of the cells to be rendered adjustable. If omitted, the default value for <i>AdjRange</i> is the current selection.
<i>AdjChoice</i>	No	This is a string to indicate <i>Adjustable</i> or <i>Reset</i> . <i>AdjChoice</i> accepts the text "Adjust" to set the <i>AdjRange</i> as Adjustable or "Reset" to set the <i>AdjRange</i> to no longer be adjustable. If omitted, the default value for <i>AdjChoice</i> is "Adjust". For backwards compatibility with earlier versions of <i>What'sBest!</i> , <i>AdjChoice</i> also accepts the numbers 1 for <i>Adjustable</i> and 2 for <i>Reset</i> .
<i>NoErrDialog</i>	No	Any argument passed here causes all <i>What'sBest!</i> error dialog boxes from the <i>wbAdjust</i> routine to be suppressed. Instead, the error number is delivered in this return argument. Pass an integer to use any possible returned <i>What'sBest!</i> error number. Useful in an embedded application of <i>What'sBest!</i> .

<b>Error Codes</b>	<b>Description</b>
<i>Adj_BadAdjRangeArg</i>	Bad <i>AdjRange</i> argument
<i>Adj_BadAdjChoiceArg</i>	Bad <i>AdjChoice</i> argument
<i>Adj_ProtectedSheetError</i>	Unable to set cells as adjustable on a protected sheet
<i>Adj_CreateStyleError</i>	Error creating an <i>Adjustable</i> style
<i>Adj_CheckStyleUnlockedError</i>	Error checking that the <i>Adjustable</i> style is unlocked
<i>Adj_CheckStyleProtectionError</i>	Error checking that the <i>Adjustable</i> style includes protection

**Remarks:** An adjustable cell must contain a number or the cell is ignored by the solver. The *Adjust* procedure formats the cell(s) with a style called *Adjustable*, which carries a blue font color as a visual reminder. All adjustable cells will return non-negative values unless they are in a *WBFREE* range.

**Example:** To set the cells D8:E10 as adjustable, enter the macro

```
wbAdjust "D8:E10"
```

or

```
wbAdjust Range(Cells(8,4),cells(10,5))
```

To reset the cells D8:D10 to no longer be adjustable, enter:

```
wbAdjust "D8:D10", "Reset"
```

or

```
wbAdjust Range(Cells(8,4), cells(10,4)), "Reset"
```

## ***wbBest***

For additional discussion of the functionality provided, see the section entitled *Best*, which refers to the dialog box that calls this procedure.

This routine is also called with appropriate arguments by the either of the toolbar buttons displayed above.

This routine is used to create a best cell, replacing any previously defined best cell. All arguments are optional.

Syntax: `wbBest([BestCell], [BestChoice], [NoErrDialog])`

<b><i>Argument</i></b>	<b><i>Required</i></b>	<b><i>Description</i></b>
<i>BestCell</i>	No	This is the cell or address of the cell to be the best cell. If omitted, the default value for <i>BestCell</i> is the current cell.
<i>BestChoice</i>	No	This is a string to indicate whether the best cell should be minimized or maximized. <i>BestChoice</i> accepts "MIN" or "MINIMIZE" (upper or lower case) for minimize, "MAX" or "MAXIMIZE" (upper or lower case) for maximize, and "NONE" (upper or lower case) to remove any previous best cell. If omitted, the default value for <i>BestChoice</i> is minimize. For backwards compatibility with earlier versions of <i>What'sBest!</i> , <i>BestChoice</i> also accepts the numbers 1 for <i>Minimize</i> , 2 for <i>Maximize</i> , and 3 for <i>None</i> .
<i>NoErrDialog</i>	No	Any argument passed here causes all <i>What'sBest!</i> error dialog boxes from the <i>wbBest</i> routine to be suppressed. Instead, the error number is delivered in this return argument. Pass an integer to get any possible returned <i>What'sBest!</i> error number. Useful in an embedded application of <i>What'sBest!</i> .

<b>Error Codes</b>	<b>Description</b>
<i>Best_BadBestCellArg</i>	Bad <i>BestCell</i> argument
<i>Best_BadBestChoiceArg</i>	Bad <i>BestChoice</i> argument
<i>Best_ProtectedSheetError</i>	Unable to set the best cell in a protected sheet
<i>Best_CreateStyleError</i>	Error creating a <i>Best</i> style

**Remarks:** Only one cell can be specified as a best cell.

**Example:** To set I17 as your objective to minimize, enter:

```
wbBest "I17", "Minimize"
```

To set F17 as the objective to maximize, enter:

```
wbBest "F17", "Maximize"
```

To reset cell F17 to “None”, enter:

```
wbBest "F17", "None"
```

---

## **WBBIN**

For additional discussion of the functionality provided, see the section entitled *Integer*, which refers to the *Binary* option button that calls this procedure.

This routine is used to build binary integer ranges named *WBBIN*. The adjustable cells contained in these ranges will be set to either 0 or 1 by the *What'sBest!* solver.

**Syntax:** WBBIN(IntName, [Refers\_to])

<b>Argument</b>	<b>Required</b>	<b>Description</b>
<i>IntName</i>	Yes	<i>IntName</i> is a string that refers to the range being made integer.
<i>Refers_to</i>	No	<i>Refers_to</i> is the range or address of the cells to be specified as integer. If omitted, the default is the current selection.

<b>Error Codes</b>	<b>Description</b>
<i>Int_BadIntNameArg</i>	Bad <i>IntName</i> argument
<i>Int_BadRefers_toArg</i>	Bad <i>Refers_to</i> argument
<i>Int_ProtectedSheetError</i>	Unable to set integer cells on a protected sheet
<i>Int_CreateError</i>	Error setting integer cells

**Remarks:** Integer variables can dramatically increase total solution times.

---

Example:

To constrain cell F7 to be a binary integer using the range name OnOff, enter:

```
WBBIN "OnOff", "F7"
```

To Remove:

If you wish to delete a *WBBIN* range name using VBA instead of the *Delete* button on the *Integer-Binary* dialog box, you can use:

```
ActiveWorkbook.Names("WBBINOnOff").Delete.
```

This statement removes the *WBBIN* range name, thereby returning the adjustable cells contained in the former range to normal status.

**wbConstraint**

For additional discussion of the functionality provided, see the section entitled *Constraints*, which refers to the dialog box that calls this procedure.

This routine is also called with appropriate arguments by the three toolbar buttons displayed above.

This routine inserts a constraint formula within the selected cell.

Syntax : wbConstraint(LHS, Direction, RHS, ConLoc, [NoErrDialog])

<b>Argument</b>	<b>Required</b>	<b>Description</b>
<i>LHS</i>	Yes	<i>LHS</i> is the left-hand side of the constraint equation.
<i>Direction</i>	Yes	This is a string to indicate what type of constraint: "<=" (less-than-or-equal-to), ">=" (greater-than-or-equal-to), "=" (equal-to), "<c=" (convex), ">c=" (concave), or "=c" (convex). For backward compatibility with earlier versions of <i>What'sBest!</i> , <i>Direction</i> also accepts the numbers 1 for "<=", 2 for "=", and 3 for ">=", 4 for "<c=", 5 for "=c", 6 for ">c=", 7 for "None".
<i>RHS</i>	Yes	<i>RHS</i> is the right-hand side of the constraint equation. It can be a range or a value (see the <i>Remarks</i> below).
<i>ConLoc</i>	Yes	<i>ConLoc</i> is the range to store the constraints.
<i>NoErrDialog</i>	No	Any argument passed causes all <i>What'sBest!</i> error dialog boxes from the <i>wbConstraint</i> routine to be suppressed. Instead, the error number is delivered in this return argument. Pass an integer to get any possible returned <i>What'sBest!</i> error number. Useful in an embedded application of <i>What'sBest!</i> .

<b>Error Codes</b>	<b>Description</b>
<i>Con_BadLHSArg</i>	Bad <i>LHS</i> argument
<i>Con_BadDirectionArg</i>	Bad <i>Direction</i> argument

<i>Con_BadRHSArg</i>	Bad <i>RHS</i> argument
<i>Con_BadConLocArg</i>	Bad <i>ConLoc</i> argument
<i>Con_RangeSizeError</i>	LHS must be same size as <i>ConLoc</i>
<i>Con_ProtectedSheetError</i>	Unable to enter constraints on a protected sheet

Remarks: LHS and *ConLoc* ranges must be the same size.

RHS can be a range or a value.

Example: To enter the constraint H8 >= 10 into cell I8, enter:

```
wbConstraint "H8", ">=", "10", "I8"
```

or

```
wbConstraint Cells(8,8), ">=", "10", Cells(8,9)
```

To constrain H8:H10 to be less-than-or-equal-to J8:J10 and store the constraints in I8:I10, enter:

```
wbConstraint "H8:H10", "<=", "J8:J10", "I8:I10"
```

or

```
wbConstraint Range(Cells(8,8),Cells(10,8)), "<=", _  
Range(Cells(8,10),Cells(10,10)), _  
Range(Cells(8,9),Cells(10,9))
```

### ***wbConstraintPOSD***

For additional discussion of the functionality provided, see the section entitled *Constraints...*, which refers to the dialog box that calls this procedure.

This routine is also called with appropriate arguments by the three toolbar buttons displayed above.

This routine inserts a constraint formula within the selected cell.

Syntax: *wbConstraintPOSD*(RangeMatrix, Place\_in\_cell, [NoErrDialog])

<b><i>Argument</i></b>	<b><i>Required</i></b>	<b><i>Description</i></b>
RangeMatrix	Yes	RangeMatrix is a cell reference for indicating the range of the matrix.
Place_in_cell	Yes	Place_in_cell is a cell reference to specify the cell in which to write the WBPOSD function.
NoErrDialog	No	Any argument passed causes all <i>What'sBest!</i> error dialog boxes from the <i>wbConstraintPOSD</i> routine to be suppressed. Instead, the error number is delivered in this return argument. Pass an integer to get any possible returned <i>What'sBest!</i> error number. Useful in an embedded application of <i>What'sBest!</i> .

<b>Error Codes Value</b>	<b>Description</b>
Con_BadRangeMatrixArg	Bad RangeMatrix argument
Con_BadPlaceInCellArg	Bad PlaceInCell argument

**Remarks:**

*RangeMatrix* ranges must be a symmetric range, more than one cell.

Example:

To enter the POSD constraint for the matrix A1:C3, and the function =WBPOSD() in cell D1, enter:

```
wbConstraintPOSD "A1:C3", "D1"
```

or

```
wbConstraintPOSD Range(Cells(1,1),Cells(3,3)), Cells(1,4)
```

**wbDeleteReports**

This routine is called by the *Delete Reports* button on the *General Options* dialog box posted by the *Options...|General* command.

This routine is used to delete any What'sBest! report worksheets (*WB! Status* and *WB! Solution*) in the current workbook.

**Syntax:** `wbDeleteReports()`

The *wbDeleteReports* procedure has no arguments.

<b>Error Codes Value</b>	<b>Description</b>
<i>Rep_DeleteReportsError</i>	Error deleting one of the reports

**wbDeleteWBMenu**

This routine is used to delete the *WB!* menu item from Excel®'s menu.

**Syntax:** `wbDeleteWBMenu()`

The *wbDeleteWBMenu* procedure has no arguments.

**Remarks:** This procedure, together with the *wbAddWBMenu* procedure, allows a developer to remove and add the *WB!* menu as desired.



## ***wbDualValue***

For additional discussion of the functionality provided, see the section entitled *Advanced...|Dual*, which refers to the dialog box interface that calls this procedure.

This routine is used to build the dual formulas. All arguments are optional.

**Syntax:** `wbDualValue([DualCells], [DualLoc], [DualChoice])`

<b>Argument</b>	<b>Required</b>	<b>Description</b>
<i>DualCells</i>	No	<i>DualCells</i> is the range or cell that dual value information is desired for. If omitted, the default is the offset of one cell to the left of the current selection.
<i>DualLoc</i>	No	<i>DualLoc</i> is the range or cell where the information is to be displayed. If omitted, the default is the current selection.
<i>DualChoice</i>	No	<i>DualChoice</i> is a string indicating the type of information desired. <i>Dual</i> or <i>Dual Value</i> for dual value, <i>Upper</i> or <i>Upper Range</i> for upper range, and <i>Lower</i> or <i>Lower Range</i> for lower range. If omitted, the default is <i>Dual</i> . For backwards compatibility with earlier versions of <i>What'sBest!</i> , <i>DualChoice</i> also accepts the numbers 1 for <i>Dual</i> , 2 for <i>Lower</i> , and 3 for <i>Upper</i> .

<b>Error Codes</b>	<b>Description</b>
<i>Dual_BadDualsCellArg</i>	Bad <i>DualCells</i> argument
<i>Dual_BadDualLocArg</i>	Bad <i>DualLoc</i> argument
<i>Dual_BadDualChoice</i>	Bad <i>DualChoice</i> argument
<i>Dual_ProtectedSheetError</i>	Unable to enter dual formulas on a protected sheet

**Remarks:** On integer models, dual value information is only of limited use.

**Example:** To create the dual value for cell E5 in cell F5, enter:

```
wbDualValue "E5", "F5", "Dual Value"
```

To create the upper and lower ranges for cell E5 displayed in cells F6 and F7, respectively, enter:

```
wbDualValue "E5", "F6", "Upper Range"
wbDualValue "E5", "F7", "Lower Range"
```

## ***wbError, and Error Codes***

It is very important to handle any possible *What'sBest!* errors using some form of the On Error statement as shown in the code example below when error-handling code is in place. If a *What'sBest!* VBA procedure encounters an error, then your code handles the particular error. For example, you can obtain a description of the error and provide it to the user, or perhaps provide the user with further information, as the code example below demonstrates. However, if your code that calls the *What'sBest!* procedure does not have error-handling, then Excel® handles any *What'sBest!* error with a run-time error message that can sometimes disguise the error. For details, see the section entitled *Run-time Errors*.

Code Sample One (below) sets the selected cell(s) as adjustable and solves the model, while providing the user with information in case there is an error setting adjustable cells on a protected sheet. The code also displays a description of any other error.

NOTE ON CODE SAMPLE ONE: *What'sBest!* has defined error numbers beginning at 30001. These error numbers should not be used in your code, since they are subject to change. Instead, use the error codes stored in the `wbErr` structure, as shown in the example below. *What'sBest!* provides a function to return the error text for these `wbErr` codes. This function is similar to Excel®'s `Error()` function. The `wbError()` function takes an error code or error number as an argument and returns the error text.

' CODE SAMPLE ONE

```
Sub mySub
On Error GoTo ErrorHandler          'Trap any What'sBest!
error

wbAdjust                            'Make current cell
adjustable

wbSolve                             'Solve the model

Exit Sub

ErrorHandler:                       'Process any
What'sBest! error

If (Err = wbErr.Adj_ProtectedSheetError) Then
MsgBox "To the user: Please unprotect all the sheets in your models
using the Tools|Protect command"
Else
If Err >= 30000 Then
MsgBox "The error description is " & _
wbError(Err)
Else
MsgBox "The error description is " & _
Err.Description
```

```
End If
End If
Exit Sub
End Sub
```

If you are running *What'sBest!* within a VB project, you should use an alternative method for error handling. This method will prevent possible *What'sBest!* errors from being transformed into unusable Visual Basic® runtime errors. The following *Code Sample Two* can be used as a workaround for the Visual Basic® project file `WB_VB.sln`, available in the *WB* directory.

#### ' CODE SAMPLE TWO

```
Sub VBABuildXYZ
    {Omitted code that created an Excel® object named gobjExcel and
    opens the problem to be solved}
    Dim intError As Integer
    gobjExcel.Run "wbAdjust", "C5:D5", , intError
    If (intError > 0) Then
        GoTo Quit
    End If
    {Omitted code similar to above for wbBest, wbConstraint, and
    wbSolve, as well as code for displaying the results of solve}
    Exit Sub
Quit:
    Dim strError as String
    gobjExcel.Run "wbError", intError, strError
    MsgBox "Error # = " & intError & ", Description: " & _
        strError
    Exit Sub
End Sub
```

---

***wbError***

The error numbers and the codes stored in the `wbErr` structure are as follows:

<b>Number</b>	<b>Code</b>
30001	Adj_BadAdjRangeArg
30002	Adj_BadAdjChoiceArg
30003	Adj_ProtectedSheetError
30004	Adj_CreateStyleError
30005	Adj_CheckStyleUnlockedError
30006	Adj_CheckStyleProtectionError
30007	Free_BadRefers_toArg
30008	Free_ProtectedSheetError
30009	Free_CreateError
30010	Best_BadBestCellArg
30011	Best_BadBestChoiceArg
30012	Best_ProtectedSheetError
30013	Best_CreateStyleError
30020	Con_BadLHSArg
30021	Con_BadDirectionArg
30022	Con_BadRHSArg
30023	Con_BadConLocArg
30024	Con_RangeSizeError
30025	Con_ProtectedSheetError
30026	Con_BadRangeMatrixArg
30027	Con_BadPlaceInCellArg
30030	Solve_UnmappedDrive
30031	Solve_NoDLL

---

30032	Solve_BadSolutionStatusArg
30033	Solve_BadExcelOpenArg
30034	Solve_MultipleMaxMinError
30035	Solve_ProtectedWorkBookError
30036	Solve_ReadLINDOWBRCErr
30037	Solve_SaveTempFileError
30038	Solve_MinimumFileFormatError
30039	Solve_UnableToLoadSolverError
30040	Solve_ErrorRunningSolver
30050	IntSemic_BadLowerBoundArg
30051	IntSemic_BadUpperBoundArg
30052	IntSemic_BadArgListArg
30053	IntSemic_BadRefersToArg
30054	IntSemic_ProtectedSheetError
30060	IntCard_BadCardNumberArg
30061	IntSos_BadTypeSosArg
30062	IntSos_BadArgListArg
30063	IntSos_BadRefersToArg
30064	IntSos_ProtectedSheetError
30070	Int_BadRefers_toArg
30071	Int_BadIntChoiceArg
30072	Int_ProtectedSheetError
30073	Int_CreateError
30080	Opt_BadFeasibilityToleranceArg
30081	Opt_BadIterLimitArg
30082	Opt_BadRuntimeLimitArg
30083	Opt_BadNumberThreadsLimitArg
30084	Opt_BadThreadChoiceArg
30085	Opt_BadSelectRefersToArg
30086	Opt_BadMinimizeExcelArg

---

30087	Opt_BadHideStatusArg
30088	Opt_BadConstraintIndSlackArg
30089	Opt_BadLinearizationDegArg
30090	Opt_BadDeltaCoeffArg
30091	Opt_BadBigMCoeffArg
30092	Opt_BadStatusReportArg
30093	Opt_BadReportsLocationArg
30094	Opt_BadSolutionReportArg
30095	Opt_BadNonlinearityArg
30096	Opt_BadNoObjectiveArg
30097	Opt_BadBlankCellsArg
30098	Opt_BadUnsupportedFunctionArg
30099	Opt_BadStringArgumentArg
30100	Opt_BadIrreConstraintArg
30101	Opt_BadInfeasConstraintArg
30102	Opt_BadUnboundVarArg
30103	Opt_BadSupLookupFctArg
30104	Opt_BadEditLinksArg
30110	LinOpt_BadScaleModelArg
30111	LinOpt_BadReductionArg
30112	LinOpt_BadLinearSolverMethodArg
30113	LinOpt_BadDualPricingArg
30114	LinOpt_BadPrimalPricingArg
30120	NonlinOpt_BadStratCrashInitialArg
30121	NonlinOpt_BadStartUseLINDOCrashArg
30122	NonlinOpt_BadStratSLPDirectionArg
30123	NonlinOpt_BadStratSLPSolverArg
30124	NonlinOpt_BadStratQuadraticRecognitionArg
30125	NonlinOpt_BadStratPresolveArg
30126	NonlinOpt_BadStratSelectiveConstraintArg

---

30127	NonlinOpt_BadStratSteepestEdgeArg
30128	NonlinOpt_BadStartingPointArg
30129	NonlinOpt_BadOptimalityToleranceArg
30130	NonlinOpt_BadItLimitSlowProgArg
30131	NonlinOpt_BadDerivativesArg
30140	GlobalOpt_BadGIStratGlobalArg
30141	GlobalOpt_BadGIMultistartAttemptsArg
30142	GlobalOpt_BadGIOptimalityToleranceArg
30143	GlobalOpt_BadGIDeltaToleranceArg
30144	GlobalOpt_BadGIVariableBoundLimitArg
30145	GlobalOpt_BadGIUseBoundLimitArg
30146	GlobalOpt_BadGIBranchingDirectionArg
30147	GlobalOpt_BadGIBoxSelectionArg
30148	GlobalOpt_BadGIALgebraicReformulationArg
30150	IntPreSolvOpt_BadHeuristicLevelArg
30151	IntPreSolvOpt_BadCutoffCriterionArg
30152	IntPreSolvOpt_BadProbingLevelArg
30153	IntPreSolvOpt_BadMaxCutsPassesArg
30154	IntPreSolvOpt_BadRelativeCutsLimitArg
30155	IntPreSolvOpt_BadCoefficientReductionCutsArg
30156	IntPreSolvOpt_BadDisaggregationCutsArg
30157	IntPreSolvOpt_BadFlowCoverCutsArg
30158	IntPreSolvOpt_BadGCDCutsArg
30159	IntPreSolvOpt_BadGomoryCutsArg
30160	IntPreSolvOpt_BadGUBCutsArg
30161	IntPreSolvOpt_BadKnapsackCoverCutsArg
30162	IntPreSolvOpt_BadLatticeCutsArg
30163	IntPreSolvOpt_BadLiftingCutsArg
30164	IntPreSolvOpt_BadPlantLocationCutsArg
30165	IntPreSolvOpt_BadObjIntegralityCutsArg

---

30166	IntPreSolvOpt_BadBasicCutsArg
30167	IntPreSolvOpt_BadCardinalityCutsArg
30168	IntPreSolvOpt_BadDisjunctiveCutsArg
30170	IntOpt_BadBranchingDirectionArg
30171	IntOpt_BadAbsoluteIntegralityArg
30172	IntOpt_BadRelativeIntegralityArg
30173	IntOpt_BadWarmStartArg
30174	IntOpt_BadColdStartArg
30175	IntOpt_BadAbsoluteOptimalityArg
30176	IntOpt_BadRelativeOptimalityArg
30177	IntOpt_BadTimeToRelativeArg
30178	IntOpt_BadHurdleArg
30179	IntOpt_BadNodeSelectionArg
30180	IntOpt_BadStrongBranchArg
30181	IntOpt_BadKBestArg
30182	IntOpt_BadKBestReportArg
30183	IntOpt_BadBNPBlocksArg
30184	IntOpt_BadBNPHeuristicArg
30185	IKBest_BadArgListRepArg
30186	IKBest_BadRefersToRepArg
30187	IKBest_ProtectedSheetRepError
30190	StoOpt_BadAdvStochasticSupportArg
30191	StoOpt_BadAdvSimulationSupportArg
30192	StoOpt_BadFunctionNameArg
30193	StoOpt_BadRefersToArg
30194	StoOpt_BadPercentArg
30195	StoOpt_BadObjWeightArg
30196	StoOpt_BadStageArg
30197	StoOpt_BadCellRange1Arg
30198	StoOpt_BadCellRange2Arg

---



30199	StoOpt_BadCellRange3Arg
30200	StoOpt_BadPlaceInCellArg
30201	StoOpt_BadCellRange1CellRange2Arg
30202	StoOpt_BadCellRange1CellRange2CellRange3Arg
30203	StoOpt_BadRangeChoiceArg
30204	StoOpt_BadArgListArg
30205	StoOpt_BadNumberBinsArg
30206	StoOpt_ProtectedSheetRepError
30207	StoOpt_BadStochasticSolverMethodArg
30208	StoOpt_BadStochasticSeedArg
30209	StoOpt_BadStochasticSamplSizeArg
30210	StoOpt_BadStochasticSamplContArg
30211	StoOpt_BadStochasticEVWSArg
30212	StoOpt_BadStochasticEVEMArg
30213	StoOpt_BadStochasticEVPIArg
30214	StoOpt_BadStochasticEVMUArg
30215	StoOpt_BadStochasticRepScenHorizArg
30220	Dual_BadDualCellsArg
30221	Dual_BadDualLocArg
30222	Dual_BadDualChoiceArg
30223	Dual_ProtectedSheetError
30224	Omit_BadRefers_toArg
30225	Omit_ProtectedSheetError
30226	Omit_CreateError
30227	AdvFunc_BadAdvFunctionSupportArg
30228	AdvStr_BadAdvStringSupportArg
30229	AdvStr_BadAdvStringLengthArg
30230	Rep_DeleteReportsError
30231	Rep_FormatError
30232	Rep_OpenError

30233	UpdateLinksProtectedError
30234	UpdateLinksHiddenError
30235	CheckAdjustableStyleError
30236	Invalid_Data_Type
30237	CleanUpFilesError
30238	AddWBMenuError
30239	ResetOptionsToDefaultError

## **WBFREE**

For additional discussion of the functionality provided, see the section entitled *Free*, which refers to the dialog box that calls this procedure.

This routine builds *WBFREE* ranges, which are areas of the worksheet where adjustable cells are allowed to be negative.

Syntax: WBFREE(FreeName, [Refers\_to])

<b>Argument</b>	<b>Required</b>	<b>Description</b>
<i>FreeName</i>	Yes	<i>FreeName</i> is a string that refers to the range being allowed to be negative.
<i>Refers_to</i>	No	<i>Refers_to</i> is the range or address of the cells to be allowed to be negative. If omitted, the default is the current selection.

<b>Error Codes</b>	<b>Description</b>
<i>Free_BadRefers_toArg</i>	Bad <i>Refers_to</i> argument
<i>Free_ProtectedSheetError</i>	Unable to set free cells on a protected sheet
<i>Free_CreateError</i>	Error setting free cells

### Example:

To allow cell G8 to be positive or negative using the range name BuySell, enter:

```
WBFREE "BuySell", "G8"
```

### To Remove:

If you wish to delete a *WBFREE* range name using VBA instead of the *Delete* button on the *Free* dialog box, you can use:

```
ActiveWorkbook.Names("WBFREEBuySell").Delete.
```

This statement removes the *WBFREE* range name, thereby returning the adjustable cells contained in the former range to normal status.

## **WBINT**

For additional discussion of the functionality provided, see the section entitled *Integer*, which refers to the *Integer* dialog box having a *General* option button that calls this procedure.

This routine is used to build general integer ranges named *WBINT*. The adjustable cells contained in these ranges will be set to non-negative, integral values by the *What'sBest!* solver.

**Syntax:** WBINT(IntName, [Refers\_to])

<b>Argument</b>	<b>Required</b>	<b>Description</b>
<i>IntName</i>	Yes	<i>IntName</i> is a string that refers to the range being made integer.
<i>Refers_to</i>	No	<i>Refers_to</i> is the range or address of the cell(s) to be specified as integer. If omitted, the default is the current selection.

<b>Error Codes</b>	<b>Description</b>
<i>Int_BadIntNameArg</i>	Bad <i>IntName</i> argument
<i>Int_BadRefers_toArg</i>	Bad <i>Refers_to</i> argument
<i>Int_ProtectedSheetError</i>	Unable to set integer cells on a protected sheet
<i>Int_CreateError</i>	Error setting integer cells

**Remarks:** The use of integer variables can dramatically increase total solution time.

### Example:

To constrain cell F6 to be a general integer using the range name *staff*, enter:

```
WBINT "staff", "F6"
```

### To Remove:

If you wish to delete a *WBINT* range name using VBA instead of the *Delete* button on the *Integer-Binary* dialog box, you can use:

```
ActiveWorkbook.Names("WBINTstaff").Delete.
```

This statement removes the *WBINT* range name, thereby returning the adjustable cells contained in the former range to normal status.

## **wbInteger**

For additional discussion of the functionality provided, see the section entitled *Integer*, which refers to the *Integer* dialog box that calls this procedure.

This routine is used to build the integer ranges *WBBIN* and *WBINT*. Adjustable cells contained in these ranges will be restricted to integral values by the *What'sBest!* solver. If you wish to delete an integer range name using VBA instead of the *Delete* button on the *Integer* dialog box, you can use:

*ActiveWorkbook.Names("WBBINmyRange").Delete*. This statement removes the integer range name, thereby returning the adjustable cells contained in the former range to normal status.

**Syntax:** `wbInteger([IntName], [Refers_to], [IntChoice])`

<b>Argument</b>	<b>Required</b>	<b>Description</b>
<i>IntName</i>	No	<i>IntName</i> is a string that refers to the range being made integer.
<i>Refers_to</i>	No	<i>Refers_to</i> is the range or address of the cell(s) to be specified as integer. If omitted, the default value is the current selection.
<i>IntChoice</i>	No	<i>IntChoice</i> is a string to indicate if the cells should be binary or general integer. <i>IntChoice</i> accepts <i>BIN</i> or <i>BINARY</i> for binary (0/1) and <i>INT</i> or <i>GENERAL</i> for general integer. If omitted, the default is binary. For backwards compatibility with earlier versions of <i>What'sBest!</i> , <i>IntChoice</i> also accepts the numbers 1 for binary and 2 for general.

<b>Error Codes</b>	<b>Description</b>
<i>Int_BadIntNameArg</i>	Bad <i>IntName</i> argument
<i>Int_BadRefers_toArg</i>	Bad <i>Refers_to</i> argument
<i>Int_BadIntChoiceArg</i>	Bad <i>IntChoice</i> argument
<i>Int_ProtectedSheetError</i>	Unable to set integer cells on a protected sheet
<i>Int_CreateError</i>	Error setting integer cells

**Remarks:** Integer variables can dramatically increase the solution time.

**Example:** To constrain cell F6 to be a general integer using the range name *staff*, enter:

```
wbInteger "staff", "F6", "General"
```

To constrain cell F7 to be a binary integer using the range name *OnOff*, enter:

```
wbInteger "OnOff", "F7", "Binary"
```

**Note:** The second of these two examples could be done without the *IntChoice* argument of "Binary", which is the default.

## ***wbIntegerCard***

For additional discussion of the functionality provided, see the section entitled *Integer...|Special Ordered Set*, which refers to the Special Ordered Set - Cardinality dialog box that calls this procedure.

This routine is used to build the Cardinality ranges WBCARD. Adjustable cells contained in these ranges will be restricted to integral values by the What'sBest! solver. If you wish to delete a CARD function using VBA instead of deleting it on the spreadsheet, you can use: *Selection.Clear*. This statement clears the selected cell from any of its content.

**Syntax:** `wbIntegerCard(CardNumber, ArgList, Refers_to, [NoErrDialog])`

<b><i>Argument</i></b>	<b><i>Required</i></b>	<b><i>Description</i></b>
<i>CardNumber</i>	Yes	CardNumber is an integer meaning that, at most, N of the variables in the set will be allowed to be nonzero.
<i>ArgList</i>	Yes	ArgList is a string list of range or cells reference separated by a comma.
<i>Refers_to</i>	Yes	Refers_to is the range or address of the cell(s) to be specified as SOS.
<i>NoErrDialog</i>	No	Any argument passed here causes all What'sBest! error dialog boxes from the wbIntegerCard routine to be suppressed. Instead, the error number is delivered in this return argument. Pass an integer to use any possible returned What'sBest! error number. Useful in an embedded application of What'sBest!.

<b><i>Error Codes</i></b>	<b><i>Description</i></b>
<i>IntCard_BadCardNumberArg</i>	Bad CardNumber argument
<i>IntSos_BadArgListArg</i>	Bad ArgList argument
<i>IntSos_BadRefersToArg</i>	Bad Refers_to argument
<i>IntSos_ProtectedSheetError</i>	Unable to set integer cells on a protected sheet

Remarks:

Integer variables can dramatically increase the solution time.

Example:

To constrain cell F6 to be a general integer using the range name staff, enter:

```
wbIntegerCard 3, "Sheet1!$B$1,Sheet1!$C$1:$C$3", "Sheet1!$A$1"
```

The cell A1 then contains the function:

```
=WBCARD(3,Sheet1!$B$1,Sheet1!$C$1:$C$3)
```

***wbIntegerSemic***

For additional discussion of the functionality provided, see the section entitled *Integer...|Semi-continuous*, which refers to the Semi-continuous dialog box that calls this procedure.

This routine is used to build the Semi-continuous ranges WBSEMIC. Adjustable cells contained in these ranges will be restricted to integral values by the What'sBest! solver. If you wish to delete a SEMIC function using VBA instead of deleting it on the spreadsheet, you can use: *Selection.Clear*. This statement clears the selected cell from any of its content.

Syntax: wbIntegerSemic(LowerBound, UpperBound, ArgList, Refers\_to, [NoErrDialog])

<b><i>Argument</i></b>	<b><i>Required</i></b>	<b><i>Description</i></b>
<i>LowerBound</i>	Yes	LowerBound is a number indicating the lower bound in the range.
<i>UppererBound</i>	Yes	UpperBound is a number indicating the upper bound in the range.
<i>ArgList</i>	Yes	ArgList is a string list of range or cells reference separated by a comma.
<i>Refers_to</i>	Yes	Refers_to is the range or address of the cell(s) to be specified as SEMIC.
<i>NoErrDialog</i>	No	Any argument passed here causes all What'sBest! error dialog boxes from the wbIntegerSemic routine to be suppressed. Instead, the error number is delivered in this return argument. Pass an integer to use any possible returned What'sBest! error number. Useful in an embedded application of What'sBest!.

<b><i>Error Codes</i></b>	<b><i>Description</i></b>
<i>IntSemic_BadLowerBoundArg</i>	Bad LowerBound argument

<i>IntSemic_BadUpperBoundArg</i>	Bad UpperBound argument
<i>IntSemic_BadArgListArg</i>	Bad ArgList argument
<i>IntSemic_BadRefersToArg</i>	Bad Refers_to argument
<i>IntSemic_ProtectedSheetError</i>	Unable to set integer cells on a protected sheet

Remarks:

Integer variables can dramatically increase the solution time.

Example:

To constrain cell F6 to be a general integer using the range name staff, enter:

```
wbIntegerSemic 10, 20, "Sheet1!$B$1,Sheet1!$C$1:$C$3", "Sheet1!$A$1"
```

The cell A1 then contains the function:

```
=WBCARD(10,20,Sheet1!$B$1,Sheet1!$C$1:$C$3)
```

### **wbIntegerSos**

For additional discussion of the functionality provided, see the section entitled *Integer...|Special Ordered Set*, which refers to the *Special Ordered Set - Cardinality* dialog box that calls this procedure.

This routine is used to build the SOS ranges *WBSOSx*. Adjustable cells contained in these ranges will be restricted to integral values by the *What'sBest!* solver. If you wish to delete a SOS function using VBA instead of deleting it on the spreadsheet, you can use: *Selection.Clear*. This statement clears the selected cell from any of its content.

Syntax: `wbIntegerSos(TypeSos, ArgList, Refers_to, [NoErrDialog])`

<b>Argument</b>	<b>Required</b>	<b>Description</b>
TypeSos	Yes	TypeSos is an integer that refers to the type of the SOS: - "1" for type 1, - "2" for type 2, - "3" for type 3.
ArgList	Yes	ArgList is a string list of range or cells reference separated by a comma.
Refers_to	Yes	Refers_to is the range or address of the cell(s) to be specified as SOS.
NoErrDialog	No	Any argument passed here causes all <i>What'sBest!</i> error dialog boxes from the <code>wbIntegerSos</code> routine to be suppressed. Instead, the error number is delivered in this return argument. Pass an integer to use any possible returned <i>What'sBest!</i> error number. Useful in an embedded application of <i>What'sBest!</i> .

<b>Error Codes</b>	<b>Description</b>
IntSos_BadTypeSosArg	Bad TypeSos argument
IntSos_BadArgListArg	Bad ArgList argument
IntSos_BadRefersToArg	Bad Refers_to argument
IntSos_ProtectedSheetError	Unable to set integer cells on a protected sheet

Remarks:

Integer variables can dramatically increase the solution time.

Example:

To constrain cell F6 to be a general integer using the range name *staff*, enter:

```
wbIntegerSos 1, "Sheet1!$B$1,Sheet1!$C$1:$C$3", "Sheet1!$A$1"
```

The cell A1 then contains the function:

```
=WBSOS1(Sheet1!$B$1,Sheet1!$C$1:$C$3
```

---

### ***wbIntegerSolverKBestReport***

For additional discussion of the functionality provided, see the section entitled *Options...Integer Solver*, and *Usage Guidelines for K-Best Solutions*, which refers to the dialog box that calls this procedure.

This routine is used to build *WBIKB\_REP* function with ranges, which are areas of the worksheet that *What'sBest!* will see the trade-off cells while solving. This function will need to be used in conjunction with the option *KBest* defined via the *wbSetIntegerOptions*.

Syntax: `wbIntegerSolverKBestReport(ArgList, Refers_to, [NoErrDialog])`

<b>Argument</b>	<b>Required</b>	<b>Description</b>
<i>KBestName</i>	Yes	<i>ArgList</i> is the range or address of the cell(s) to be read.
<i>Refers_to</i>	Yes	<i>Refers_to</i> is a cell reference to specify in which to write the <i>WBIKB_REP</i> function.
<i>NoErrDialog</i>	No	Any argument passed here causes all <i>What'sBest!</i> error dialog boxes from the <i>wbIntegerSolverKBestReport</i> routine to be suppressed. Instead, the error number is delivered in this return argument. Pass an integer to use any possible returned <i>What'sBest!</i> error number. Useful in an embedded application of <i>What'sBest!</i> .

---



<b>Error Codes</b>	<b>Description</b>
<i>IKBest_BadArgListRepArg</i>	Bad <i>ArgList</i> argument
<i>IKBest_BadRefersToRepArg</i>	Bad <i>Refers_to</i> argument
<i>IKBest_ProtectedSheetRepError</i>	Unable to set KBest cells on a protected sheet

Example:

To define an KBest trade-off range F3:F10, and place the function WBIKB\_REP in H3, enter:

```
wbIntegerSolverKBestReport "F3:F10", "H3"
```

See sample *Knapsack\_KBest.xlsx*.

**WBOMIT**

For additional discussion of the functionality provided, see the section entitled *Advanced...|Omit*, which refers to the dialog box that calls this procedure.

This routine is used to build *WBOMIT* ranges, which are areas of the worksheet that *What'sBest!* will ignore while solving. If you wish to delete a *WBOMIT* range name using VBA instead of the *Delete* button on the *Omit* dialog box, you can use:

*ActiveWorkbook.Names("WBOMITmyRangeName").Delete*. This statement removes the *WBOMIT* range name.

Syntax: WBOMIT(OmitName, [Refers\_to])

<b>Argument</b>	<b>Required</b>	<b>Description</b>
<i>OmitName</i>	Yes	<i>OmitName</i> is a string that refers to the range that is to be ignored.
<i>Refers_to</i>	No	<i>Refers_to</i> is the range or address of the cell(s) to be ignored. If omitted, the default is the current selection.

<b>Error Codes</b>	<b>Description</b>
<i>Omit_BadOmitNameArg</i>	Bad <i>OmitName</i> argument
<i>Omit_BadRefers_toArg</i>	Bad <i>Refers_to</i> argument
<i>Omit_ProtectedSheetError</i>	Unable to set omit cells on a protected sheet
<i>Omit_CreateError</i>	Error setting omit cells

Remarks: Cells that are in an omit range can't be referenced by any cell outside of an omit range.

Example:

To define an omit range D10:H20 using the range name *Report*, enter:

```
WBOMIT "Report", "D10:H20"
```

To Remove:

If you wish to delete a *WBOMIT* range name using VBA instead of the *Delete* button on the *Omit* dialog box, you can use:

```
ActiveWorkbook.Names("WBOMITReport").Delete.
```

This statement removes the *WBOMIT* range name, thereby returning the adjustable cells contained in the former range to normal status.

### ***wbResetOptionsToDefault***

For further discussion of the functionality provided, see the section entitled *Options...|Reset To Default*.

This procedure has no arguments and resets all of the workbook options to their default values.

Syntax: `wbResetOptionsToDefault()`

<b>Error Code</b>	<b>Description</b>
<i>ResetOptionsToDefaultError</i>	Error in resetting options to default

### ***wbSetFunctionSupport***

This routine can be used to set the *What'sBest!* function support option seen in the *Function Support* dialog box. There is only one argument required. For additional discussion of the options available through this routine, see the section entitled *Advanced...|FunctionSupport*.

Syntax: `wbSetFunctionSupport(AdvFunctionSupport)`

<b>Argument</b>	<b>Required</b>	<b>Default</b>	<b>Description</b>
<i>AdvFunctionSupport</i>	Yes	0 (False)	<i>AdvFunctionSupport</i> is a True/False flag indicating whether or not to use this support.

<b>Error Codes</b>	<b>Description</b>
<i>AdvFunc_BadAdvFunctionSupportArg</i>	Bad <i>AdvFunctionSupport</i> argument

Example:

If one wished to set all the function support options, the simplest syntax would be:

```
wbSetFunctionSupport True
```

or by the named argument:

```
wbSetFunctionSupport AdvFunctionSupport:=True
```

**Note:** The *AdvFunctionSupport* argument should be set to TRUE in order to use the other arguments.

***wbSetGeneralOptions***

This routine is used to set the What's*Best!* general options. These options constitute the majority of the options seen in the General Options dialog box. All arguments are optional. For additional discussion of the options available through this routine, see the section entitled *Options... |General*.

Syntax: `wbSetGeneralOptions([goFeasTol], [goIterLimit], [goRuntimeLimit], [goNumberThreadsLimit], [goThreadChoice], [goIndSlack], [goAutoSelectFreeIntOmit], [goMinimizeExcel], [goHideStatusWindow], [goLinearizationDegree], [goLinearizationDelta], [goLinearizationBigM], [goStatusReport], [goStatusReportBegEnd], [goSolutionReport], [goWrnNonlinear], [goWrnBest], [goWrnBlank], [goWrnFunction], [goWrnStringArg], [goWrnIrreConst], [goWrnInfeasConst], [goWrnUnboundVar], [goWrnSupLookupFct])`

<b>Argument</b>	<b>Required</b>	<b>Default</b>	<b>Description</b>
<i>goFeasTol</i>	No	0.0000001	<i>goFeasibilityTol</i> is a positive number indicating the amount of violation tolerated in constraints.
<i>goIterLimit</i>	No	None	<i>goIterLimit</i> is an integer indicating how many tries to allow in solving the model.
<i>goRuntimeLimit</i>	No	None	<i>goRuntimeLimit</i> is an integer indicating the maximum number of seconds to be used in solving the model.
<i>goNumberThreadsLimit</i>	No	1	<i>goNumberThreadsLimit</i> is an integer specifying the number of threads, between 1 and 32.
<i>goThreadChoice</i>	No	0	<i>goThreadChoice</i> is an integer specifying the choice for the threads: 0: Solver Decides, 1: Parallel Preferred,

			2: Parallel Only, 3: Concurrent Preferred, 4: Concurrent Only.
<i>goIndSlack</i>	No	1 (Indicator)	<i>goIndSlack</i> is an integer indicating what form to display constraints in (1-Indicator, 2 – Slack).
<i>goAutoSelectFreeIntOmit</i>	No	1 (True)	<i>goAutoSelectFreeInt</i> is a True/False flag indicating whether to automatically select Free, Integer or Omit range names.
<i>goMinimizeExcel</i>	No	0 (False)	<i>goMinimizeExcel</i> is a True/False flag indicating whether to minimize Excel® during the solution process.
<i>goHideStatusWindow</i>	No	0 (False)	<i>goHideStatusWindow</i> is a True/False flag indicating whether to minimize the status window during the solution process.
<i>goLinearizationDegree</i>	No	0 (Solver Decides)	<i>goLinearizationDegree</i> is an integer indicating the degree of linearization to use: 0: Solver Decides, 1: None, 2: Mathematical, 3: Mathematical, Logical.
<i>goLinearizationDelta</i>	No	0.000001	<i>goLinearizationDelta</i> is a number indicating the Delta coefficient.
<i>goLinearizationBigM</i>	No	100000	<i>goLinearizationBigM Coefficient</i> is a number indicating the Big M coefficient.
<i>goStatusReport</i>	No	0 (Always Created)	<i>goStatusReport</i> is an integer indicating when to show the status report: 0: Always Created, 1: Never Created, 2: Only on Error/Warning.
<i>goStatusReportBegEnd</i>	No	0 (Beginning)	<i>goStatusReportBegEnd</i> is a flag indicating the location of the reports in the workbook: 0: Beginning, 1: End.
<i>goSolutionReport</i>	No	2 (Never Created)	<i>goSolutionReport</i> is an integer indicating whether to show the solution report: 0: Always Created, 1: Always Created with Details, 2: Never Created.
<i>goWrnNonlinear</i>	No	1 (True)	<i>Nonlinearity</i> is a True/False flag

			indicating whether to provide warning of nonlinear formulas or not.
<i>goWrnBest</i>	No	1 (True)	<i>goWrnBest</i> is a True/False flag indicating whether to provide warning on presence of Best cell.
<i>goWrnBlank</i>	No	0 (False)	<i>goWrnBlank</i> is a True/False flag indicating whether to provide warning of blank cells referenced in formulas or not.
<i>goWrnFunction</i>	No	1 (True)	<i>goWrnFunction</i> is a True/False flag indicating whether to provide warning of unsupported functions or not.
<i>goWrnStringArg</i>	No	1 (True)	<i>goWrnStringArg</i> is a True/False flag indicating whether to provide warning of string, text argument in formulas.
<i>goWrnIrreConst</i>	No	1 (True)	<i>goWrnIrreConst</i> is a True/False flag indicating whether to provide warning of irreconcilable constraints or not.
<i>goWrnInfeasConst</i>	No	0 (False)	<i>goWrnInfeasConst</i> is a True/False flag indicating whether to provide warning of infeasible constraints or not.
<i>goWrnUnboundVar</i>	No	0 (False)	<i>goWrnUnboundVar</i> is a True/False flag indicating whether to provide warning of unbounded variables or not.
<i>goWrnSupLookupFct</i>	No	1 (True)	<i>goWrnSupLookupFct</i> is a True/False flag indicating whether to provide warning of supported lookup functions or not.

<b>Error Codes</b>	<b>Description</b>
<i>Opt_BadFeasibilityToleranceArg</i>	Bad Feasibility Tolerance argument
<i>Opt_BadIterLimitArg</i>	Bad Iteration Limit argument
<i>Opt_BadRuntimeLimitArg</i>	Bad Runtime Limit argument
<i>Opt_BadSelectRefersToArg</i>	Bad Select Refers To argument
<i>Opt_BadNumberThreadsLimitArg</i>	Bad Number Threads Limit To argument
<i>Opt_BadThreadChoiceArg</i>	Bad Thread Choice argument
<i>Opt_BadMinimizeExcelArg</i>	Bad Minimize Excel® argument
<i>Opt_BadHideStatusArg</i>	Bad Hide Status argument

<i>Opt_BadConstraintIndSlackArg</i>	Bad Constraint Indicator argument
<i>Opt_BadLinearizationDegArg</i>	Bad Linearization Degree argument
<i>Opt_BadDeltaCoeffArg</i>	Bad Delta coefficient argument
<i>Opt_BadBigMCoeffArg</i>	Bad Big M coefficient argument
<i>Opt_BadStatusReportArg</i>	Bad Status Report argument
<i>Opt_BadReportsLocationArg</i>	Bad Reports Location argument
<i>Opt_BadSolutionReportArg</i>	Bad Solution Report argument
<i>Opt_BadNonlinearityArg</i>	Bad Nonlinearity argument
<i>Opt_BadNoObjectiveArg</i>	Bad No Objective argument
<i>Opt_BadBlankCellsArg</i>	Bad Blank Cells argument
<i>Opt_BadUnsupportedFunctionArg</i>	Bad Unsupported Function argument
<i>Opt_BadStringArgumentArg</i>	Bad String Argument argument
<i>Opt_BadIrreConstraintArg</i>	Bad Irreconcilable Constraint argument
<i>Opt_BadInfeasConstraintArg</i>	Bad Infeasible Constraint argument
<i>Opt_BadUnboundVarArg</i>	Bad Unbounded Variable argument
<i>Opt_BadSupLookupFctArg</i>	Bad Support Lookup Functions argument

---

Example:

Arguments should be provided as follows:

If one wished to set all the options, the simplest syntax would be:

```
wbSetGeneralOptions 0.0000002, 77, 88, 1, 0, 2, True, False, False, _
1, 0.2, 222222, 1, 1, 1, False, True, False, False, _
False, True, False, False, True
```

To set one or more options, named arguments should be used:

```
wbSetGeneralOptions goSolutionReport:=1, goWrnBlank:=1
```

***wbSetGlobalOptions***

This routine is used to set the *What'sBest!* global solver options seen in the *Global Solver Options* dialog box. For additional discussion of the options available through this routine, see the section entitled *Options. . . |Global Solver*. All arguments are optional.

Syntax: `wbSetGlobalOptions( [GIStratGlobal], [GIMultistartAttempts], [GLOptimalityTolerance], [GIDeltaTolerance], [GIVariableBoundLimit], [GIUseBoundLimit], [GIBranchingDirection], [GIBoxSelection], [GIAlgebraicReformulation])`

<b>Argument</b>	<b>Required</b>	<b>Default</b>	<b>Description</b>
<i>GIStratGlobal</i>	No	0 (False)	<i>GIStratGlobal</i> is a True/False flag indicating whether or not to use this strategy.
<i>GIMultistartAttempts</i>	No	0 (Solver Decides)	<i>GIMultistartAttempts</i> is a positive number indicating the multistart attempts: 0: <i>Solver Decides</i> , 1: <i>Off</i> , 2 or more: number of attempts.
<i>GLOptimalityTolerance</i>	No	0.000001	<i>GLOptimalityTolerance</i> is a number between 0 and 1 indicating the optimality tolerance.
<i>GIDeltaTolerance</i>	No	0.0000001	<i>GIDeltaTolerance</i> is a number between 0 and 1 indicating the delta tolerance.
<i>GIVariableBoundLimit</i>	No	1000000000	<i>GIVariableBoundLimit</i> is a positive integer indicating the variable bound limit.
<i>GIUseBoundLimit</i>	No	0 (Solver Decides)	<i>GIUseBoundLimit</i> indicates the use of bound limit:

			0: <i>Solver Decides</i> , 1: <i>None</i> , 2: <i>All Variables</i> , 3: <i>Selected Variables</i> .
<i>GlBranchingDirection</i>	No	0 (Solver Decides)	<i>GlBranchingDirection</i> indicates the branching direction: 0: <i>Solver Decides</i> , 1: <i>Absolute Width</i> , 2: <i>Local Width</i> , 3: <i>Global Width</i> , 4: <i>Global Distance</i> , 5: <i>Absolute Violation</i> , 6: <i>Relative Violation</i> .
<i>GlBoxSelection</i>	No	0 (Solver Decides)	<i>GlBoxSelection</i> indicates the box selection: 0: <i>Solver Decides</i> , 1: <i>Depth First</i> , 2: <i>Worst Bound</i> , 3: <i>Best Bound</i> .
<i>GlAlgebraicReformulation</i>	No	0 (Solver Decides)	<i>GlAlgebraicReformulation</i> indicates the algebraic reformulation: 0: <i>Solver Decides</i> , 1: <i>None</i> , 2: <i>Minimum</i> , 3: <i>Medium</i> , 4: <i>Maximum</i> .

<b>Error Codes</b>	<b>Description</b>
<i>GlobalOpt_BadGlStratGlobalArg</i>	Bad <i>Global Solver</i> argument.
<i>GlobalOpt_BadGlMultistartAttemptsArg</i>	Bad <i>Multistart Attempts</i> argument.
<i>GlobalOpt_BadGlOptimalityToleranceArg</i>	Bad <i>Optimality Tolerance</i> argument.
<i>GlobalOpt_BadGlDeltaToleranceArg</i>	Bad <i>Delta Tolerance</i> argument.
<i>GlobalOpt_BadGlVariableBoundLimitArg</i>	Bad <i>Variable Bound Limit</i> argument.
<i>GlobalOpt_BadGlUseBoundLimitArg</i>	Bad <i>Use of Bound Limit</i> argument.
<i>GlobalOpt_BadGlBranchingDirectionArg</i>	Bad <i>Branching Direction</i> argument.
<i>GlobalOpt_BadGlBoxSelectionArg</i>	Bad <i>Box Selection</i> argument.
<i>GlobalOpt_BadGlAlgebraicReformulationArg</i>	Bad <i>Algebraic Reformulation</i> argument.



**Example:** If one wished to set all the options, the following would work:

```
wbSetGlobalOptions True, 4, 0.0001, 0.000001, 100000000, _
1, 2, 1, 2
```

To set individual options (here setting *Multistart Attempts* to 4), named arguments should be used:

```
wbSetGlobalOptions G1MultistartAttempts:=4
```

**Note:** The global solver needs the nonlinear option and the mixed integer option to operate.

### ***wbSetIntegerOptions***

This routine is used to set the *What'sBest!* integer options displayed in the *Integer Solver Options* dialog box. All arguments are optional. For additional discussion of the options available through this routine, see the section entitled *Options... |Integer Solver*.

**Syntax:** `wbSetIntegerOptions([BranchingDirection], [AbsoluteIntegrity], [RelativeIntegrity], [WarmStartLP], [ColdStartLP], [AbsoluteOptimality], [RelativeOptimality], [TimeToRelativeOptimality], [HurdleTolerance], [NodeSelectionTolerance], [StrongBranchTolerance], [, [KBest], [KBestReport], [BNPBlocks], [BNPHeuristic])`

<b>Argument</b>	<b>Required</b>	<b>Default</b>	<b>Description</b>
<i>BranchingDirection</i>	No	0 (Both)	<i>BranchingDirection</i> is an integer indicating the preferred direction of branching: 0: <i>Both</i> , 1: <i>Up</i> , 2: <i>Down</i> .
<i>AbsoluteIntegrity</i>	No	0.000001	<i>AbsoluteIntegrity</i> is a fractional value indicating the absolute amount of violation from integrity that is acceptable for the integer variables.
<i>RelativeIntegrity</i>	No	0.000008	<i>RelativeIntegrity</i> is a fractional value indicating the relative amount of violation from integrity that is acceptable for the integer variables.
<i>WarmStartLP</i>	No	0 (Solver Decides)	<i>WarmStartLP</i> is an integer value indicating the linear solver to use during branch-and-bound when a starting basis is present: 0: <i>Solver Decides</i> , 1: <i>Barrier</i> , 2: <i>Primal</i> , 3: <i>Dual</i> .
<i>ColdStartLP</i>	No	0 (Solver	<i>ColdStartLP</i> is an integer value

		Decides)	indicating the linear solver to use during branch-and-bound when a starting basis is <i>not</i> present: 0: <i>Solver Decides</i> , 1: <i>Barrier</i> , 2: <i>Primal</i> , 3: <i>Dual</i> .
<i>AbsoluteOptimality</i>	No	0	<i>AbsoluteOptimality</i> is a positive value $r$ , indicating to the branch-and-bound solver that it should only search for integer solutions with objective values at least $r$ units better than the best integer solution found so far.
<i>RelativeOptimality</i>	No	0.00001	<i>RelativeOptimality</i> is a value $r$ , ranging from 0 to 1, indicating to the branch-and-bound solver that it should only search for integer solutions with objective values at least $100*r\%$ better than the best integer solution found so far.
<i>TimeToRelativeOptimality</i>	No	100	<i>TimeToRelativeOptimality</i> is the number of seconds before the branch-and-bound solver resorts to using the <i>RelativeOptimality</i> tolerance.
<i>HurdleTolerance</i>	No	None	<i>HurdleTolerance</i> is a value of a known integer solution. What'sBest! will only search for any feasible integer solution if it is at least as good as the bound specified in <i>HurdleTolerance</i> (0: None).
<i>NodeSelectionTolerance</i>	No	0 (Solver Decides)	<i>NodeSelectionTolerance</i> controls the order in which the branch-and-bound solver selects branch nodes in the tree: 0: <i>Solver Decides</i> , 1: <i>Depth First</i> , 2: <i>Worst Bound</i> , 3: <i>Best Bound</i> .
<i>StrongBranchTolerance</i>	No	10	The <i>StrongBranchTolerance</i> option uses a more intensive branching strategy during the first $n$ levels of the branch-and-bound tree, where $n$ is the option's setting. During these initial levels, the solver picks a subset of the fractional variables as branching candidates, performs a tentative branch on each of

			the variables in the subset, and selects as the final candidate the variable that offers the greatest improvement in the bound on the objective.
<i>KBest</i>	No	1	<i>KBest</i> is an integer indicating the number of solutions desired as part of the K-Best solutions feature. The WBKBEST function is used to specify the trade-off cells.
<i>KBestReport</i>	No	False (Off)	<i>KBestReport</i> is a boolean indicating the generation of the K-Best report. The reporting cells may be defined with the function <i>wbIntegerSolverKBestReport</i> .
<i>BNPBlocks</i>	No	0 or 1 (Off)	<i>BNPBlocks</i> is an integer indicating the number of blocks defined with the Branch-and-Price solver, and should be greater or equal than 2.
<i>BNPHeuristic</i>	No	1 (GP1)	<i>BNPHeuristic</i> is an integer indicating the type of heuristic to use as part of the Branch-and-Price solver, where 1 is GP1, and 2 for GP2.

<b>Error Codes</b>	<b>Description</b>
<i>IntOpt_BadBranchingDirectionArg</i>	Bad <i>BranchingDirection</i> argument.
<i>IntOpt_BadAbsoluteIntegralityArg</i>	Bad <i>AbsoluteIntegrality</i> argument.
<i>IntOpt_BadRelativeIntegralityArg</i>	Bad <i>RelativeIntegrality</i> argument.
<i>IntOpt_BadWarmStartArg</i>	Bad <i>WarmStart</i> argument.
<i>IntOpt_BadColdStartArg</i>	Bad <i>ColdStart</i> argument.
<i>IntOpt_BadAbsoluteOptimalityArg</i>	Bad <i>AbsoluteOptimality</i> argument.
<i>IntOpt_BadRelativeOptimalityArg</i>	Bad <i>RelativeOptimality</i> argument.
<i>IntOpt_BadTimeToRelative</i>	Bad <i>TimeToRelative</i> argument.
<i>IntOpt_BadHurdleArg</i>	Bad <i>Hurdle</i> argument.
<i>IntOpt_BadNodeSelectionArg</i>	Bad <i>NodeSelection</i> argument.
<i>IntOpt_BadStrongBranchArg</i>	Bad <i>StrongBranch</i> argument.

<i>IntOpt_BadKBestArg</i>	Bad <i>IntOpt_BadKBestArg</i> argument.
<i>IntOpt_BadKBestReportArg</i>	Bad <i>IntOpt_BadKBestReportArg</i> argument.
<i>IntOpt_BadBNPBlocksArg</i>	Bad <i>IntOpt_BadBNPBlocksArg</i> argument.
<i>IntOpt_BadBNPHeuristicArg</i>	Bad <i>IntOpt_BadBNPHeuristicArg</i> argument.

**Example:** If one wished to set all the options, the following would work:

```
wbSetIntegerOptions 1, .000001, .00001, 3, 1, .00008, _
.01, 120, 0, 1, 20, 1, False, 0, 1
```

To set individual options (here setting the *RelativeOptimality* tolerance to 10%), named arguments should be used:

```
wbSetIntegerOptions RelativeOptimality=.1
```

---

### ***wbSetIntegerPreSolverOptions***

This routine is used to set the *What'sBest!* integer pre-solver options seen in the *Integer Pre-Solver Options* dialog box. For additional discussion of the options available through this routine, see the section entitled *Options... |Integer Pre-Solver*. All arguments are optional.

**Syntax:** `wbSetIntegerPreSolverOptions( [HeuristicLevel], [ProbingLevel], [MaxCutsPasses], [RelativeCutsLimit], [CoefficientReduction], [Disaggregation], [FlowCover], [GCD], [Gomory], [GUB], [KnapsackCover], [Lattice], [Lifting], [PlantLocation], [ObjIntegrality], [Basic], [Cardinality], [Disjunctive])`

<b>Argument</b>	<b>Required</b>	<b>Default</b>	<b>Description</b>
<i>HeuristicLevel</i>	No	3 (High)	<i>HeuristicLevel</i> controls the level of integer programming heuristics used by the integer solver. These heuristics use the continuous solution at each node in the branch-and-bound tree to attempt to quickly find a good integer solution: 0: <i>None</i> , 1: <i>Low</i> , 2: <i>Medium</i> , 3: <i>High</i> .
<i>Cutoff Criterion</i>	No	0 (Solver Decides)	The <i>Cutoff Criterion</i> is used to control the criterion for terminating heuristics: 0: <i>Solver Decides</i> , 1: <i>Time</i> , 2: <i>Iterations</i> .
<i>ProbingLevel</i>	No	0 (Solver Decides)	<i>ProbingLevel</i> controls the amount of probing that occurs in integer models. Probing involves taking a close look at the integer variables in a model and deducing tighter

---

			variable bounds and right-hand side values. In many cases, probing can tighten an integer model sufficiently to speed overall solution times: 0: <i>Solver Decides</i> , 1: <i>None</i> , 2-10: increasing <i>levels</i> of probing.
<i>MaxCutsPasses</i>	No	200	<i>MaxCutsPasses</i> sets the maximum number of iterative passes through a model determining appropriate constraint cuts to append to the formulation.
<i>RelativeCutsLimit</i>	No	0.5	<i>RelativeCutsLimit</i> is a fractional value imposing a relative limit on the number of constraint cuts that are generated. The default limit is set to 0.5 times the number of true constraints in the original formulation.
<i>CoefficientReduction</i>	No	1 (True)	<i>CoefficientReduction</i> is used to enable or disable coefficient reduction cuts (False: <i>Disable</i> , True: <i>Enable</i> ).
<i>Disaggregation</i>	No	1 (True)	<i>Disaggregation</i> used to enable or disable disaggregation cuts (False: <i>Disable</i> , True: <i>Enable</i> ).
<i>FlowCover</i>	No	1 (True)	<i>FlowCover</i> is used to enable or disable flow cover cuts (0: <i>Disable</i> , 1: <i>Enable</i> ).
<i>GCD</i>	No	1 (True)	<i>GCD</i> is used to enable or disable greatest common denominator cuts (0: <i>Disable</i> , 1: <i>Enable</i> ).
<i>Gomory</i>	No	1 (True)	<i>Gomory</i> is used to enable or disable Gomory cuts (0: <i>Disable</i> , 1: <i>Enable</i> ).
<i>GUB</i>	No	1 (True)	<i>GUB</i> is used to enable or disable generalized upper bound cuts (0: <i>Disable</i> , 1: <i>Enable</i> ).
<i>KnapsackCover</i>	No	1 (True)	<i>KnapsackCover</i> is used to enable or disable knapsack cover cuts (0: <i>Disable</i> , 1: <i>Enable</i> ).
<i>Lattice</i>	No	1 (True)	<i>Lattice</i> is used to enable or disable lattice cuts (0: <i>Disable</i> , 1: <i>Enable</i> ).
<i>Lifting</i>	No	1 (True)	<i>Lifting</i> is used to enable or disable lifting cuts (0: <i>Disable</i> , 1: <i>Enable</i> ).
<i>PlantLocation</i>	No	1 (True)	<i>PlantLocation</i> is used to enable or disable plant location cuts (0: <i>Disable</i> , 1: <i>Enable</i> ).
<i>ObjIntegrity</i>	No	0 (False)	<i>ObjIntegrity</i> is used to enable or disable the

			objective integrality cuts (0: <i>Disable</i> , 1: <i>Enable</i> )
<i>Basic</i>	No	1 (True)	<i>Basic</i> is used to enable or disable the basic cuts (0: <i>Disable</i> , 1: <i>Enable</i> )
<i>Cardinality</i>	No	0 (False)	<i>Cardinality</i> is used to enable or disable the objective cardinality cuts (0: <i>Disable</i> , 1: <i>Enable</i> )
<i>Disjunctive</i>	No	1 (True)	<i>Disjunctive</i> is used to enable or disable the objective disjunctive cuts (0: <i>Disable</i> , 1: <i>Enable</i> ).

<b>Error Codes</b>	<b>Description</b>
<i>IntPreSolvOpt_BadHeuristicLevelArg</i>	Bad <i>Heuristic Level</i> argument.
<i>IntPreSolvOpt_BadCutoffCriterionArg</i>	Bad <i>Cutoff Criterion</i> argument.
<i>IntPreSolvOpt_BadProbingLevelArg</i>	Bad <i>Probing Level</i> argument.
<i>IntPreSolvOpt_BadMaxCutsPassesArg</i>	Bad <i>Max Cuts Passes</i> argument.
<i>IntPreSolvOpt_BadRelativeCutsLimitArg</i>	Bad <i>Relative Cuts Limit</i> argument.
<i>IntPreSolvOpt_BadCoefficientReductionCutsArg</i>	Bad <i>Coefficient Reduction Cuts</i> argument.
<i>IntPreSolvOpt_BadDisaggregationCutsArg</i>	Bad <i>Disaggregation Cuts</i> argument.
<i>IntPreSolvOpt_BadFlowCoverCutsArg</i>	Bad <i>Flow Cover Cuts</i> argument.
<i>IntPreSolvOpt_BadGCDCutsArg</i>	Bad <i>GCD Cuts</i> argument.
<i>IntPreSolvOpt_BadGomoryCutsArg</i>	Bad <i>Gomory Cuts</i> argument.
<i>IntPreSolvOpt_BadGUBCutsArg</i>	Bad <i>GUB Cuts</i> argument.
<i>IntPreSolvOpt_BadKnapsackCoverCutsArg</i>	Bad <i>Knapsack Cover Cuts</i> argument.
<i>IntPreSolvOpt_BadLatticeCutsArg</i>	Bad <i>Lattice Cuts</i> argument.
<i>IntPreSolvOpt_BadLiftingCutsArg</i>	Bad <i>Lifting Cuts</i> argument.
<i>IntPreSolvOpt_BadPlantLocationCutsArg</i>	Bad <i>Plant Location Cuts</i> argument.
<i>IntPreSolvOpt_BadObjIntegralityCutsArg</i>	Bad <i>Objective Integrality Cuts</i> argument.
<i>IntPreSolvOpt_BadBasicCutsArg</i>	Bad <i>Basic Cuts</i> argument.
<i>IntPreSolvOpt_BadCardinalityCutsArg</i>	Bad <i>Cardinality Cuts</i> argument.
<i>IntPreSolvOpt_BadDisjunctiveCutsArg</i>	Bad <i>Disjunctive Cuts</i> argument.

Example: If one wished to set all the options, the following would work:

```
wbSetIntegerPreSolverOptions 2, 1, 6, 20, .3, _
False, False, True, True, False, True, True, _
False, False, True, True, False, True, True
```

To set individual options (here setting the *ProbingLevel* to 4), named arguments should be used:

```
wbSetIntegerPreSolverOptions ProbingLevel:=4
```

### **wbSetLinearOptions**

This routine is used to set the *What'sBest!* linear solver options, which can be seen in the *Linear Solver Options* dialog box. All arguments are optional. For additional discussion of the options available through this routine, see the section entitled *Options...|Linear Solver*.

Syntax: `wbSetLinearOptions([LinearSolverMethod], [ScaleModel], [Reduction], [PrimalPricing], [DualPricing])`

<b>Argument</b>	<b>Required</b>	<b>Default</b>	<b>Description</b>
<i>LinearSolverMethod</i>	No	0 (Solver Decides)	<i>LinearSolverMethod</i> is an integer indicating the linear solver method to employ: 0: <i>Solver Decides</i> , 1: <i>Primal Simplex</i> ; 2: <i>Dual Simplex</i> .
<i>ScaleModel</i>	No	1 (True)	<i>ScaleModel</i> is a True/False flag indicating whether to scale model.
<i>Reduction</i>	No	1 (True)	<i>Reduction</i> is a True/False flag indicating whether to use model reduction.
<i>PrimalPricing</i>	No	0 (Solver Decides)	<i>PrimalPricing</i> is an integer indicating what primal pricing method to use: 0: <i>Solver Decides</i> , 1: <i>Devex</i> ; 2: <i>Partial</i> .
<i>DualPricing</i>	No	0 (Solver Decides)	<i>DualPricing</i> is an integer indicating what dual pricing method to use: 0: <i>Solver Decides</i> , 1: <i>Partial</i> , 2: <i>Steepest Edge</i> .

<b>Error Codes</b>	<b>Description</b>
--------------------	--------------------

<i>LinOpt_BadScaleModelArg</i>	Bad ScaleModel argument
<i>LinOpt_BadReductionArg</i>	Bad Reduction argument
<i>LinOpt_BadLinearSolverMethodArg</i>	Bad LinearSolverMethod argument
<i>LinOpt_BadDualPricingArg</i>	Bad DualPricing argument
<i>LinOpt_BadPrimalPricingArg</i>	Bad PrimalPricing argument

**Example:** If one wished to set all the linear solver options, the simplest syntax would be:

```
wbSetLinearOptions 3, False, True, 2, 2
```

To set one or more options, named arguments should be used:

```
wbSetLinearOptions Reduction:=True
```

---

### ***wbSetNonlinearOptions***

This routine is used to set the What's*Best!* nonlinear solver options seen in the Nonlinear Solver Options dialog box. All arguments are optional. For additional discussion of the options available through this routine, see the section entitled Options...|Nonlinear Solver.

**Syntax:** *wbSetNonlinearOptions*([StratCrashInitial], [StratUseLINDOCrash], [StratSLPDirection], [StratSLPSolver], [StratQuadraticRecognition], [StratPresolve], [StratSelectiveConstraint], [StratSteepestEdge], [StartingPoint], [OptimalityTolerance], [IfLimitSlowProg], [Derivatives])

<b>Argument</b>	<b>Required</b>	<b>Default</b>	<b>Description</b>
<i>StratCrashInitial</i>	No	0 (False)	<i>StratCrashInitial</i> is a True/False flag indicating whether or not to use this strategy.
<i>StratUseLINDOCrash</i>	No	0 (False)	<i>StratUseLINDOCrash</i> is a True/False flag indicating whether or not to use this strategy.
<i>StratSLPDirection</i>	No	1(True)	<i>StratSLPDirection</i> is a True/False flag indicating whether or not to use this strategy.
<i>StratSLPSolver</i>	No	0 (False)	<i>StratSLPSolver</i> is a True/False flag indicating whether or not to use this strategy.
<i>StratQuadraticRecognition</i>	No	1(True)	<i>StratQuadraticRecognition</i> is a True/False flag indicating whether or not to use this strategy.
<i>StratPresolve</i>	No	1(True)	<i>StratPresolve</i> is a True/False flag indicating whether or not to use this strategy.
<i>StratSelectiveConstraint</i>	No	1(True)	<i>StratSelectiveConstraint</i> is a True/False flag indicating whether or not to use this strategy.

---



<i>StratSteepestEdge</i>	No	0 (False)	<i>StratSteepestEdge</i> is a True/False flag indicating whether or not to use this strategy.
<i>StartingPoint</i>	No	0 (False)	<i>StartingPoint</i> is a True/False flag indicating whether or not to use this feature.
<i>OptimalityTolerance</i>	No	0.0000001	<i>OptimalityTolerance</i> is a positive number indicating the optimality tolerance.
<i>ItLimitSlowProg</i>	No	100	<i>ItLimitSlowProg</i> is an integer greater than 2 indicating the iteration limit for slow progress.
<i>Derivatives</i>	No	0 (Solver Decides)	<i>Derivatives</i> can take 5 values: 0 for Solver Decides, 1 for Backward Analytical, 2 for Forward Analytical, 3 for Central Differences, 4 for Forward Differences.

<b>Error Codes</b>	<b>Description</b>
<i>NonlinOpt_BadStratCrashInitialArg</i>	Bad StratCrashInitial argument
<i>NonlinOpt_BadStratUseLINDOCrashArg</i>	Bad StratUseLINDOCrash argument
<i>NonlinOpt_BadStratSLPDirectionArg</i>	Bad StratSLPDirection argument
<i>NonlinOpt_BadStratSLPSolverArg</i>	Bad StratSLPSolver argument
<i>NonlinOpt_BadStratQuadraticRecognitionArg</i>	Bad StratQuadraticRecognition argument
<i>NonlinOpt_BadStratPresolveArg</i>	Bad StratPresolve argument
<i>NonlinOpt_BadStratSelectiveConstraintArg</i>	Bad StratSelectiveConstraint argument
<i>NonlinOpt_BadStratSteepestEdgeArg</i>	Bad StratSteepestEdge argument
<i>NonlinOpt_BadStartingPointArg</i>	Bad StartingPoint argument
<i>NonlinOpt_BadOptimalityToleranceArg</i>	Bad OptimalityTolerance argument
<i>NonlinOpt_BadItLimitSlowProgArg</i>	Bad ItLimitSlowProg argument
<i>NonlinOpt_BadDerivativesArg</i>	Bad Derivatives argument

Example:

If one wished to set all the nonlinear options, the simplest syntax would be:

```
wbSetNonlinearOptions True, True, True, True, True, True, False, True, False, 0.0001, 200, 1
```

To set one or more options, named arguments should be used:

```
wbSetNonlinearOptions OptimalityTolerance:=0.0001
```

---

## ***wbSetStochasticOptions***

This routine can be used to set the What's*Best!* stochastic solver options seen in the *Stochastic Solver* dialog box. All arguments are optional. For additional discussion of the options available through this routine, see the section entitled *Options...|Stochastic Solver*.

**Syntax:** `wbSetStochasticOptions([StochasticSolverMethod], [StochasticSeed], [StochasticSamplSize], [StochasticSamplCont], [StochasticEVWS], [StochasticEVEM], [StochasticEVPI], [StochasticEVMU], [StochasticRepScenHoriz])`

<b><i>Argument</i></b>	<b><i>Required</i></b>	<b><i>Default</i></b>	<b><i>Description</i></b>
<i>StochasticSolverMethod</i>	No	0 (Solver Decides)	StochasticSolverMethod is an integer indicating the stochastic solver method to employ: 0: Solver Decides, 1: Free, 2: Deterministic Equivalent, 3: Nested Benders Decomposition, 4: Augmented Lagrangian Decomposition, 5: Simple Benders Decomposition.
<i>StochasticSeed</i>	No	1031	StochasticSeed is a cell reference or an integer greater than 1 indicating the seed value for random generator.
<i>StochasticSamplSize</i>	No	2	StochasticSamplSize is an integer greater than 1 indicating the default number of scenarios per stage.
<i>StochasticSamplCont</i>	No	True	StochasticSamplCont is a True/False flag indicating whether or not to use this option.
<i>StochasticEVWS</i>	No	True	StochasticEVWS is a True/False flag indicating whether or not to use this option.
<i>StochasticEVEM</i>	No	True	StochasticEVEM is a True/False flag indicating whether or not to use this option.

<i>StochasticEVPI</i>	No	True	StochasticEVPI is a True/False flag indicating whether or not to use this option.
<i>StochasticEVMU</i>	No	False	StochasticEVMU is a True/False flag indicating whether or not to use this option.
<i>StochasticRepScenHoriz</i>	No	False	StochasticRepScenHoriz is a True/False flag indicating whether or not to use this option.

<b>Error Codes</b>	<b>Description</b>
<i>StoOpt_BadStochasticSolverMethodArg</i>	Bad StochasticSolverMethod argument
<i>StoOpt_BadStochasticSeedArg</i>	Bad StochasticSeed argument
<i>StoOpt_BadStochasticSamplContArg</i>	Bad StochasticSamplCont argument
<i>StoOpt_BadStochasticEVWSArg</i>	Bad StochasticEVWS argument
<i>StoOpt_BadStochasticEVEMArg</i>	Bad StochasticEVEM argument
<i>StoOpt_BadStochasticEVPIArg</i>	Bad StochasticEVPI argument
<i>StoOpt_BadStochasticEVMUArg</i>	Bad StochasticEVMU argument
<i>StoOpt_BadStochasticRepScenHorizArg</i>	Bad StochasticRepScenHoriz argument

Example:

If one wished to set all the stochastic support options, the simplest syntax would be:

```
wbSetStochasticOptions 2, 2027, False, False, False, False, True, False
```

To set one or more options, named arguments should be used:

```
wbSetStochasticOptions StochasticEVPI:=False
```

---

**Note:** The *AdvStochasticSupport* argument should be set to TRUE via the *wbSetStochasticSupport* function in order to use these options.

---

### ***wbSetStochasticSupport***

This routine can be used to set the *What'sBest!* stochastic support option seen in the Stochastic Support dialog box. There is only one argument. For additional discussion of the options available through this routine, see the section entitled *Options...|Stochastic Solver*.

**Syntax:** `wbSetStochasticSupport(AdvStochasticSupport)`

<b>Argument</b>	<b>Required</b>	<b>Description</b>
<code>AdvStochasticSupport</code>	Yes	<code>AdvStochasticSupport</code> is a True/False flag indicating whether or not to use this support. Default 0 (False).

<b>Error Codes</b>	<b>Description</b>
<code>Sto_BadAdvStochasticSupportArg</code>	Bad <code>AdvStochasticSupport</code> argument

**Example:**

If one wished to set all the function support options, the simplest syntax would be:

```
wbSetStochasticSupport True
```

or by the named argument:

```
wbSetStochasticSupport AdvStochasticSupport:=True
```

### ***wbSetStringSupport***

This routine can be used to set the *What'sBest!* string support option seen in the *String Support* dialog box. The first argument is required, the others are optional. For additional discussion of the options available through this routine, see the section entitled *Advanced...|String Support*.

**Syntax:** `wbSetStringSupport(AdvStringSupport, [AdvStringLength])`

<b>Argument</b>	<b>Required</b>	<b>Default</b>	<b>Description</b>
<code>AdvStringSupport</code>	Yes	0 (False)	<code>AdvStringSupport</code> is a True/False flag indicating whether or not to use this support.
<code>AdvStringLength</code>	No	20	<code>AdvStringLength</code> is an integer between 1 and 255 indicating the maximum string length.

<b>Error Codes</b>	<b>Description</b>
<i>AdvStr_BadAdvStringSupportArg</i>	Bad <i>AdvStringSupport</i> argument
<i>AdvStr_BadAdvStringLengthArg</i>	Bad <i>AdvStringLength</i> argument

**Examples:**

If one wished to set all the string support options, the simplest syntax would be:

```
wbSetStringSupport True, 10
```

To set one or more options, named arguments should be used:

```
wbSetStringSupport AdvStringSupport:=True
```

**Note:** The *AdvStringSupport* argument should be set to TRUE in order to use the *AdvStringLength* argument.

**wbSolve**

For additional discussion of the functionality provided by this routine, see *Solve*.

This routine is used to solve the active model.

**Syntax:** `wbSolve([SolutionStatus], [ExcelOpen], [NoErrDialog])`

<b>Argument</b>	<b>Required</b>	<b>Description</b>
<i>SolutionStatus</i>	No	<i>SolutionStatus</i> is a return integer on the condition of the solution: Globally Optimal (1), Globally Optimal (2), Infeasible (3), Unbounded (4), Feasible (5), Infeasible or Unbounded (6), Near Optimal (7), Locally Optimal (8), Locally Infeasible (9), Cutoff (10), Numerical Error (11), Unknown (12), Unloaded (13), Loaded (14), Unknown Error (other), where 1000 is an interruption from a calculation error, and 2000 is an interruption by the user.
<i>ExcelOpen</i>	No	<i>ExcelOpen</i> is a True/False flag to indicate whether Excel® should remain in the open state or be minimized (True to leave Excel® open, False to minimize Excel®). If this argument is omitted, it defaults to the value of the Minimize Excel® on Solve setting in the General Options dialog box.
<i>NoErrDialog</i>	No	Any argument (e.g., an integer) passed causes all What'sBest! error dialog boxes from the <i>wbSolve</i> routine to be suppressed. Instead, the error number is delivered in this return argument. Pass an integer to use any possible returned What'sBest! error number. This is useful in an embedded application of What'sBest!.

<b>Error Codes</b>	<b>Description</b>
<i>Solve_UnmappedDrive</i>	Error on drive
<i>Solve_NoDLL</i>	Error on DLL to access
<i>Solve_BadSolutionStatusArg</i>	Bad SolutionStatus argument
<i>Solve_BadExcelOpenArg</i>	Bad ExcelOpen argument
<i>Solve_MultipleMaxMinError</i>	More than one cell is specified as the objective cell
<i>Solve_ProtectedWorkbookError</i>	Protection can not be on the workbook, only on worksheets
<i>Solve_ReadLINDOWBRCEError</i>	Error reading temporary file LINDOWBRC.TXT
<i>Solve_SaveTempFileError</i>	Error saving a copy of the active workbook
<i>Solve_SymbolInSheetNameError</i>	Error on sheet name
<i>Solve_MinimumFileFormatError</i>	The active workbook must be an Excel® 8.0 (BIFF8 or Excel® 97) format or higher
<i>Solve_UnableToLoadSolverError</i>	There was a problem loading the What'sBest! solver
<i>Solve_ErrorRunningSolver</i>	There was a problem running the What'sBest! solver

**Return Value:** The return value is the same of the Solution Status argument.

**Example:**

```

Sub JustSolve
    On Error goto errorhandler
    Dim lngSolutionStatus as Long
    'Solve the current model
    wbSolve lngSolutionStatus
    'Display the results
    Select Case lngSolutionStatus
        Case 1
            MsgBox "The model is: Globally Optimal"
        Case 2
            MsgBox "The model is: Globally Optimal, " & _
                Range("WBMAX")
        Case 3
            MsgBox "The model is: Infeasible"
        Case 4
            MsgBox "The model is: Unbounded"
        Case 5
            MsgBox "The model is: Feasible"
        Case 6
            MsgBox "The model is: Infeasible or Unbounded"
        Case 7

```

```

        MsgBox "The model is: Near Optimal"
    Case 8
        MsgBox "The model is: Locally Optimal"
    Case 9
        MsgBox "The model is: Locally Infeasible"
    Case 10
        MsgBox "The model is: Cutoff"
    Case 11
        MsgBox "The model is: Numerical Error"
    Case 12
        MsgBox "The model is: Unknown"
    Case 13
        MsgBox "The model is: Unloaded"
    Case 14
        MsgBox "The model is: Loaded"
    Case Else
        MsgBox "Solution status unknown"
    End Select
Exit Sub
ErrorHandler:
Msgbox "Error number is " & Err & ", Description: "
    wbError(Err)
End Sub

```

### ***wbStochasticChanceConstrained***

This routine can be used to set the stochastic support functions seen in the *Stochastic Support* dialog box, at the Chance-Constrained page. All arguments are required, except for the error code, but a 0 value can be placed for unnecessary arguments. For additional discussion of the options available through this routine, see the section entitled *Options...|Stochastic Solver*.

#### Syntax:

*wbStochasticChanceConstrained*(FunctionName, Percent, ObjWeight, Refers\_to, Place\_in\_cell, [NoErrDialog])

<b>Argument</b>	<b>Required</b>	<b>Default</b>	<b>Description</b>
<i>FunctionName</i>	Yes	"WBSP_CC_LT"	FunctionName is a string argument indicating the name of the function to implement, either WBSP_CC_LT or WBSP_CC_GT.
<i>Percent</i>	Yes	0	Percent is an integer between 0 and 1 indicating the wether the probability of the set is satisfied.



<i>ObjWeight</i>	Yes	0	ObjWeight is a number indicating the amount set on the objective value.
<i>Refers_to</i>	Yes	0	Refers_to is the range or address of the cell to copy the chance constraint function.
<i>Place_in_cell</i>	Yes	0	Place_in_cell is a cell reference to specify the cell in which to write the WBSP_ function.
<i>NoErrDialog</i>	No	0	Any argument passed here causes all What'sBest! error dialog boxes from the wbStochasticChanceConstrained routine to be suppressed. Instead, the error number is delivered in this return argument. Pass an integer to use any possible returned What'sBest! error number. Useful in an embedded application of What'sBest!

<b>Error Codes</b>	<b>Description</b>
<i>Sto_BadFunctionNameArg</i>	Bad FunctionName argument
<i>Sto_BadPercentArg</i>	Bad Percent argument
<i>Sto_BadObjWeightArg</i>	Bad ObjWeight argument
<i>Sto_BadRefersToArg</i>	Bad RefersTo argument
<i>Sto_BadPlaceInCellArg</i>	Bad PlaceInCell argument

Examples:

To set a Chance-Constrained information to constraint cells, the simplest syntax would be:  
 wbStochasticChanceConstrained "WBSP\_CC\_LT", 0.8, 0, "A2:B3", "D4", 0

## ***wbStochasticFunction***

This routine can be used to set the stochastic support functions seen in the *Stochastic Support* dialog box. All arguments are required, except for the error code, but a 0 value can be placed for unnecessary arguments. For additional discussion of the options available through this routine, see the section entitled *Options...|Stochastic Solver*.

**Syntax:** `wbStochasticFunction(FunctionName, Stage, CellRange1, CellRange2, CellRange3, Refers_to, Place_in_cell, [NoErrDialog])`

<b>Argument</b>	<b>Required</b>	<b>Default</b>	<b>Description</b>
<i>FunctionName</i>	Yes	"WBSP_..."	FunctionName is a string argument indicating the name of the function to implement.
<i>Stage</i>	Yes	0	Stage is an integer between 1 and 255 indicating the stage the cell belongs to.
<i>CellRange1</i>	Yes	0	CellRange1 is a cell reference for indicating the value of the first argument; used for distributions.
<i>CellRange2</i>	Yes	0	CellRange2 is a cell reference for indicating the value of the first argument; used for distributions.
<i>CellRange3</i>	Yes	0	CellRange3 is a cell reference for indicating the value of the first argument; used for distributions.
<i>Refers_to</i>	Yes	0	Refers_to is the range or address of the cell to copy the stochastic function.
<i>Place_in_cell</i>	Yes	0	Place_in_cell is a cell reference to specify the cell in which to write the WBSP_ function.
<i>NoErrDialog</i>	No	0	Any argument passed here causes all What'sBest! error dialog boxes from the wbStochasticFunction routine to be suppressed. Instead, the error number is delivered in this return argument. Pass an integer to use any possible returned What'sBest! error number. Useful

			in an embedded application of What'sBest!.
--	--	--	--

<b>Error Codes</b>	<b>Description</b>
<i>Sto_BadFunctionNameArg</i>	Bad FunctionName argument
<i>Sto_BadStageArg</i>	Bad Stage argument
<i>Sto_BadCellRange1Arg</i>	Bad CellRange1 argument
<i>Sto_BadCellRange2Arg</i>	Bad CellRange2 argument
<i>Sto_BadCellRange3Arg</i>	Bad CellRange3 argument
<i>Sto_BadRefersToArg</i>	Bad RefersTo argument
<i>Sto_BadPlaceInCellArg</i>	Bad PlaceInCell argument
<i>Sto_BadCellRange1CellRange2Arg</i>	Bad CellRange1CellRange2 argument
<i>Sto_BadCellRange1CellRange2CellRange3Arg</i>	Bad CellRange1CellRange2CellRange3 argument

Examples:

To set a stage information to a variable cell, the simplest syntax would be:

```
wbStochasticFunction "WBSP_VAR", 1, 0, 0, 0, "A2", "A3", 0
```

To set a distribution to a random cell:

```
wbStochasticFunction "WBSP_DIST_LOGNORMAL", 0, "C2", "D2", 0, "A2", "A3", 0
```

---

### ***wbStochasticHistogram***

This routine can be used to set the stochastic histogram seen in the Stochastic Support dialog box. All arguments are required, except for the error code. For additional discussion of the options available through this routine, see the section entitled *Options...|Stochastic Solver*.

Syntax: wbStochasticHistogram(NumberBins, Arglist, Place\_in\_cell, [NoErrDialog])

<b>Argument</b>	<b>Required</b>	<b>Default</b>	<b>Description</b>
NumberBins	Yes	0	<i>NumberBins</i> is an integer between 1 and 255 indicating the number of bins for the reporting cell.
ArgList	Yes	0	<i>ArgList</i> is a listing of cell

---

			references for indicating the cells to display in the stochastic report.
Place_in_cell	Yes	0	Place_in_cell is a cell reference to specify the cell in which to write the WBSP_HIST function.
NoErrDialog	No	0	Any argument passed here causes all What'sBest! error dialog boxes from the wbStochasticHistogram routine to be suppressed. Instead, the error number is delivered in this return argument. Pass an integer to use any possible returned What'sBest! error number. Useful in an embedded application of What'sBest!.

<b>Error Codes</b>	<b>Description</b>
<i>Sto_BadNumberBinsArg</i>	Bad NumberBins argument
<i>Sto_BadArgListArg</i>	Bad ArgList argument
<i>Sto_BadPlaceInCellArg</i>	Bad PlaceInCell argument
<i>Sto_ProtectedSheetRepError</i>	Bad ProtectedSheetRep argument

Examples:

To set several reporting cells, so to display the histogram report, the simplest syntax would be:

```
wbStochasticHistogram 0, "Sheet1!$C$1"
```

***wbStochasticReport***

This routine can be used to set the stochastic reporting cells seen in the *Stochastic Support* dialog box. All arguments are required, except for the error code. For additional discussion of the options available through this routine, see the section entitled *Options...|Stochastic Solver*.

Syntax: wbStochasticReport(ArgList, Place\_in\_cell, [NoErrDialog])

<b>Argument</b>	<b>Required</b>	<b>Default</b>	<b>Description</b>
<i>ArgList</i>	Yes	0	ArgList is a listing of cell

			references for indicating the cells to display in the stochastic report.
<i>Place_in_cell</i>	Yes	0	<i>Place_in_cell</i> is a cell reference to specify the cell in which to write the WBSP_REP function.
<i>NoErrDialog</i>	No	0	Any argument passed here causes all What'sBest! error dialog boxes from the <i>wbStochasticFunction</i> routine to be suppressed. Instead, the error number is delivered in this return argument. Pass an integer to use any possible returned What'sBest! error number. Useful in an embedded application of What'sBest!.

<b>Error Codes</b>	<b>Description</b>
<i>Sto_BadArgListArg</i>	Bad ArgList argument
<i>Sto_BadPlaceInCellArg</i>	Bad PlaceInCell argument
<i>Sto_ProtectedSheetRepError</i>	Bad ProtectedSheetRep argument

Examples:

To set several reporting cells, so to display the stochastic report, the simplest syntax would be:

```
wbStochasticReport "Sheet1!$B$1:$B$3,Sheet1!$C$1", "A1", 0
```

---

### **wbStochasticStageScenario**

This routine can be used to set the stochastic stage/scenario table seen in the *Stochastic Support* dialog box. All arguments are required, except for the error code. For additional discussion of the options available through this routine, see the section entitled *Options...|Stochastic Solver*.

Syntax: *wbStochasticStageScenario*(CellRange1, Place\_in\_cell, RangeChoice, [NoErrDialog])

<b>Argument</b>	<b>Required</b>	<b>Default</b>	<b>Description</b>
<i>CellRange1</i>	Yes	0	<i>CellRange1</i> is a cell reference for indicating the range of the table.
<i>Place_in_cell</i>	Yes	0	<i>Place_in_cell</i> is a cell reference to specify the cell in which to write the WBSP_STSC function.

---

<i>RangeChoice</i>	Yes	0	RangeChoice is a string "SET" to enter the function, or "NONE" to delete the selected cell.
<i>NoErrDialog</i>	No	0	Any argument passed here causes all What'sBest! error dialog boxes from the wbStochasticFunction routine to be suppressed. Instead, the error number is delivered in this return argument. Pass an integer to use any possible returned What'sBest! error number. Useful in an embedded application of What'sBest!.

<b>Error Codes</b>	<b>Description</b>
<i>Sto_BadCellRange1Arg</i>	Bad CellRange1 argument
<i>Sto_BadPlaceInCellArg</i>	Bad PlaceInCell argument
<i>Sto_BadRangeChoiceArg</i>	Bad RangeChoice argument

Examples:

To set a Stage/Scenario table, the simplest syntax would be:

```
wbStochasticStageScenario "Sheet1!$B$1:$C$3", "D1", "SET", 0
```

---

## ***wbUpdateLinks***

For additional discussion of the functionality provided by this routine, see the description of *Update Links* in the section entitled *Options...|General*.

This routine is used to update the links to the WB constraints and functions.

Syntax: wbUpdateLinks()

The *wbUpdateLinks* procedure has no arguments.

<b>Error Codes</b>	<b>Description</b>
<i>UpdateLinksProtectedError</i>	Unable to update links on a protected sheet
<i>UpdateLinksHiddenError</i>	Unable to determine if there are constraints in hidden cells on protected sheets

Remarks: This procedure is provided because Excel® does not properly update links of add-in functions.

---

---

# 5 Functions and Operators

---

What'sBest! supports many mathematical and logical functions of Excel® and also adds some functions of its own.

---

## List of Supported Functions and Operators

The following Excel® functions and operators are supported by What'sBest!.

### Functions

ABS*	ACOS	ACOSH	AND*
ASIN	ASINH	ATAN	ATAN2
ATANH	AVERAGE	BINOMDIST	CHIDIST
CHIINV	COS	COSH	EXP
EXPONDIST	FALSE	FDIST	FINV
GAMMADIST	GAMMAINV	HLOOKUP**	HYPGEOMDIST
IF*	INT*	LN	LOG***
LOGINV	LOGNORMDIST	MAX*	MIN*
MOD*	MMULT	NEGBINOMDIST	NORMDIST
NORMINV	NORMSDIST	NORMSINV	NOT*
NPV	OR*	PI	POISSON
PRODUCT	PV		
ROUND*	ROUNDDOWN*	ROUNDUP*	
SIGN*	SIN	SINH	SQRT
SUM	SUMIF**	SUMPRODUCT	
TAN	TANH	TRANSPOSE	TRUE
TRUNC*			
VLOOKUP**			
WBERLANG_B	WBERLANG_C	WBEXPOINV	WBINNERPRODUCT***
WBLOGISTIC	WBLOGISTICDENS	WBLOGISTICINV	WBMULTINV
WBNORMSL	WBTRIAINV	WBUNIFINV	WEIBULL

### Operators

^	/	=*
*	<*	>*
+	<=*	>=*
-	<>	%

\* The function is non-smooth. Its use may result in long solution times, and if the Global Solver is not used, non-optimal solutions. See the discussion of *Smoothness* in *Overview of Mathematical Modeling*.

\*\* These functions are supported only under certain conditions. Refer to the sections *Function SUMIF*, or *Function VLOOKUP (HLOOKUP)* for specifics.

\*\*\* *WBINNERPRODUCT* is a function supplied with *What'sBest!*. This function is the equivalent of *SUMPRODUCT*, but instead of multiplying terms row by row, the terms are multiplied row by column.

\*\*\*\* *LOG* can support one argument assuming base 10, or two arguments.

## *Distributions/Correlations for Stochastic Programming*

Refer to the section Options...|Stochastic Solver for additional explanation on using these functions.

### ***Distributions***

*W BSP\_DIST\_BETA*      *W BSP\_DIST\_BINOMIAL*

*W BSP\_DIST\_CAUCHY*      *W BSP\_DIST\_CHISQUARE*

*W BSP\_DIST\_DISCRETE\_SH*      *W BSP\_DIST\_DISCRETE\_SV*

*W BSP\_DIST\_DISCRETE\_SH\_W*      *BSP\_DIST\_DISCRETE\_SV\_W*

*W BSP\_DIST\_EXPONENTIAL*

*W BSP\_DIST\_F\_DISTRIBUTION*

*W BSP\_DIST\_GAMMA*      *W BSP\_DIST\_GUMBEL*

*W BSP\_DIST\_GEOMETRIC*

*W BSP\_DIST\_HYPERGEOMETRIC*

*W BSP\_DIST\_LAPLACE*      *W BSP\_DIST\_LOGARITHMIC*      *W BSP\_DIST\_LOGISTIC*

*W BSP\_DIST\_LOGNORMAL*

*W BSP\_DIST\_NEGATIVEBINOMIAL*      *W BSP\_DIST\_NORMAL*

*W BSP\_DIST\_PARETO*      *W BSP\_DIST\_POISSON*

*W BSP\_DIST\_STUDENTS\_T*      *W BSP\_DIST\_SYMMETRICSTABLE*

*W BSP\_DIST\_TRIANGULAR*

*W BSP\_DIST\_UNIFORM*

*W BSP\_DIST\_WEIBULL*

### ***Correlations***

*W BSP\_CORR\_KENDALL*      *W BSP\_CORR\_PEARSON*      *W BSP\_CORR\_SPEARMAN*



## Linearization

Many of the non-smooth functions and operators supported by *What'sBest!* may be automatically smoothed by the solver through a process referred to as *linearization*. Linearization replaces a non-smooth function or operator with a collection of additional linear variables and constraints such that the modified model is mathematically equivalent to the original with the non-smooth functions or operators eliminated. Non-smooth functions and operators that may be eliminated through linearization are:

### FUNCTIONS OPERATORS

<i>ABS</i>	<
<i>AND</i>	<=
<i>HLOOKUP</i>	<>
<i>IF</i>	=
<i>INT</i>	<
<i>MAX</i>	>=
<i>NOT</i>	
<i>OR</i>	
<i>SIGN</i>	
<i>SUMIF</i>	
<i>VLOOKUP</i>	

In addition to the above, *What'sBest!* can also linearize products of 0/1 and continuous variables.

For more information on the linearization process, refer to the section entitled *Options...|General*.

## Global Solver

Functions currently supported are:

- 1) Standard smooth functions:  $x+y$ ,  $x-y$ ,  $x*y$ ,  $\log(x)$ ,  $\exp(x)$ ,  $\sqrt{x}$ ,  $\sin(x)$ ,  $\cos(x)$
- 2) Continuous, non-smooth:  $\text{abs}(x)$ ,  $\text{max}(x,y)$ ,  $\text{min}(x,y)$
- 3) Smooth, not quite continuous:  $x/y$ ,  $x^y$ ,  $\tan(x)$ ,  $\text{floor}(x)$
- 4) Logical and relational operators:  $\text{if}(x,y,z)$ ,  $>=$ ,  $<=$ ,  $==$ ,  $!=$ ,  $\text{.AND.}$ ,  $\text{.OR.}$ ,  $\text{.NOT.}$
- 5) Probability distributions:  $\text{psn}(z)$  [Normal Distribution],  $\text{psl}(z)$  [Normal Linear Loss]

# Statistical Functions

What'sBest! supplies six built-in statistical functions. These functions can be used within your What'sBest! models as if they were native supported functions in your spreadsheet (e.g., *SUM*, *SUMPRODUCT*, *ABS*, etc.). You should precede the spreadsheet function name with '='. For example, enter the inverse triangular cumulative distribution distribution as `=WBTRIINV(1, 3, 2, 0.7)`.

## 1. Erlang's Loss of Probability - *WBERLANG\_B*

This is Erlang's loss probability for a service system with X servers and an arriving load of A, no queue allowed. The result of *WBERLANG\_B*(A, X) can be interpreted as either the fraction of time all servers are busy or the fraction of customers lost due to all servers being busy when they arrive. It is extended to non-integer values of X by linear interpolation. The arriving load A is the expected number of customers arriving per unit of time multiplied by the expected time to process one customer.

### *WBERLANG\_B*(Load, Num\_Servers)

<i>Load</i>	<i>Load</i> must be a non-negative real number.
<i>Num_Servers</i>	<i>Num_Servers</i> must be a strictly positive integer.

## 2. Erlang's Busy Probability - *WBERLANG\_C*

This is Erlang's busy probability for a service system with X servers and an arriving load of A, with infinite queue allowed. The result of *WBERLANG\_C*(A, X) can be interpreted as either the fraction of time all servers are busy or the fraction of customers that must wait in the queue. It is extended to non-integer values of X by linear interpolation. The arriving load A is the expected number of customers arriving per unit of time multiplied by the expected time to process one customer.

### *WBERLANG\_C*(Load, Num\_Servers)

<i>Load</i>	<i>Load</i> must be a non-negative real number.
<i>Num_Servers</i>	<i>Num_Servers</i> must be a strictly positive integer.

### 3. Inverse Exponential Cumulative Distribution - *WBEXPONV*

This function returns the inverse of an exponential cumulative distribution for a supplied mean and standard deviation. The syntax is:

***WBEXPONV(Prob, Mean)***

<i>Prob</i>	The probability corresponding to the exponential distribution. The probability must be greater-than-or-equal-to 0 and less-than-or-equal-to 1.
<i>Mean</i>	The arithmetic mean of the distribution. The mean must be greater-than-or-equal-to zero.

For example, *WBEXPONV(.5,1)* returns 0.69315. This means that for an exponential distribution with mean 1.0, 50 percent of the outcomes are less-than-or-equal-to 0.69315.

### 4. Inner Sum Product - *WBINNERPRODUCT*

This function is the equivalent of *SUMPRODUCT*, but instead of multiplying terms row by row the terms are multiplied row by column and then summed. The syntax is:

***WBINNERPRODUCT(Range1, Range2)***

<i>Range1</i> or <i>Range2</i>	The cell range containing the column or row to multiply and sum. <i>Range1</i> and <i>Range2</i> can only be one dimensional ranges and the ranges must be the same size and shape.
-----------------------------------	---

**Note:** Nesting of the *WBINNERPRODUCT* function is not recommended. In other words, the function *WB(A1,"<=","WBINNERPRODUCT(B2:B4,A3:A5))* should be avoided.

### 5. Logistic, Cumulative Distribution - *WBLOGISTIC*

This function returns the cumulative distribution function for the Logistic distribution. The syntax is:

***WBLOGISTIC(A, B, C)***

<i>A, B, C</i>	Cumulative distribution function for the Logistic distribution with location parameter A and scale parameter B. It returns the probability that an observation from this distribution is less than or equal to C.
----------------	---

**6. Logistic, Probability Density Distribution - WBLOGISTICDENS**

This function returns the probability density function for the Logistic distribution. The syntax is:

***WBLOGISTICDENS(A, B, C)***

<i>A, B, C</i>	Probability density function for the Logistic distribution with location parameter A and scale parameter B. It returns the probability density at C.
----------------	--

**7. Logistic, Inverse Distribution - WBLOGISTICINV**

This function returns the inverse of the Logistic distribution. The syntax is:

***WBLOGISTICINV(A, B, C)***

<i>A, B, C</i>	Inverse of Logistic distribution with input probability C, location parameter A and scale parameter B.
----------------	--

**8. Inverse Multinomial Cumulative Distribution - WBMULTINV**

This function returns the inverse of a multinomial cumulative distribution for a supplied set of probabilities and corresponding values. The syntax is:

***WBMULTINV(Prob, ProbRange, ValueRange)***

<i>Prob</i>	The probability corresponding to the multinomial distribution. The probability must be greater-than-or-equal-to 0 and less-than-or-equal-to 1.
<i>ProbRange</i>	The cell range containing the probabilities. ProbRange must be a one-dimensional range (i.e., a range of cells in either a single row or a single column).
<i>ValueRange</i>	The cell range containing the values that correspond with each probability. The ValueRange must be the same size and shape as the ProbRange.

For example, given the following:

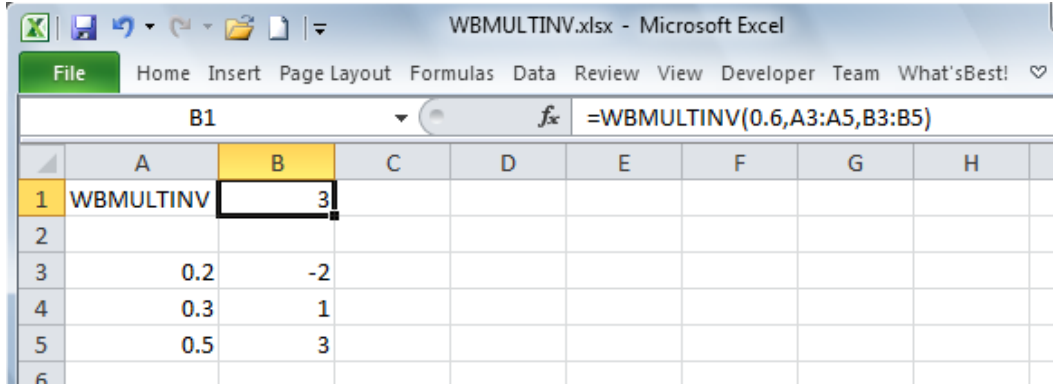

then  $WBMULTINV(0.6,A3:A5,B3:B5)$  returns 3. This means that the minimum outcome  $X$ , such that 60 percent of the outcomes are less-than-or-equal-to  $X$ , is  $X=3$ .

### 9. Standard Normal Linear Loss Function - *WBNORMSL*

This function returns the expected value of  $\max \{0, Z-X\}$ , where  $Z$  is a standard normal random variable. In inventory modeling,  $WBNORMSL(X)$  is the expected amount that demand exceeds a level  $X$ , if demand has a normal distribution. The syntax is:

***WBNORMSL(Value)***

<i>Value</i>	Value must be a real number.
--------------	------------------------------

### 10. Inverse Triangular Cumulative Distribution - *WBTRIINV*

This function returns the inverse of a triangular cumulative distribution for supplied low, mode, and high values. The syntax is:

***WBTRIINV(Low, High, Mode, Prob)***

<i>Low</i>	The lower limit of the triangular distribution.
<i>High</i>	The upper limit of the distribution. High must be greater-than-or-equal-to Mode.
<i>Mode</i>	The mode (peak value) of the distribution. Mode must be between the Low and High values.
<i>Prob</i>	The probability corresponding to the triangular distribution. The probability must be greater-than-or-equal-to 0 and less-than-or-equal-to 1.

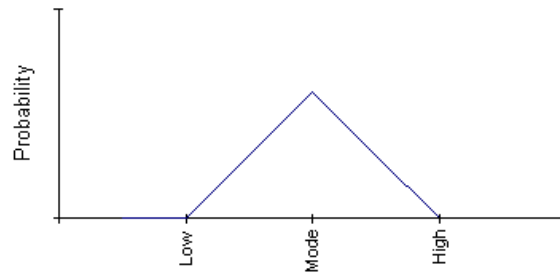

For example,  $WBTRIAINV(1, 3, 2, 0.7)$  returns 2.2254. This means that for a triangular distribution over the range [1,3] with mode 2, 70 percent of the outcomes are less-than-or-equal-to 2.2254.

### 11. Inverse Uniform Cumulative Distribution - $WBUNIFINV$

This function returns the inverse of a uniform cumulative distribution for supplied low and high values. The syntax is:

**$WBUNIFINV(Prob, Low, High)$**

<i>Prob</i>	The probability corresponding to the uniform distribution. The probability must be greater-than-or-equal-to 0 and less-than-or-equal-to 1.
<i>Low</i>	The lower limit of the uniform distribution.
<i>High</i>	The upper limit of the uniform distribution. <i>High</i> must be greater-than-or-equal-to <i>Low</i> .

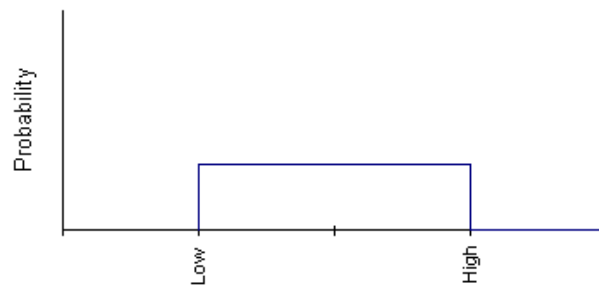

For example,  $WBUNIFINV(.4, 1, 2)$  returns 1.4. This means that for a uniform distribution on the interval [1,2], 40 percent of the outcomes are less-than-or-equal-to 1.4.

---

# 6 Overview of Mathematical Modeling

---

## Introduction

The relationships in your model influence the computation time, the solution methods used by *What'sBest!*, and the type of solution returned. This overview very briefly explains some of the different types of expressions entailed and explores how the expression type affects the solution search. An understanding of these basic principles is not required to use *What'sBest!*, but it can go a long way in helping you to use the software more effectively.

In the section entitled *Linear vs. Nonlinear Expressions and Linearization*, we consider the two expression types, linear and nonlinear, and how they influence the solution process. The section entitled *The Solution Process: Determining optima* introduces some of the issues in finding optima. These issues include local versus global optima and the distinction between smooth (continuous) and non-smooth (non-continuous) functions. The type of outcomes generated by *What'sBest!* is discussed in the section entitled *Solution Outcomes*. Finally, some suggestions for modeling are offered in the last section *Guidelines for Modeling with What'sBest!* and *Guidelines for Stochastic Modeling*.

---

## Linear vs. Nonlinear Expressions and Linearization

Mathematical expressions can be classified according to their characteristics. The broadest and most common distinction is between linear and nonlinear expressions. *What'sBest!* analyzes your model and describes it as linear or nonlinear in the status report under *Model Type*.

### Linear Expressions

If all the terms of an equation are of the first order, the expression is said to be linear. This means the expression doesn't contain a variable squared, cubed, or taken to any power other than one, a term divided by a variable, or variables multiplied by each other. In other words, proportionality exists. That is, for every unit increase or decrease in a variable, the expression increases or decreases by a fixed amount.

In their simplest form, linear formulas are "straight line" relationships. For example, suppose you're buying tomatoes for \$1.50 per pound. The expression or function used to calculate the *Cost* ( $C$ ) in terms of the amount of tomatoes purchased ( $T$ ) is:

$$C = 1.5 * T$$

As you might expect, a graph of this expression for cost is a straight line:

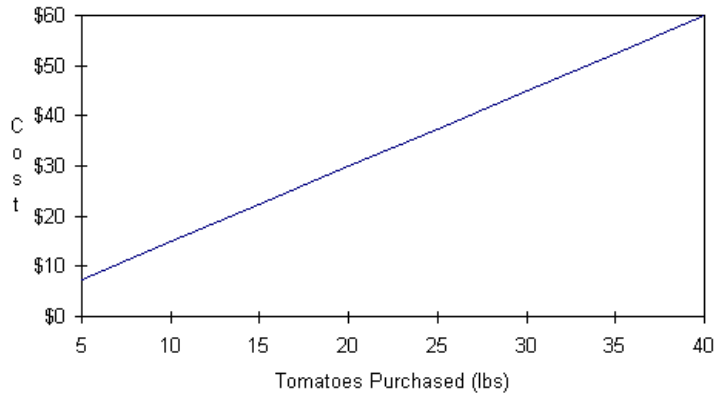

Linear expressions can have multiple variables. For example, if you added potatoes ( $P$ ) at \$0.75 per pound and apples ( $A$ ) at \$1.25 per pound, your cost function would become:

$$C = 1.5 * T + 0.75 * P + 1.25 * A$$

This new cost expression is linear — you could think of it as the sum of three simpler linear expressions.

## Nonlinear Expressions

By definition, all expressions that are not linear are nonlinear. Nonlinear expressions include relationships in which variables are squared, cubed, or taken to powers other than one, variables that are multiplied by each other, and many expressions using nonlinear spreadsheet functions such as *IF*, *MAX*, and *MIN*.

Models with nonlinear expressions are intrinsically much more difficult to solve than linear models. Unlike linear models, a badly-formulated nonlinear model may prevent *What'sBest!* from finding a solution, even though one in fact exists. Another problem posed by some nonlinear models is that *What'sBest!* may detect a locally-optimal solution to the model that appears to be the "best", whereas a better, but also locally-optimal, solution still exists. For more on what you can do to help minimize the occurrence of these undesirable results, see the section titled *Guidelines for Modeling with What'sBest!*.

## Linearization

The presence of any nonlinear expressions in the model will cause the nonlinear solver to be invoked and the model to be classified as nonlinear. You can determine whether your model is linear or nonlinear by the classification under *Model Type* in the solver status window or the status report. The nonlinear models take much longer to solve than a linear model with the same number of constraints. The process of converting a nonlinear expression to a linear expression is called *linearization*. *What'sBest!* can perform different degrees of linearization in the pre-processing stage of the solution



process on the *ABS*, *IF*, *MAX*, and *MIN* nonlinear spreadsheet functions, as well as all logical operators. See Chapter 6, *Functions and Operators*, for a comprehensive list.

Ideally, all nonlinear expressions would be converted to linear equivalents, so the linear solver can be used instead of the nonlinear solver. For an example of a simple nonlinear-to-linear conversion, consider the following equation:

$$X / Y = 10$$

As written, this equation is nonlinear, because of the division by *Y*. By simply multiplying both sides of the equation through by *Y*, this can be converted to the equivalent linear equation:

$$X = 10 * Y$$

By utilizing as many nonlinear-to-linear conversions as possible, the nonlinear model might possibly be reduced to a linear model. When a nonlinear model can be fully linearized, the payoff can sometimes be enormous (e.g., finding a solution where none could be found before or reducing solution time from days to seconds). The sample model *Linearization Option and Construction Cost Estimation* demonstrates the benefits of successful linearization.

The *What'sBest!* linearization option cannot reduce all nonlinear models to linear models, nor does the effort necessarily improve the solution time. In some exceptional cases, it may be better to run *What'sBest!* with linearization disabled. For this reason, the linearization option is provided with some user-adjustable parameters that are set in the *General Options* dialog box. You may wish to try different degrees of linearization to see what works best for your model.

It is highly recommended that you consider performing linearization on your own. If *What'sBest!* indicates that your model is nonlinear, it can be beneficial to investigate the expressions in the nonlinear cells and determine whether any could be reformulated in a linear manner.

**Note:** The locations of all nonlinear cells will be displayed in the status report, assuming that the *Nonlinearity present* warning has been enabled in the *General Options* dialog box.

## The Solution Process: Determining Optima

### Local Optima vs. Global Optima

Linear and nonlinear problems are distinguishable by their different kinds of solutions. When the *What'sBest!* linear solver finds a solution to a linear optimization model, that solution is a best solution. Such a solution is called a *global optimum* because there is no better feasible solution.

By contrast, conventional nonlinear solvers are only able to identify *local optima* (i.e., solutions for which no better feasible solutions can be found nearby). *What'sBest!* tells you what type of solution you have reached by returning either *Globally Optimal* or *Locally Optimal* in the *Solution Status* field of the status report. If a model is nonlinear and the global solver is not used, then the status will always be locally optimal if a solution is found.

It is a property of nonlinear optimization models that they may have several solutions that are locally optimal. Such locally optimal solutions to nonlinear optimization models cannot be assumed to be

globally optimal. The following example illustrates this property and explains how you might explore the various local optima.

Consider the following model. Cell B3 has been specified as an adjustable cell, B4 has been specified to be minimized and contains the equation  $B3 * \text{SIN}(3.1416 * B3)$ , and B5 contains the constraint  $B4 \leq 6$ .

The following graph shows a plot of B4, the expression to be minimized, for values of B3 between 0 and 6. You can see that, if you're searching for a minimum, there are local optima at B3 values of 0, 1.564, 3.529, and 5.518 — in the "valleys". If you use the global solver, it will find a global optimum for this problem at B3 = 5.518, since that is the last valley before 6.

Graph of  $B3 * \text{SIN}(3.1416 * B3)$

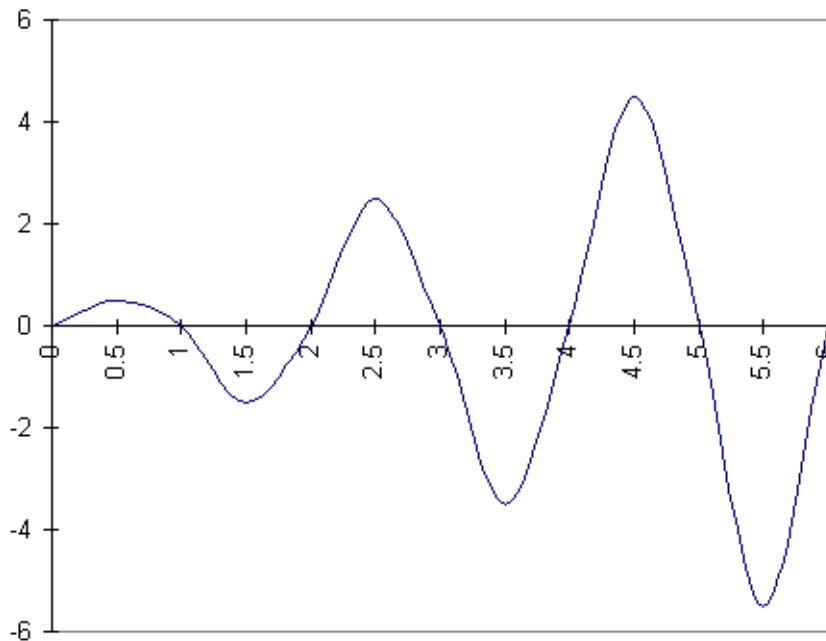

Imagine the graph as a series of hills. You're searching in the dark for the minimum or lowest elevation. If you start your search at B3 = 3, every step to the left takes you uphill and every step right takes you downhill. Therefore, you move to the right in your search for the lowest point. You'll continue to move right as long as this direction leads to lower ground.

When you reach B3 = 3.529, you will notice a small flat area (slope is equal to zero). Continuing to the right begins to lead uphill and retreating to the left leads up the hill you just came down. You are in a valley, the lowest point in the immediate neighborhood (a local minimum), but is it the lowest possible point? You can't determine that given the information available to you at that particular point.

This is an extreme example and not typical of well-formulated nonlinear problems. Nonlinear solvers do their best to tackle such nonlinear models by seeking a local optimum from the starting points supplied by the user. This provides the user with the opportunity to explore the available local optima.

What's*Best!* takes the initial values of the adjustable cells as starting points in its search for a locally optimum solution. Therefore, if you solve this model with different starting values for B3, and do not use the Global Solver, then What's*Best!* may return a different local minimum. Attempting to solve the model with a starting value between 5 and 6 for B3 is likely to lead to a local minimum at 5.518, which happens to be the global optimum. You may try other starting values to find other local optima. For some problems, you may find that observing the results of solving the model several times with different initial values can help you find the best solution.

## Convexity

If a function is convex, then it has a single global optimum. If a function is not convex, it may have multiple local optima. The following example shows a convex function of a single variable:

Graph of  $.4*(A1-3)^2 + .5$

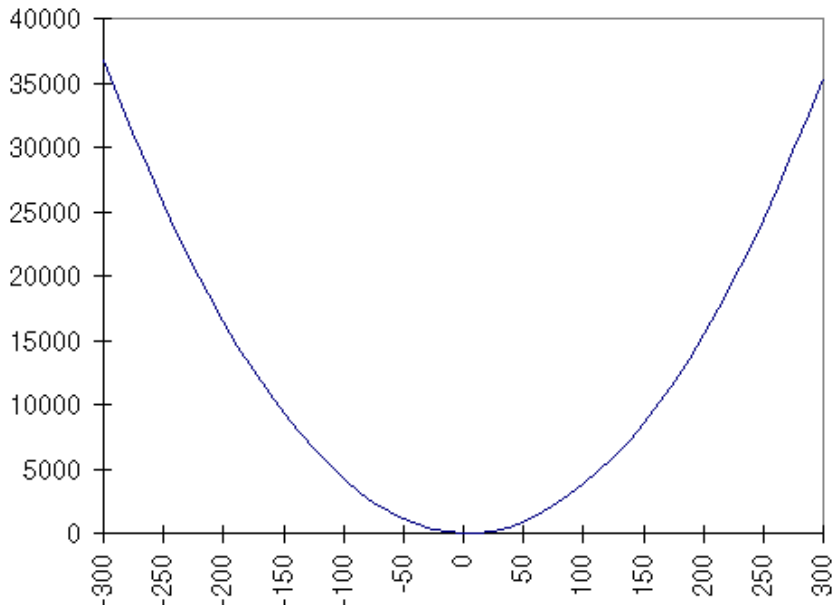

A geometric definition of convexity states that a function is convex if for any two points on or above the function, a straight line connecting the two points lies entirely on or above the function.

As illustrated in the preceding graph, a strictly convex function with no constraints has a single minimum. That is, water drizzled on it will collect in a single puddle at the global minimum. Therefore, minimizing a smooth convex function with no constraints will yield the global optimum regardless of the initial value of the adjustable cells. However, if the function is not convex, there may be more than one local optimum. In this case, the returned answer may be locally optimal, but not globally optimal.

Determining the convexity of a multiple variable problem is no easy task. Mathematicians call a function convex if the matrix of second derivatives is positive definite or has all positive Eigen values. A function is called concave if the matrix of second derivatives is negative definite. A function can be concave in one section and convex in another. The following function is strictly concave:

A Strictly Concave Function: Graph of  $-(A1^2)$

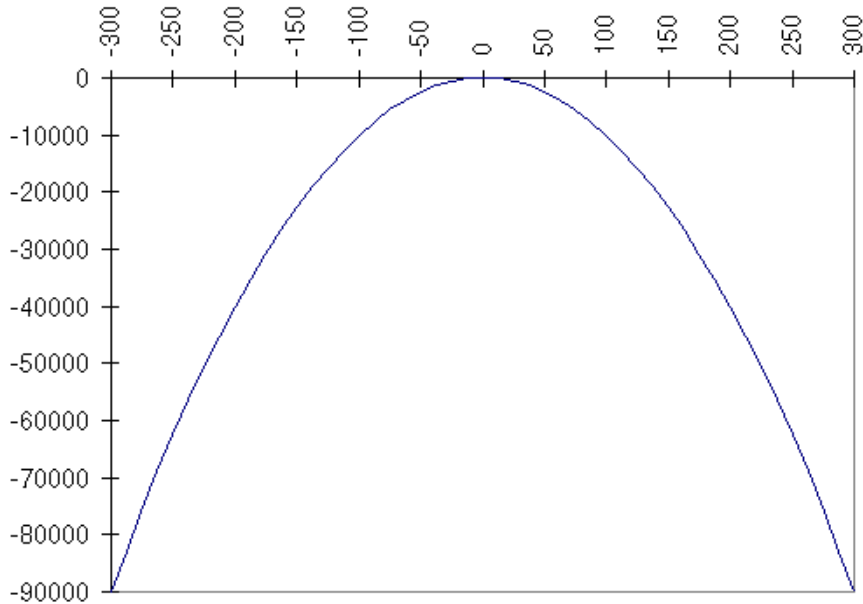

For a mixed function, look back at the graph of  $X * SIN(3.1416 * B3)$  in the preceding section.

## Smooth vs. Non-smooth Expressions

Smooth expressions have a defined first derivative (slope or gradient) at every point. Graphically, a smooth function of a single variable can be plotted as a single continuous line with no abrupt bends or breaks.

Non-smooth expressions include nondifferentiable and discontinuous functions. Expressions having one or more points for which the first derivative is not defined are called nondifferentiable. Graphs of nondifferentiable expressions may have abrupt bends at such points. Taking the absolute value of an adjustable cell,  $ABS(A1)$ , is an example of a nondifferentiable expression. This is illustrated in the following graph:

Graph of  $ABS(A1)$

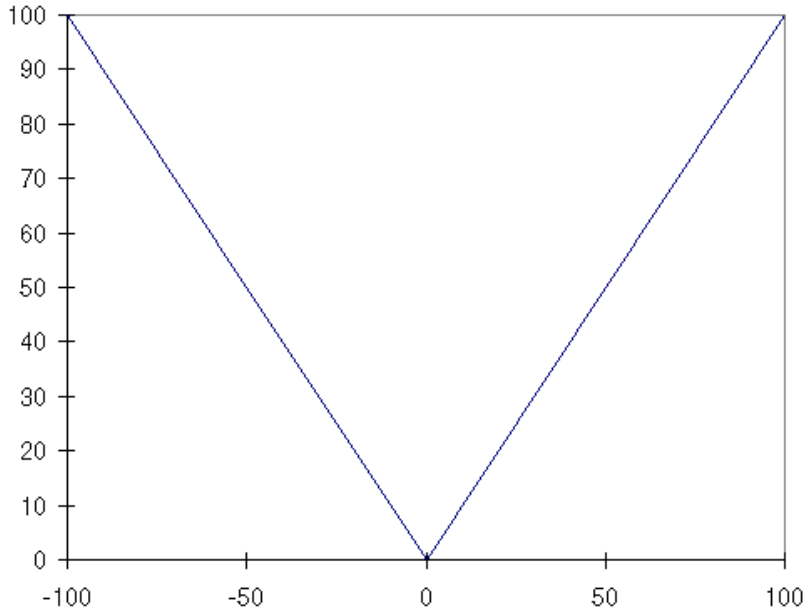

Here, there is an abrupt bend in the graph at the point of zero. This can dramatically increase solution times. Additional non-smooth functions are *MAX* and *MIN*.

Discontinuous functions are even more challenging to a nonlinear solver. Discontinuous functions are expressions whose graphs contain breaks. The spreadsheet *IF* function with adjustable cells as arguments is commonly used to express a discontinuous expression, as in the following:

Graph of  $IF(A1>0,A1^2,A1^2+100)$

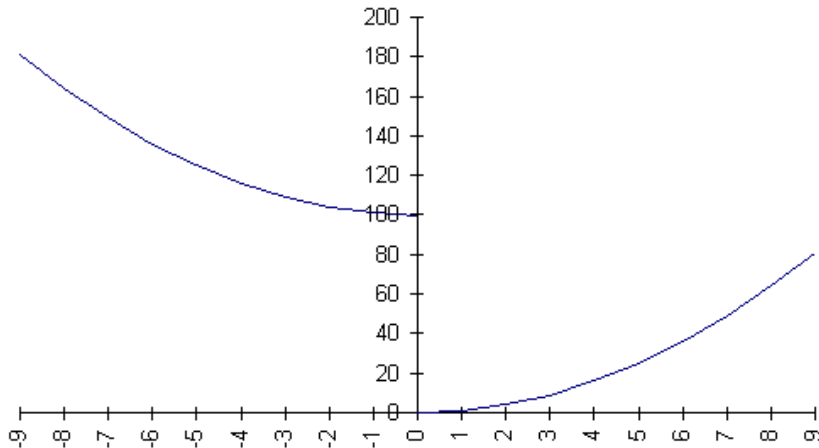

---

In simplified terms, *What'sBest!* searches along the plot of the expression to find a maximum or minimum point representing an optimal solution. Breaks and sharp bends on the plots of non-smooth functions pose challenges to the solver not posed by smooth continuous functions. It is a good practice to avoid formulating your problem with non-smooth functions.

---

## Solution Outcomes

The solution and analysis of the outcome of the solution process is presented in the status report worksheet. The status report worksheet is inserted following the completion of the solution process—unless you have disabled the status report (regarding disabling reports, see the *Reports, Location and Warnings* box on the *General Options* dialog box posted by the *Options...|General* command). The status report is opened by clicking the *WB! Status* tab among your Excel® worksheets.

Unless you have imposed a limit on the number of iterations in the solution search or have interrupted the solver by pressing the *Hold/Interrupt* button on the *What'sBest!* solver status window, the message provided in the field *Solution Status* in the status report should be one of those listed below.

### Case 1: Optimization Models

If a cell has been specified to be maximized or minimized, there are several possible outcomes of an attempt to solve the model:

#### Globally Optimal

During the solution search, the solver found the best possible solution that satisfies all the constraints. The message *Solution Status: GLOBALLY OPTIMAL* will be displayed in the status report upon successful solution of a linear model. There is no better answer that satisfies all constraints.

#### Locally Optimal

A locally optimal outcome applies to a nonlinear model when the solver has found the best solution within a local area that satisfies all of the constraints. In other words, no better solution exists within that local area. This means it is possible there is a locally optimal solution outside this immediate area that provides a better answer. It may be wise to consider re-solving the model with different starting values for the adjustable cells in attempting to investigate other local optima.

#### Optimality Conditions in Nonlinear Models

After successfully solving a nonlinear model, in addition to reporting a solution status of locally optimal, the status report also indicates whether the optimality conditions are *SATISFIED* or *UNCERTAIN*. A mathematician might refer to these optimality conditions as the Kuhn-Tucker conditions. A layman, on the other hand, might prefer to think of the optimality conditions as the "flatness" conditions.

Geometrically, for functions with no constraints, satisfaction of the optimality conditions means the objective function is flat (the slope is zero) in the neighborhood of the returned solution (i.e., it is at the top of the peak or bottom of the valley). Algebraically, it means that, for each variable, the partial

---

---

derivative is zero. Explaining these conditions on models with constraints lies beyond the scope of this help file. It suffices to say that the interpretation can be generalized to constrained models.

There are two primary reasons for the optimality conditions to be reported as uncertain. First, if the optimum (best cell value) lies at a discontinuity or a point where the objective function is non-smooth, the slope is undefined. At a point for which the slope is undefined, the optimality conditions cannot be said to be satisfied – hence they are determined uncertain. Second, if in the search for a solution *What'sBest!* completes several iterations without making any significant improvement in the objective function, it will stop even though the optimality conditions are not satisfied. This may be a situation in which the objective function is very nearly flat over an unusually large region.

Whether the optimality conditions are satisfied or uncertain, if the solution is locally optimal, then another local optimum may exist that improves on the current solution. Even though the mathematical conditions to prove optimality may be inconclusive, the value returned in the best cell is locally optimal. Therefore, you should always consider re-solving the model with different values for the adjustable cells to see whether another local optimum improves the solution.

### No Feasible Solution Found

The message *Solution Status: INFEASIBLE* is displayed in the status report if *What'sBest!* was unable to find a solution that satisfied all the constraints. If the model is linear, then there is no answer that satisfies all constraints. If the model is nonlinear, then either no feasible answer exists or a feasible answer exists, but *What'sBest!* was unable to find it. For details, please see the topic *Solution Status: No Feasible Solution*.

### Unbounded

The message *Solution Status: UNBOUNDED* is returned if, without violating any constraints, the value of the cell to be minimized can be decreased without limit or the value of the cell to be maximized can be increased without limit. For details, please see the topic *Solution Status: UNBOUNDED*.

### Numerical Error

The message *Solution Status: NUMERICAL ERROR* is returned if there was a serious error. For details, please see the topic *Solution Status: NUMERICAL ERROR*.

## Case 2: Non-optimization Models

If no best cell has been specified (i.e., there is no objective function), there are only two possible outcomes of an attempt to solve the model. *What'sBest!* either finds a feasible solution or reports that a feasible solution was not found. As with nonlinear optimization models, if the model is nonlinear, there may be a feasible solution that *What'sBest!* was unable to find. You may want to consider re-solving with different initial values in the adjustable cells.

---

# Guidelines for Modeling with What'sBest!

## General Modeling Guidelines

An example showing how to build a simple linear model is provided in the *Tutorial in Getting Started*. In addition, the *Sample Models* demonstrate how linear and nonlinear models can be constructed for a variety of applications. As you construct your own model, it may be useful to periodically solve the model and check the status report to determine the type of model you have (linear/nonlinear) and its characteristics. In general, linear models are the fastest group of models to solve and nonlinear models are the most difficult to solve. It is not unusual that a nonlinear model will take many times longer to solve than a linear model with the same number of variables.

If a linear or nonlinear model is close to a solution (i.e., constraints are only slightly violated) then increasing one of the feasibility tolerances may allow you to reach a solution. Tolerances are set in both the *Linear Solver Options* and *Nonlinear Solver Options* dialog boxes.

For a difficult linear model, the options provided in the *Linear Solver Options* dialog box may help you to reach a solution or shorten the solution time. One of the first options you might try is turning on (or off) *Model Reduction*. Some linear problems will solve faster by a different *Solver Method*. The *Barrier* method may be considerably faster on big models, while the two simplex methods will tend to be faster on smaller, sparse models.

Large integer problems can be very difficult to solve and take a great deal of time arriving at a solution. To solve an infeasible problem or to shorten the solution time, you can try various options on the *Integer Solver Options* dialog box. Setting an *Optimality Tolerance* can improve run times dramatically if you are happy being within a certain percentage of the optimal solution. Some problems solve faster when the *Branching Direction* is set to *Up*. Setting the *Application* of the *Constraint Cuts to All Nodes* may help solve some problems. Setting the *Probing Levels* may also help shorten solution time. We recommend setting to a level of three or lower.

Nonlinear problems are generally difficult to solve. Setting a *Feasibility Tolerance* or *Optimality Tolerance* may help you to reach a solution. Trying different *Strategies* may also be useful to reaching a solution.

Many nonlinear problems are made unnecessarily difficult or slow to solve by the presence of nonlinear expressions that could be rewritten in linear form. The *Linearization* option is a tool for automatically rewriting these nonlinear expressions in linear form. Linearization can be a great performance boost if all nonlinear formulas in a model can be linearized, such that the final model becomes totally linear. If linearization can only be applied to a subset of the nonlinear formulas, then performance may erode.

The options described above for solving nonlinear problems are important aids to solving nonlinear problems. However, if the problem is poorly-formulated, then the options can only help alleviate the effects of poor formulation. The following section provides some suggestions for good formulation of nonlinear problems.

---



## Nonlinear Modeling Guideline

Nonlinear models can be extremely complex to solve. It can pay off in terms of solution speed and reliability to spend a little extra time to make sure the model is formulated in a way that is most efficient to solve. This section gives some general guidelines to consider when building and solving nonlinear models.

### Supply Good Initial Values

The initial adjustable cell values can affect the path *What'sBest!* takes to the solution. Starting with initial adjustable cell values near the optimal solution can reduce the solution time.

In many situations, you may not know good initial values. However, when reasonable values are known, they should be used. If near-optimal values are not known, simply starting with values that satisfy all constraints may be helpful. Starting from any reasonable answer may be better than starting with zeroes in the adjustable cells.

Always start with adjustable cell values that avoid undefined values in adjustable-dependent equations. For example, if an equation divides by an adjustable cell, then a value of zero for that adjustable cell makes the equation take an undefined value. Start the solve attempt with a nonzero value for that adjustable cell.

Consider changing the initial values and re-solving the model if: 1) you suspect there is an answer better than the answer returned by *What'sBest!*; 2) you know a feasible solution exists even though *What'sBest!* returns the message "No Feasible Solution Found".

### Use Reasonable Bounding Constraints

Adding constraints that bound the upper and/or lower values of adjustable cells to fall within a reasonable range of values may help shorten the solution time.

For example, assume you know that reasonable values for an adjustable cell A1 are between 500 and 1000. Values outside of this range are not mathematically impossible—they just don't make sense. Add the constraints:  $WB(A1, ">=", 500)$  and  $WB(A1, "<=", 1000)$ . This ensures that *What'sBest!* won't waste computation time investigating solutions you would view as meaningless. Similarly, adding bounds to restrict expressions from investigating values at or very near undefined regions (i.e., division by zero) may reduce computation time and increase the reliability of the solution.

### Scale the Model to a Reasonable Range of Units

Try to model your problem so that the units involved are of similar orders of magnitude. Mathematically manipulating numbers that differ in size by a large amount can increase the computation time and may introduce problems due to round-off error.

---

For example, consider a financial problem with equations expressing an interest rate of 8.5% (.085) and budget constraints of \$12,850,000. The difference in magnitude between these numbers is on the order of 10 to the 9<sup>th</sup> (1/100th compared to 10,000,000). A difference of 10 to the 4<sup>th</sup> or less between the largest and smallest units would be preferable. In this case, the budget could be expressed in units of millions of dollars. That is, \$12.85 to represent \$12,850,000. This lowers the difference in magnitude of the units of these numbers to 10 to the 4<sup>th</sup> (1/100th compared to 10).

### Simplify Relationships

Whenever possible, use linear rather than nonlinear relationships. Some nonlinear expressions can be reformulated in a linear manner. A simple example is a constraint on the ratio of two adjustable cells. Consider the constraint:  $WB(A1/B1, "<=", .25)$  where A1 and B1 are adjustable cells that each must be greater than zero.

The relationship  $A1/B1$  is nonlinear. If you multiply both sides of the constraint by B1, the constraint becomes:  $WB(A1, "<=", .25*B1)$ . This is mathematically equivalent to the original constraint, but it is now a linear rather than nonlinear constraint.

As much as possible avoid non-smooth expressions, notably spreadsheet functions like *IF*, *MAX*, *MIN*, *ABS*, and table lookup functions. Models with non-smooth relationships are generally more difficult to solve. If you can, approximate the non-smooth relationship with a smooth expression.

### Reduce Integer Restrictions

Minimizing the use of integer restrictions can drastically reduce the solution time. In instances involving larger numbers, you may find that solving the model without integer restrictions and then rounding yields acceptable answers in a fraction of the time the integer model requires.

---

# Guidelines for Stochastic Modeling

So far, we worked with deterministic mathematical programs where model parameters (e.g. coefficients, bounds, etc.) are known constants. A stochastic program (SP) is a mathematical program (linear, nonlinear or mixed-integer) in which some of the model parameters are not known with certainty and the uncertainty can be described with known probability distributions. Applications arise in several industries:

- Multi-period financial portfolio planning with uncertain prices, interest rates, and exchange rates,
- Exploration planning for petroleum companies,
- Fuel purchasing when facing uncertain future fuel demand,
- Fleet assignment: vehicle type to route assignment in face of uncertain route demand,
- Electricity generator unit commitment in face of uncertain demand,
- Hydro management and flood control in face of uncertain rainfall,
- Optimal time to exercise for options in face of uncertain prices,
- Capacity and Production planning in face of uncertain future demands and prices,
- Foundry metal blending in face of uncertain input scrap qualities,
- Product planning in face of future technology uncertainty,
- Revenue management in the hospitality and transport industries.

## *Multistage Decision Making Under Uncertainty*

Stochastic programs fall into two major categories a) Multistage Stochastic Programs with Recourse, and b) Chance-Constrained Programs. What's *Best!* capabilities are extended to solve models in the first category, namely multistage stochastic recourse models. Chance-constrained models will be supported in future versions.

In this chapter, the term 'stochastic program' refers to a multistage stochastic model with recourse. The term 'stage', 'time' and 'period' are used interchangeably, unless otherwise is stated. The terms 'random parameter' and 'stochastic parameter' are also used interchangeably.

Multistage decision making under uncertainty involves making optimal decisions for a  $T$ -stage horizon before uncertain events (random parameters) are revealed while trying to protect against unfavorable outcomes that could be observed in the future.

In its most general form, a multistage decision process with  $T+1$  stages follows an alternating sequence of decisions and random events (*decisions-events-decisions-...-events-decisions*).

0.1) in stage 0, we make a decision  $x_0$ , taking into account that...

1.0) at the beginning of stage 1, “Nature” takes a set of random decisions  $\dot{u}_1$ , leading to realizations of all random events in stage 1, and...

1.1) at the end of stage 1, having seen nature’s decision, as well as our previous decisions, we make a recourse decision  $x_1(x_0, \dot{u}_1)$ , taking into account that ...

2.0) at the beginning of stage 2, “Nature” takes a set of random decisions  $\dot{u}_2$ , leading to realizations of all random events in stage 2, and...

2.1) at the end of stage 2, having seen nature’s decision, as well as our previous decisions, we make a recourse decision  $x_2(x_0, \dot{u}_1, x_1, \dot{u}_2)$ , taking into account that ...

⋮  
⋮

$T.0$ ) At the beginning of stage  $T$ , “Nature” takes a random decision,  $\dot{u}_T$ , leading to realizations of all random events in stage  $T$ , and...

$T.1$ ) at the end of stage  $T$ , having seen all of nature’s  $T$  previous decisions, as well as all our previous decisions, we make the final recourse decision  $x_T(x_0, \dot{u}_1, x_1, \dot{u}_2, \dots, \dot{u}_T)$ .

This relationship between the decision variables and realizations of random data can be illustrated as follows:

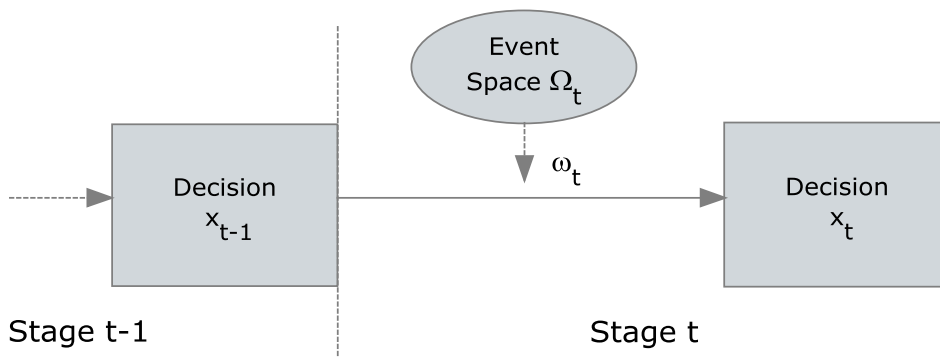

Each decision, represented with a rectangle, corresponds to an uninterrupted sequence of decisions until the next random event. And each random observation corresponds to an uninterrupted sequence of random events until the next decision point.

**Note:** A stage is the pair: random event, followed by a decision. The initial stage 0 is special in that it consists only of our first decision. The final stage may be special in that it may consist of just a random event with no explicit final decision.

### Recourse Models

The decision taken in stage-0 is called the initial decision, whereas decisions taken in succeeding stages are called 'recourse decisions'. Recourse decisions are interpreted as corrective actions that are based on the actual values the random parameters realized so far, as well as the past decisions taken thus far. Recourse decisions provide latitude for obtaining improved overall solutions by realigning the initial decision with possible realizations of uncertainties in the best possible way.

Restricting ourselves to linear multistage stochastic programs for illustration, we have the following form for a multistage stochastic program with  $(T+1)$  stages.

$$\text{Minimize (or maximize) } c_0x_0 + E_1[c_1x_1 + E_2[ c_2x_2 \dots + ET[ cTxT ] \dots]]$$

Such that

$$\begin{aligned} A_{00}x_0 & \sim b_0 \\ A(\hat{u}_1)_1x_0 + A(\hat{u}_1)_1x_1 & \sim b(\hat{u}_1)_1 \\ A(\hat{u}_1, \dots, \hat{u}_2)_2x_0 + A(\hat{u}_1, \dots, \hat{u}_2)_2x_1 + A(\hat{u}_1, \dots, \hat{u}_2)_2x_2 & \sim b(\hat{u}_1, \dots, \hat{u}_2)_2 \\ & \vdots \\ & \dots \\ & \vdots \\ A(\hat{u}_1, \dots, \hat{u}_T)_Tx_0 + A(\hat{u}_1, \dots, \hat{u}_T)_Tx_1 + \dots + A(\hat{u}_1, \dots, \hat{u}_T)_Tx_T & \sim b(\hat{u}_1, \dots, \hat{u}_T)_T \\ L_0 & \leq x_0 \leq U_0 \\ L(\hat{u}_1)_1 & \leq x_1 \leq U(\hat{u}_1)_1 \\ & \vdots \\ & \vdots \\ L(\hat{u}_1, \dots, \hat{u}_T)_T & \leq x_T \leq U(\hat{u}_1, \dots, \hat{u}_T)_T \end{aligned}$$

where,  $(\hat{u}_1, \hat{u}_2, \dots, \hat{u}_t)$  represents random outcomes from event space  $(\hat{U}_1, \dots, \hat{U}_t)$  up to stage  $t$ ,  $A(\hat{u}_1, \dots, \hat{u}_t)_t$  is the coefficient matrix generated by outcomes up to stage- $t$  for all  $p=1 \dots t, t=1 \dots T$ ,  $c(\hat{u}_1, \dots, \hat{u}_t)_t$  is the objective coefficients generated by outcomes up to stage- $t$  for all  $t=1 \dots T$ ,  $b(\hat{u}_1, \dots, \hat{u}_t)_t$  is the right-hand-side values generated by outcomes up to stage- $t$  for all  $t=1 \dots T$ ,  $L(\hat{u}_1, \dots, \hat{u}_t)_t$  and  $U(\hat{u}_1, \dots, \hat{u}_t)_t$  are the lower and upper bounds generated by outcomes up to stage- $t$  for all  $t=1 \dots T$ , '~' is one of the relational operators '<=>', '=', or '>='; and

$x_0$  and  $x_t = x(\hat{u}_1, \hat{u}_2, \dots, \hat{u}_t)_t$  are the decision variables (unknowns) for which optimal values are sought. The expression being optimized is called the cost due to initial-stage plus the expected cost of recourse.

**Note:** What'sBest! can solve linear, nonlinear and integer multistage stochastic programming problems.

---

## Scenario Tree

When the probability distributions for all random variables are discrete and finite, then there are only a finite number of outcomes in each stage. With each random parameter fixed to one of its possible outcomes, one can create a scenario representing one possible realization of the future. Enumeration of all possible combinations of outcomes allows us to represent all scenarios in a tree, with each scenario being a path from the root of the tree to one of its leaves. The nodes visited by each path correspond to values assumed by random parameters in the model.

### *Defining an SP Model in What'sBest! : Simple 2-Stage Example*

There is a relatively straightforward five step process for setting up an SP model in What'sBest!. All the information about the SP features is stored explicitly/openly on the spreadsheet. The five steps are:

Step 1) Define a core (or deterministic) model as a regular deterministic What'sBest! model. You can "plug" regular numbers in a random cell to check results.

Step 2) Specify staging information about the sequence of decisions and random events. This information is stored directly on the spreadsheet using special What'sBest! functions. These functions and formats are:

Decision variable and their stages are identified by: `WBSP_VAR(stage, cell_list)` and  
Random variables and their stage are identified by: `WBSP_RAND(stage, cell_list)`;

Step 3) Distribution information about random cells is stored in  
`WBSP_DIST_distribution(table, cell_list)`;  
where distribution specifies the distribution, e.g., NORMAL.

Step 4) Sample size for each stage is stored in  
`WBSP_STSC(table)`;

Step 5) Cells to be reported are listed in  
`WBSP_REP(cell_list)` or `WBSP_HIST(bins, cell_list)`;

You may type these functions in directly, or you may use the *Options...|Stochastic Solver* drop-down menu in What'sBest! to guide you through the steps.

We illustrate the formulation of an SP model in What'sBest! with perhaps the simplest SP model possible, the one product newsvendor problem (model `SP_NEWSVENDOR.XLSX`). This model has just two stages. In stage 0 (half stage) we must decide how much to stock,  $Q$ , of a single product. At the beginning of stage 1, demand,  $D$ , is revealed. At the end of stage 1 we sell the minimum( $D, Q$ ), enjoy our sales revenue and pay a penalty, if any, for unsatisfied demand or pay a holding cost for leftover inventory.

---

The SP\_NEWSVENDOR Worksheet before Optimization (part 1)

**Stochastic/Scenario Optimization of Newsvendor, Normal Demand**

Given all costs and prices, in  
 Stage 0, we must decide how many newspapers to stock.  
 Stage 1, in the beginning, unknown demand is revealed to us.  
 Stage 1, at the end, we compute our sales and the resulting profit.

**Step 1)** *Core model*

CP=Purchase cost/unit=	30	
H=Holding cost/(unit leftover)=	5	
P=Shortage cost/(unit unsatisfied demand)=	20	
V=revenue per unit sold=	65	
Q=Stock level(stage 0 decision)=	0	<<== Stage 0 decision.
D=Demand(stage 1 random variable)=	80	<<== Stage 1 random demand.
LS=Lost sales=	0	<<== Stage 1 (recourse) decision.
LS>=D-Q(constraint)	Not >=	<<== Stage 1 constraint.
I=Inventory=Q-D+LS=	-80	<<== Stage 1 decision and constraint.
I>=0(constraint)	Not >=	<<== Stage 1 non-negativity constraint.
TC=Total cost of goods=CP*Q=	0	<<== Stage 0 cost computation.
TH=Total Holding cost=H*I =	-400	<<== Stage 1 holding cost computation.
TS=Total Shortage cost=P*LS=	0	<<== Stage 1 shortage cost computation.
VI=Revenue=V*(D-LS)=	5200	<<== Stage 1 revenue computation.
Profit, Expected Value [To be maximized]=		
TP=VI-TC-TH-TS=	5600	<<== Stage 1 expected value (maximize).

Model Scenario Tree

READY 80%

## The SP\_NEWSVENDOR Worksheet before Optimization (part 2)

The screenshot shows an Excel spreadsheet with the following content:

	C	D	E	F	G	H	I	J	K	L	M
3	back.										
4	led to us.										
5	ulting profit.										
6	Core model										
7											
8											
9											
10											
11	<<== Stage 0 decision.										
12	<<== Stage 1 random demand.										
13	<<== Stage 1 (recourse) decision.										
14	<<== Stage 1 constraint.										
15	<<== Stage 1 decision and constraint.										
16	<<== Stage 1 non-negativity constraint.										
17	<<== Stage 0 cost computation.										
18	<<== Stage 1 holding cost computation.										
19	<<== Stage 1 shortage cost computation.										
20	<<== Stage 1 revenue computation.										
21											
22	<<== Stage 1 expected value (maximize).										
23											
24											
25											

The spreadsheet is titled 'Stochastic/Scenario Optimization' and shows the following steps:

- Step 2) Stage information:** WBSP\_VAR (Q, TC stage 0), WBSP\_RAND, WBSP\_VAR
- Step 3) Distribution information:** WBSP\_DIST\_NORMAL, 80 Mean Demand, 20 Standard Deviation
- Step 4) Sample size:** WBSP\_STSC, Stage Scenarios: 1, 200
- Step 5) Reporting cells:** WBSP\_REP, WBSP\_HIST

For this specific problem, the five steps mentioned earlier are:

**Step 1)** The core model is described numerically in column B and in words in columns A and C.

**Step 2)** We specify cell B11 as a stage 0 decision variable by inserting the expression:

=WSP\_VAR(0,B11)

into cell I6. We can enter this expression directly, or using the Stochastic Support dialog box.

We specify cell B12 as a stage 1 random variable by inserting the expression:

=WSP\_RAND(1,B12) into cell I8.

The cell B13 is the recourse decision adjustable at stage 1:

=WSP\_VAR(1,B13)

**Step 3)** We tell What'sBest! that demand has a Normal distribution with mean 80 and standard deviation 20 by inserting the expression:

=WSP\_DIST\_NORMAL(I15,I16,B12) into cell I13.



Step 4) We tell What'sBest! how many scenarios to use in each stage (i.e., the sample size) by inserting the expression:

=WBSP\_STSC(I21:J21) into cell I19.

Step 5) We specify that we want a scenario-by-scenario report on the amount ordered, the demand, lost sales, and profit by placing the expression:

=WBSP\_REP(B11,B12,B13,B22) in cell I24.

We request a nine bin histogram of Profit by placing the expression:

=WBSP\_HIST(9,B22) in cell I25.

There is also an *Options...|Stochastic Solver* dialog box for setting various SP related options:

---

Stochastic Support X

Use Stochastic Modeling Support

Core | Stage | Distribution | Scenario | Reports | Chance-Constrained

2) Specify the stage information for the Variables (Adjustables, Formulas, Constraints cells), and the Random cells using the set of WBSP\_

	Stage:	Refers to:
WBSP_VAR	0	\$A\$1

Place function in cell:

Specifications

Optimization Method:

Seed for Random Generator:

Common Size per Stage:

Sampling on Continuous Distribution Only

The SP\_NEWSVENDOR Worksheet After Optimization

**Stochastic/Scenario Optimization of Newsvendor, Normal Demand**

Given all costs and prices, in  
 Stage 0, we must decide how many newspapers to stock.  
 Stage 1, in the beginning, unknown demand is revealed to us.  
 Stage 1, at the end, we compute our sales and the resulting profit.

**Step 1)** *Core model*

CP=Purchase cost/unit=	30	
H=Holding cost/(unit leftover)=	5	
P=Shortage cost/(unit unsatisfied demand)=	20	
V=revenue per unit sold=	65	
Q=Stock level(stage 0 decision)=	85.795	<<== Stage 0 decision.
D=Demand(stage 1 random variable)=	11.446	<<== Stage 1 random demand.
LS=Lost sales=	0	<<== Stage 1 (recourse) decision.
LS>=D-Q(constraint)	>=	<<== Stage 1 constraint.
I=Inventory=Q-D+LS=	74.349	<<== Stage 1 decision and constraint.
I>=0(constraint)	>=	<<== Stage 1 non-negativity constraint.
TC=Total cost of goods=CP*Q=	2573.8	<<== Stage 0 cost computation.
TH=Total Holding cost=H*I=	371.75	<<== Stage 1 holding cost computation.
TS=Total Shortage cost=P*LS=	0	<<== Stage 1 shortage cost computation.
VI=Revenue=V*(D-LS)=	743.97	<<== Stage 1 revenue computation.
Profit, Expected Value [To be maximized]=		
TP=VI-TC-TH-TS=	-2201.62	<<== Stage 1 expected value (maximize).

Model Scer ...

The solver writes a series of solution in the created tab 'WB!\_Stochastic', and 'WB!\_Histogram', with the expected value, and displays the first default scenario, or a selected scenario, on the spreadsheet.

The scenario-by-scenario report is generated on the *WB!\_Stochastic* tab. A portion of it appears below.

The screenshot shows an Excel spreadsheet with the following content:

What'sBest!® 13.0.0.0 (Sep 30, 2014) - Lib. 9.0.1889.103 - 64-bit - Stochastic

DATE GENERATED: Oct 14, 2014 09:39 AM

STOCHASTIC INFORMATION:

CLASSIFICATION DATA	Current	Capacity Limits
Adjustables	1800	Unlimited
Integers/Binaries	0	Unlimited
Constraints	1599	Unlimited
Nonlinears	0	Unlimited
RANDOMS	1	
STAGES	2	
NODES	201	
SCENARIOS	200	

Expected Value (EV) 2.11E+03

Expected Value of Wait-and-See Model's Objective (EVWS) 2.80E+03

Any of the standard statistical tools in Excel can be used to analyze the scenario data.

The histogram generated on the *WB!\_Histogram* tab is:

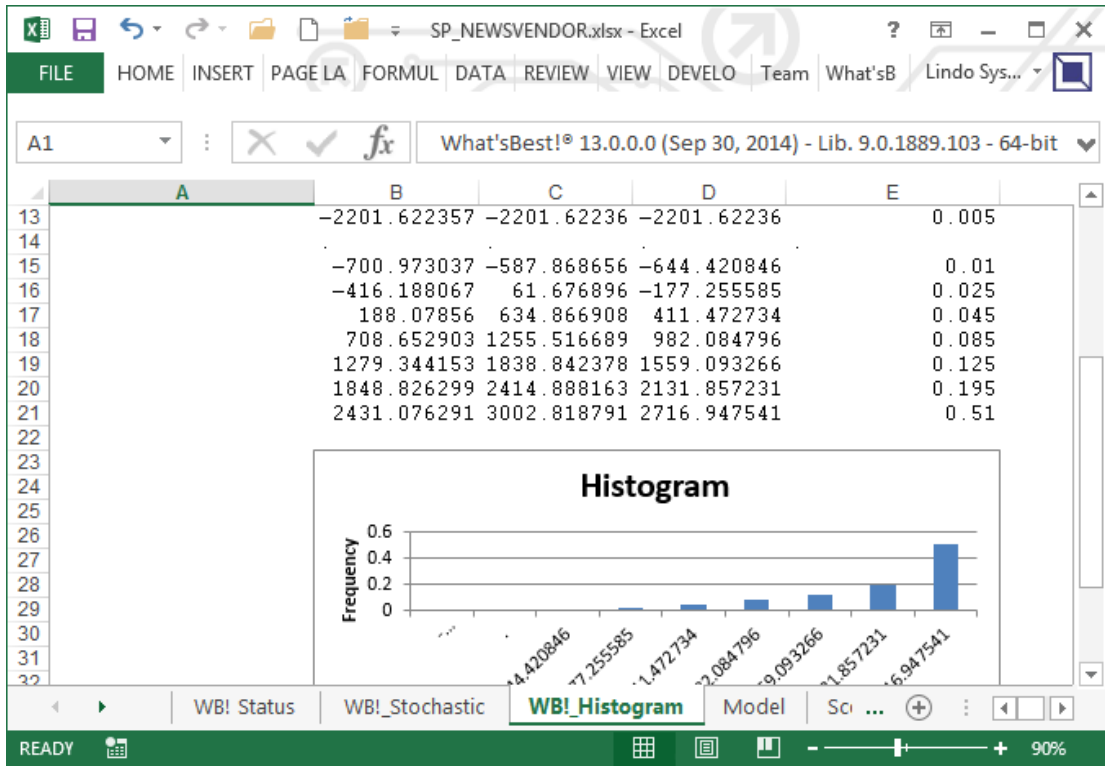

Notice that even though the driving random variable, Demand, has a Normal distribution, the total profit has a highly skewed, decidedly non-Normal, distribution.

The histogram graph is:

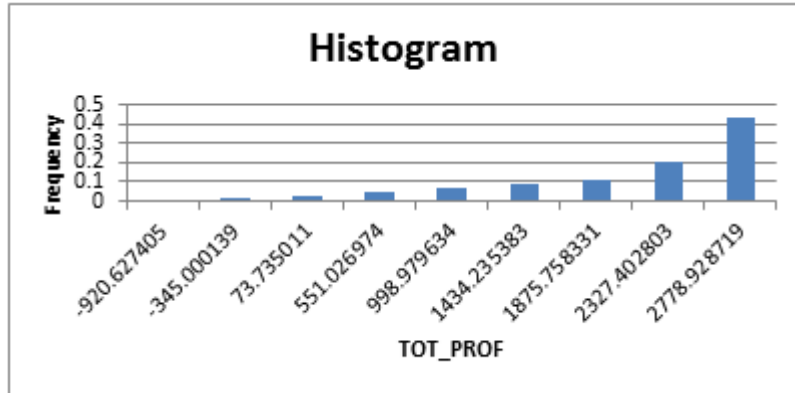

### *Defining an SP Model in What'sBest! : Multi-Stage Example*

Next we give a slightly more complex example that illustrates how to formulate an SP with more than two stages (model *SP\_INVESTMENTCOLLEGE.XLSX*). This example was originally given by Birge and Louveaux in their book, *Introduction to Stochastic Programming*. You want to set aside \$55,000 now, hoping that it will grow to \$80,000 in three periods so as to support your child in college. Only two investments are available, Stocks, and Bonds. At the beginning of each period or stage you (re)allocate you money between these two investments. Each year, the return on each investment is a random variable, given by the table:

	Stocks	Bonds
Scenario 1	1.25	1.14
Scenario 2	1.06	1.12

Stocks have the higher expected return, so if we just wished to maximize expected return, we would put all our money in Stocks at the beginning of each stage. Stocks, however, also have the greater variability, so if we are concerned about achieving our goal of \$80,000, then Bonds might seem more attractive with their lower variability in return.

The SP\_INVESTMENTCOLLEGE Worksheet Before Optimization (part 1)

The screenshot shows an Excel spreadsheet titled "SP\_INVESTMENTCOLLEGE.xlsx - Excel". The active cell is A1, containing the text "Investment Planning for Going to College After 3 Periods".

The spreadsheet content is as follows:

- Row 1:** Investment Planning for Going to College After 3 Periods.
- Row 2:** Two investment options each stage: Stocks and Bonds. Ref. Birge & Louveaux
- Row 3:** 80 = Goal for wealth at beginning of period 4
- Row 4:** 4 = Penalty/unit for wealth under goal
- Row 5:** 1 = Utility of wealth/unit over goal
- Row 6:** Step 1) Core model
- Row 7:** Step 2) Time stage specification
- Row 8:** Random variables
- Row 9:** Step 3) Distribution specification
- Row 10:** Step 4) Sampling specifications

Stage	Growth factor Stocks	Growth factor Bonds	Beginning Wealth	Total invested	Invest in Stocks	Invest in Bonds
0			55	Not = 0.0000	0.0000	0.0000
1	1.25	1.14	0	= 0.0000	0.0000	0.0000
2	1.25	1.14	0	= 0.0000	0.0000	0.0000
3	1.25	1.14	0			

Additional constraints and utility functions:

- Under goal: 0
- Over goal: -80 Not >= 0
- Net utility: -80 To be maximized

Red boxes highlight the following cells:

- WBSR\_RANDOM (three instances)
- WBSR\_DIST\_DISCRETE\_SV (three instances)
- WBSR\_STSC

The screenshot shows an Excel spreadsheet with the following content:

	G	H	I	J	K	L	M	N	O	P	Q
4	wealth under goal			<b>Step 2) Time stage specifications for...</b>							
5	unit over goal			Random variables			Decision variables				
6				WBSP_RAND			WBSP_VAR				
7	Invest in			WBSP_RAND			WBSP_VAR				
8	Stocks	Bonds		WBSP_RAND			WBSP_VAR				
9	0.0000	0.0000		WBSP_RAND			WBSP_VAR				
10	0.0000	0.0000									
11	0.0000	0.0000		<b>Step 3) Distribution specifications</b>							
12				WBSP_DIST_DISCRETE_SV			Growth factor distribution				
13				WBSP_DIST_DISCRETE_SV			(equally likely)				
14				WBSP_DIST_DISCRETE_SV			Scenario				
15							A	1.25	1.14		
16							B	1.06	1.12		
17				<b>Step 4) Sampling specifications by stage</b>							
18				WBSP_STSC							
19							Stage Scenarios				
20							1	2			
21							2	2			
22							3	2			
23				<b>Step 5) Reporting specifications</b>							
24				WBSP_REP							
25				WBSP_HIST							
26											

Stepping through the five steps again for this multistage example,

**Step 1)** The core model is described in the range A3:H16.

The growth factors for Stocks and Bonds are in columns B and C. They will be declared random in step 2 below. The beginning wealth before each allocation decision is given in column D. At the beginning it is a constant 55. In subsequent periods the wealth available comes previous period investments and is given by the formulae:

$$D10=\text{SUMPRODUCT}(G9:H9,B10:C10)$$

$$D11=\text{SUMPRODUCT}(G10:H10,B11:C11)$$

$$D12=\text{SUMPRODUCT}(G11:H11,B12:C12)$$

The decision variables of how much to invest in Stocks and Bonds each period is in columns G and H. The total amount invested is computed in column F and is given by:

$$F9=\text{SUM}(G9:H9)$$

$$F10=\text{SUM}(G10:H10)$$

$$F11=\text{SUM}(G11:H11)$$

We require the amount invested each period to equal the amount available.

This is enforced by the constraints in column E:

$$E9=\text{WB}(D9,"=",F9)$$

$$E10=\text{WB}(D10,"=",F10)$$



$$E11=WB(D11,"=",F11)$$

The amount over goal at the end is computed with:

$$D15=D12-D3+D14$$

The constraint in E15 constrains this to be nonnegative.

$$E15=WB(D15,">=",F15)$$

The amount under goal is in D15.

The net utility to be maximized is given by:

$$D16=D5*D15-D4*D14$$

Step 2) We specify cells G9, H9 as a stage 0 (half stage) decision variable by inserting the expression:

$$=WBSP\_VAR(0,G9,H9)$$

into cell L6. We specify cells B10, C10 as stage 1 random variables that are observed at the beginning of stage 1 by inserting in cell J7 the expression:

$$=WBSP\_RAND(1,B10,C10).$$

Similar expressions are in cells L7, L8, L9, J8, and J9 for the remaining stages 1 to 3.

The cell D14 is the recourse decision adjustable at stage 3:

$$=WBSP\_VAR(3,D14)$$

Step 3) We tell What'sBest! that the growth factors have a joint discrete distribution as listed in the scenario table S13:T14 by inserting the expressions:

$$=WBSP\_DIST\_DISCRETE\_SV(M15:N16,B10,C10)$$

$$=WBSP\_DIST\_DISCRETE\_SV(M15:N16,B11,C11)$$

$$=WBSP\_DIST\_DISCRETE\_SV(M15:N16,B12,C12)$$

into cells J12, J13, and J14.

Step 4) We tell What'sBest! how many scenarios to use in each stage (i.e., the sample size) by inserting the expression:

$$=WBSP\_STSC(L20:M22) \text{ into cell J19.}$$

Step 5) We specify that we want a scenario-by-scenario report of the wealth and the allocation to Stocks and Bonds each period, by placing the expression:

$$=WBSP\_REP(F9,G9,H9,Wealth1,G10,H10,Wealth2,G11,H11,D12,D14,D15,D16)$$

into cell J25. Similarly, the cell J26 contains the function for the histogram, over 10 bins, as

$$=WBSP\_HIST(10,D12).$$

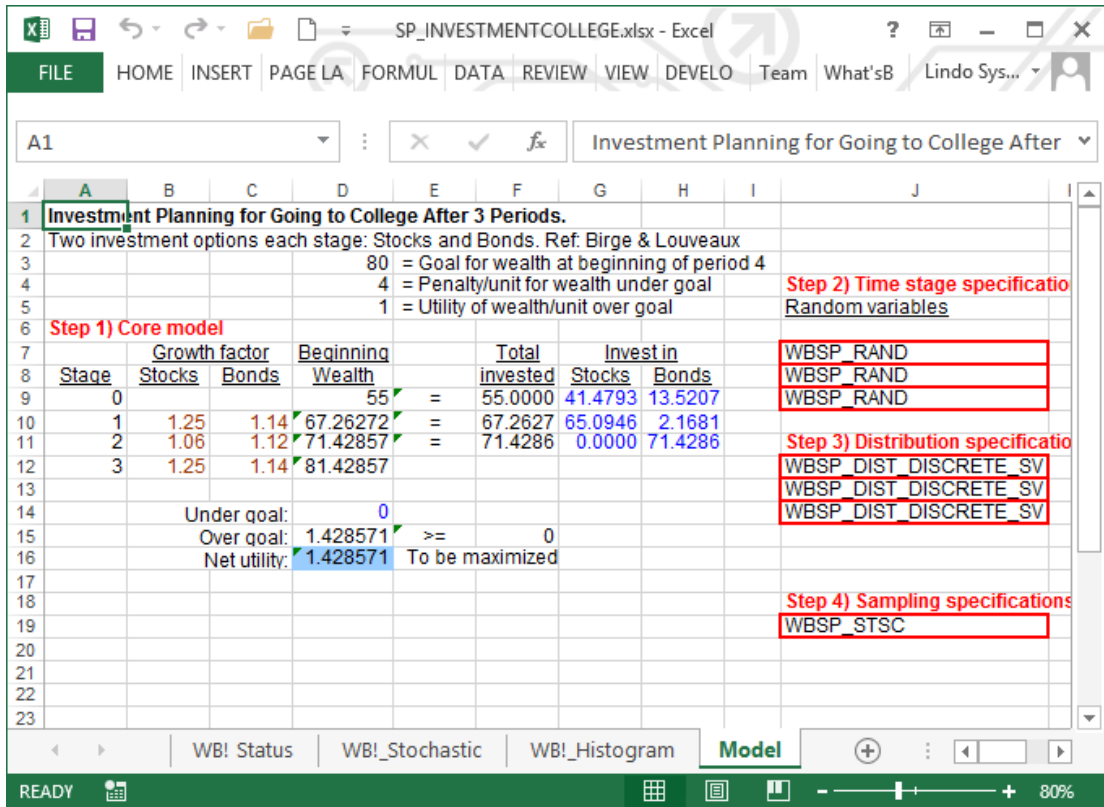

The solver writes a series of solution in the created tab 'WB! Stochastic', and 'WB! Histogram', with the expected value, and displays the first default scenario, or a selected scenario, on the spreadsheet.

The scenario-by-scenario report is generated on the *WB!\_Stochastic* tab:

	Model!D10	Model!G10	Model!H10	Model!D11	Model!G11	Model!H11	Model!D12	Model!H12
26	WEALTH1	STOCKINVEST1	BONDINVEST1	WEALTH2	STOCKINVEST2	BONDINVEST2	WEALTH3	UN
27	STAGE 1	STAGE 1	STAGE 1	STAGE 2	STAGE 2	STAGE 2	STAGE 3	
28								
29								
30	67.26272	65.094582	2.168138	71.428571	0	71.428571	81.428571	
31	67.26272	65.094582	2.168138	71.428571	0	71.428571	80	
32	67.26272	65.094582	2.168138	83.839905	83.839905	0	104.79988	
33	67.26272	65.094582	2.168138	83.839905	83.839905	0	88.870299	
34	59.11124	36.743215	22.368029	64	64	0	80	
35	59.11124	36.743215	22.368029	64	64	0	67.84	
36	59.11124	36.743215	22.368029	71.428571	0	71.428571	81.428571	
37	59.11124	36.743215	22.368029	71.428571	0	71.428571	80	

The scenario report we obtain is show above. Our expected utility at the end of the three periods is -1.514085. This means that there were some outcomes under which our final wealth fell short of our target wealth of \$80. This report gives complete detail on what to do each period. For example, at the beginning we should split our \$55 by investing \$41.479 into Stocks and \$13.521 in Bonds. Notice the interesting policy in period/stage 2. If our wealth is well below \$80, i.e., 64, or if our wealth is above \$80, then we invest all of our portfolio into Stocks. If our wealth is intermediate, i.e., 71.428571, then we invest all portfolio into bonds. The reasoning is that if we know we are going to fall short of our target or if we have already achieved our target, then we might as well invest in the instrument with highest expected returns, Stocks. On the other hand, if our beginning wealth stage 2 is \$71.428571, then if we put all our money into bonds, then we are guaranteed to (just) achieve our target of \$80.

## Monte Carlo Sampling

In stochastic programming where one or more stochastic parameters have continuous or discrete but infinite event space, there are an infinite number of possible scenarios, making the model computationally intractable. For such cases Monte Carlo sampling (also called pre-sampling) can be used to approximate the problem to work with a finite scenario tree. As illustrated in the figure below, if the model has a single stochastic parameter with a continuous distribution such as the Normal Distribution; one can discretize the event space simply by generating  $N$  sample points and construct a finite and tractable scenario tree. This is also true for discrete distributions with infinite event space like the Poisson distribution.

**Note:** Sampling a scenario tree prior to the optimization process is also called pre-sampling. This is to distinguish this type of sampling from the one that is used during optimization process. In *What'sBest!*, sampling refers to pre-sampling unless otherwise is stated.

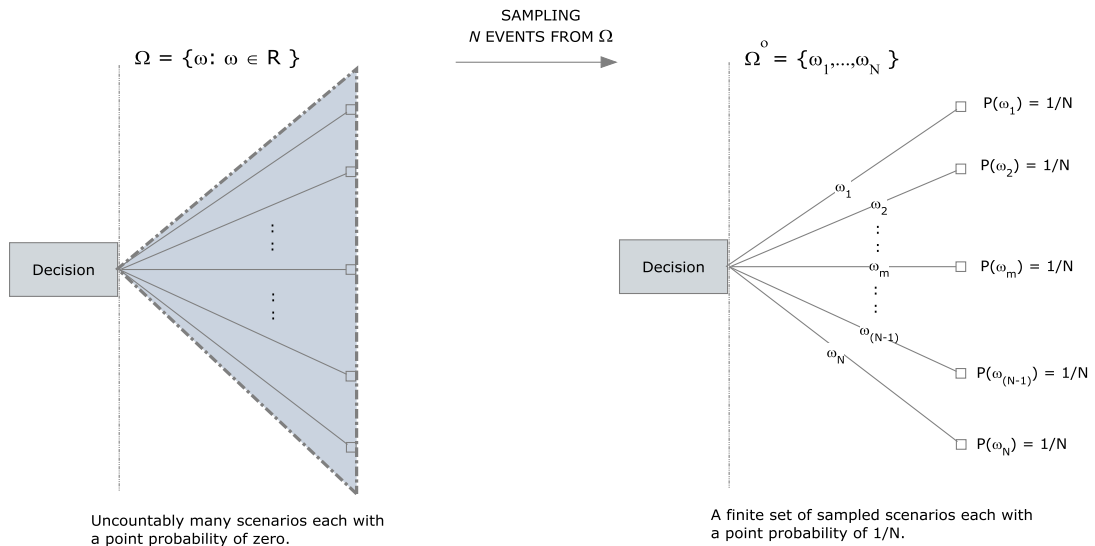

**Note:** Because the point probability of each scenario in the original model is zero, it is customary to set the probabilities of sampled scenarios to  $1/N$ . However, the user can always define customized sampling approaches to work with different scenario probabilities.

Given the parametric distribution of each stochastic parameter, *What'sBest!*'s sampling routines can be used to generate univariate samples from these distributions efficiently. The user has the option to use antithetic-variates or Latin-hypercube sampling to reduce the sample variance.

## Generating Dependent Samples

In certain situations, the modeler may require some of the random variables to be dependent on each other. There are several ways of doing this in *What'sBest!*. You can specify an explicit, arbitrary discrete joint distribution table form any of:

WBSP\_DIST\_DISCRETE\_SV(*table, rand\_vars*) (Equi-probable, sequenced vertically)  
 WBSP\_DIST\_DISCRETE\_SH(*table, rand\_vars*) (Equi-probable, sequenced horizontally)  
 WBSP\_DIST\_DISCRETE\_SV\_W(*table,prob,rand\_vars*) (Weighted prob., sequenced vertically)  
 WBSP\_DIST\_DISCRETE\_SH\_W(*table,prob,rand\_vars*) (Weighted prob., sequenced horizontally)

Another common way to characterize dependencies among variables drawn from standard univariate distributions such as the Normal or Poisson is by standard correlation measures. *What'sBest!* supports three correlation types:

WBSP\_CORR\_PEARSON(*matrix,rand\_vars*) (Pearson's linear correlation)  
 WBSP\_CORR\_SPEARMAN(*matrix,rand\_vars*) (Spearman's rank correlation)  
 WBSP\_CORR\_KENDALL(*matrix,rand\_vars*) (Kendall's rank correlation)

## Sampling a Scenario Tree

For stochastic programs with infinite event space, *What'sBest!* offers an easy to use function to create finite scenario trees implicitly with user-specified dimensions. This is especially handy when there are several stochastic parameters and the task of explicit sampling becomes tedious. In this context, the user can specify the dimensions of a scenario tree by either of the following methods:

**Specify the number of nodes per stage:** In this method, the user should provide an integer array of length  $T$  (number of stages in the model) and give in each position the number of nodes to be created in that stage. By default stage-0 will always one node, thus the 0th index in the array will be one. Other positions in the array, corresponding to the number of nodes in stages 1,2,...  $T-1$ , may take any positive integer values. In this framework, each node represents a block realization of all the stochastic parameters in that stage and will have a conditional probability of  $1/N_t$ , where  $N_t$  represents the number of nodes in stage  $t$ .

**Specify the sample size per stochastic parameter:** In the method, the user should provide an integer array of length  $S$  (the number stochastic parameters in the model), and give in each position the sample size for that stochastic parameter.

In either case, *What'sBest!* will automatically construct a finite scenario tree with specified dimensions.

In a case where both stochastic parameters are normally distributed each belonging to a different stage. Therefore, creating  $N$  nodes per stage has the same effect as creating  $N$  samples per stochastic parameter whenever there is a single stochastic parameter per stage.

**Note:** Sampling a scenario tree is not limited to stochastic parameters that follow parametric distributions. It is also possible to use sampling for models, which already have a finite scenario tree. This is especially useful when the original tree is finite but still too big to handle computationally. For instance, a 2-stage model may have 30 stochastic parameters with two outcomes each. This will correspond to a scenario tree with  $2^{30} = 1.0737\text{e}+009$  scenarios. Sampling is essential for models with scenario trees this big.

## Guidelines for Chance-Constrained Modeling

The second major class of models in stochastic programming is Chance-Constrained Programs (CCP). A CCP model is a) similar to general stochastic programs in that the model contains random quantities with known distributions, but b) simpler in that the model has just a single decision stage and a single random outcome stage.

The goal in CCP is to make an optimal decision prior to realization of random data, while controlling the chance that constraints are violated. Consider an LP with random matrix  $E$  and random right-handside  $w$ :

*Min*  $c x$

$E x_i = w_i \quad i = 1 \dots m$

If we required all  $m$  realizations of  $E x = w$  to be satisfied, then we would get a very conservative/expensive solution  $x$ , or no feasible solution at all. The distinctive feature of CCP is that we require that  $E x = w$  be satisfied with some prespecified probability,  $0 < p < 1$ , as opposed to it being satisfied for all possible realizations of  $(E, w)$ .

### ***Defining a CCP Model in What'sBest! : Simple Feed Mixer Example***

There is a relatively straightforward six-step process for setting up an SP/CCP model in *What'sBest!*. All the information about the SP features is stored explicitly/openly on the spreadsheet, then the CCP part. The six steps are:

Step 1) Define a core (or deterministic) model as a regular deterministic *What'sBest!* model. You can “plug” regular numbers in a random cell to check results.

Step 2) Specify staging information about the sequence of decisions and random events. This information is stored directly on the spreadsheet using special *What'sBest!* functions. These functions and formats are:

Decision variable and their stages are identified by: `WBSP_VAR(stage, cell_list)`, where stage is 0, and

Random variables and their stage are identified by: `WBSP_RAND(stage, cell_list)`, where stage is 1;

Step 3) Distribution information about random cells is stored in

---

WBSP\_DIST\_distribution(table, cell\_list);  
where distribution specifies the distribution, e.g., NORMAL.

Step 4) Sample size for the 1 stage is stored in  
WBSP\_STSC(table);

Step 5) Cells to be reported are listed in  
WBSP\_REP(cell\_list) or WBSP\_HIST(bins, cell\_list);

Step Chance-Constrained) Cells to be reported are listed in  
WBSP\_CC\_LT(percent, weight, constraint cells) for "Less Than", or WBSP\_CC\_GT(percent, weight,  
constraint cells) for "Greater Than". One function will define one set of Chance Constraint.

You may type these functions in directly, or you may use the Options...|Stochastic Solver drop-down menu in What'sBest! to guide you through the steps.

We illustrate the formulation of an SP/CCP model in What'sBest! with perhaps the simplest SP/CCP model possible, the Feeder Mix problem (model *SP\_FEEDERMIXCCP.XLSX*). This model has just 1 stage. In stage 0 (half stage) we must decide how much X1..X4. At the beginning of stage 1, Protein, is revealed. At the end of stage 1 we minimize the Objective.

This model is an excerpt of the blending model, *HOGCHANC.XLSX*, explained in the Chance-Constrained Blending example.

---

The SP\_FEEDERMIXCCP Worksheet before Optimization

The screenshot shows an Excel spreadsheet with the following content:

**Product/Feed Mix Problem with Chance Constraints**

Van de Panne and Popp presented a CCP formulation of feed mixer problem. Obj= 29.89

The variables are defined at stage 0, the randoms at stage 1

**1) Core model**

	X1	X2	X3	X4	Total	
OBJ:	24.55	26.75	39	40.5	0.0000	
FAT:	2.3	5.6	11.1	1.3	0	Not >= 5
PROTEIN:	12	11.9	41.8	52.1	0	Not >= 21
UNITY:	1	1	1	1	0	Not = 1

**2) Stage info**

WBSP\_VAR

**3) Probability info**

The protein coefficients are random Normal.

	12	11.9	41.8	52.1
Means:	12	11.9	41.8	52.1
Std Dev:	0.53	0.44	4.5	0.79

WBSP\_DIST\_NORMAL

**4) Sampling info**

WBSP\_STSC

1	32
---	----

**5) Reporting cells**

WBSP\_REP

WBSP\_HIST

**Chance-Constrained section**

WBSP\_CC\_GT 0.8 << Prob{Protein constraint satisfied}



For this specific problem, the five steps mentioned earlier are:

Step 1) The core model is described numerically in the area B7 toH11.

Step 2) We specify cell B7:E7 as a stage 0 decision variable by inserting the expression:

=WBSP\_VAR(0,B7:E7)

into cell J7. We can enter this expression directly, or using the Stochastic Support dialog box.

We specify cell B10:E10 as a stage 1 random variable by inserting the expression:

=WBSP\_RAND(1,B10:E10) into cell J10.

Step 3) We tell *What'sBest!* that the protein coefficient has a Normal distribution with different Means and Standard Deviation by inserting the 4 separated expressions:

=WBSP\_DIST\_NORMAL(B15,B16,B10) into cell B17,

=WBSP\_DIST\_NORMAL(C15,C16,C10) into cell C18,

=WBSP\_DIST\_NORMAL(D15,D16,D10) into cell D19,

=WBSP\_DIST\_NORMAL(E15,E16,E10) into cell E20.

Step 4) We tell *What'sBest!* how many scenarios to use in each stage (i.e., the sample size) by inserting the expression:

=WBSP\_STSC(J15:K15) into cell J14.

Step 5) We specify that we want a scenario-by-scenario report on the Protein amount against its constraint by placing the expression:

=WBSP\_REP(F7,F10,H10) into cell J19.

We request a histogram of Protein Amount by placing the expression:

=WBSP\_HIST(0,'Feeder Mix'!F10) into cell J20.

Chance-Constrained We specify that we want more than 80% probability to have the Protein amount constraint satisfied to consider the model feasible, by placing the expression:

=WBSP\_CC\_GT(C23,0,G10) into cell A23.

All the Expected Value calculation will be turned off in this type of model.

The SP\_FEEDERMIXCCP Worksheet After Optimization

The screenshot displays the following data in the spreadsheet:

**1) Core model**

	X1	X2	X3	X4	Total	
	0.66874	0	0.30931	0.02195	29.3696	
OBJ:	24.55	26.75	39	40.5		
FAT:	2.3	5.6	11.1	1.3	5	=>= 5
PROTEIN:	12.0484	10.8224	50.9056	51.9565	24.9432	>= 21
UNITY:	1	1	1	1	1	= 1

**2) Stage info**

WBSP\_VAR

**3) Probability info**

The protein coefficients are random Normal.

	12	11.9	41.8	52.1
Means:	12	11.9	41.8	52.1
Std Dev:	0.53	0.44	4.5	0.79

WBSP\_DIST\_NORMAL

WBSP\_DIST\_NORMAL

WBSP\_DIST\_NORMAL

WBSP\_DIST\_NORMAL

**4) Sampling info**

WBSP\_STSC

1 32

**5) Reporting cells**

WBSP\_REP

WBSP\_HIST

**Chance-Constrained section**

WBSP\_CC\_GT 0.8 << Prob{Protein constraint satisfied}

The scenario-by-scenario report is generated on the *WB!\_Stochastic* tab. A portion of it appears below.

SCENARIO	SET	TYPE	TARGET	WEIGHT	STATUS	REFERENCE
- 1-	Feeder Mix!G10	G		0.8	0 Satisfied	Feeder Mix!G10
- 2-	Feeder Mix!G10	G		0.8	0 Not satisfied	Feeder Mix!G10
- 3-	Feeder Mix!G10	G		0.8	0 Satisfied	Feeder Mix!G10
- 4-	Feeder Mix!G10	G		0.8	0 Satisfied	Feeder Mix!G10
- 5-	Feeder Mix!G10	G		0.8	0 Satisfied	Feeder Mix!G10
- 6-	Feeder Mix!G10	G		0.8	0 Satisfied	Feeder Mix!G10
- 7-	Feeder Mix!G10	G		0.8	0 Satisfied	Feeder Mix!G10
- 8-	Feeder Mix!G10	G		0.8	0 Not satisfied	Feeder Mix!G10
- 9-	Feeder Mix!G10	G		0.8	0 Satisfied	Feeder Mix!G10

Any of the standard statistical tools in Excel can be used to analyze the scenario data.

The histogram generated on the *WB!\_Histogram* tab is:

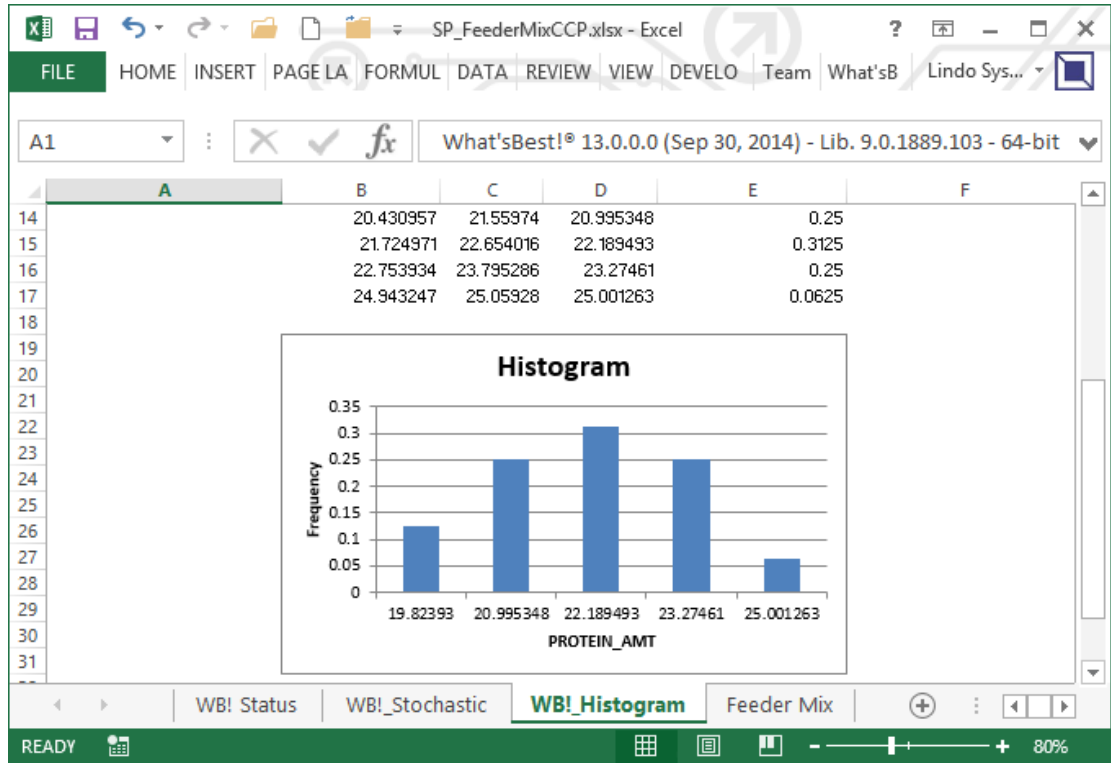

Notice that even though the driving random variable, Protein amount, has a Normal distribution.

The solver writes a series of solution in the created tab '*WB!\_Stochastic*', and '*WB!\_Histogram*', with the expected value, and displays the first default scenario, or a selected scenario, on the spreadsheet.

# Solving Second Order Cone Programs

The optimization capabilities of *What'sBest!* extend to the solution of second-order-cone problems (SOCP) of the following form

$$\text{Optimize } \|A_0 x + b_0\| + c^T x$$

subject to:

$$\|A_i x + b_i\| + c_i^T x - d_i \leq 0 \quad \text{for } i = 0, 1, \dots, m-1,$$

$$L_j \leq x_j \leq U_j \quad \text{for } j = 0, 1, \dots, n-1,$$

$$x_j \text{ is integer} \quad \text{for } j \text{ in a specified } J \subseteq \{0, \dots, n-1\}$$

where

*Optimize* is either minimize or maximize,

$A_i$  are matrices of appropriate dimensions  $i=0, \dots, m-1$ ,

$b_i$  and  $c_i$  are vectors of constants,

$d_i$  are constants,

$x = \{x_0, x_1, \dots, x_{n-1}\}$ , is an  $n$ -vector of decision variables.

"?" is one of the relational operators " $\leq$ ", "=", or " $\geq$ ".

Without the integrality restrictions, SOCPs are nonlinear convex problems that include linear and convex quadratically constrained quadratic programs as special cases. Several decision problems in engineering design and control can be formulated as SOCP. *What'sBest!* solves this class of problems using the so-called *conic optimizer*, which uses an interior-point algorithm. To solve a convex problem using *What'sBest!*, it may be advantageous to cast the problem (e.g. a QCQP) as a SOCP and use the conic optimizer.

To motivate the second-order cone problems and common forms of quadratic cones, consider the following two constraints:

$$x^2 + y^2 - z^2 \leq 0,$$

$$z \geq 0$$

Geometrically, the feasible region defined by these two constraints is an *ice cream cone*, with the point of the cone at (0,0,0). The feasible region for the constraint  $x^2 + y^2 - z^2 \leq 0$  by itself is not convex. The feasible region consists of two ice cream cones, one right side up, the other upside down, and with their pointy ends touching. The constraint  $z \geq 0$  eliminates the upside down cone and leaves the *quadratic cone* illustrated in Figure 1. Second-order cone problems are essentially a generalization of linear models defined over polyhedral cones to ones defined over quadratic cones.

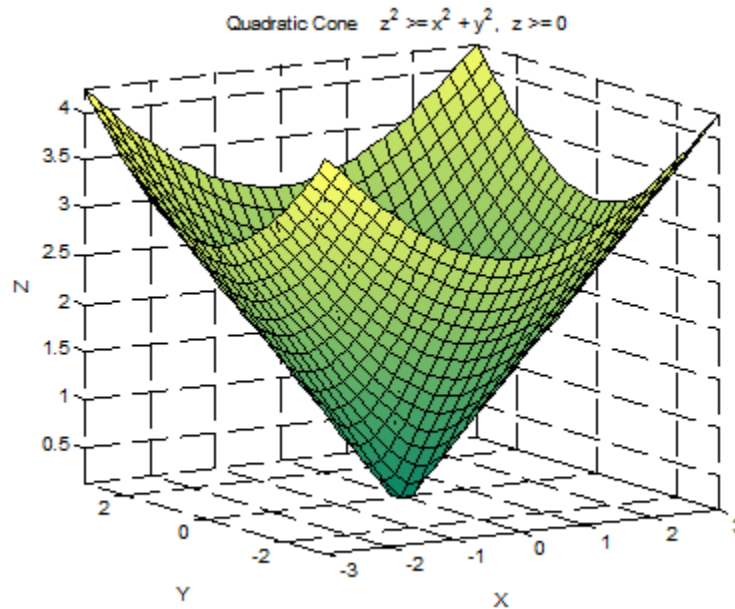

More generally, in  $n$  dimensions, a simple quadratic cone (ice-cream cone) constraint is of the form:

$$-x_0^2 + x_1^2 + x_2^2 + \dots + x_n^2 \leq 0;$$

$$x_0 \geq 0;$$

Second-order cone constraints are more general than they might at first appear. For another conic form, consider the constraints:

$$-uv + x^2 \leq 0,$$

$$u, v \geq 0.$$

The first constraint by itself describes a nonconvex feasible region (colored blue and green) illustrated in Figure 2. The three constraints together, however, describe a convex feasible region (colored green only) called the *rotated quadratic cone*.

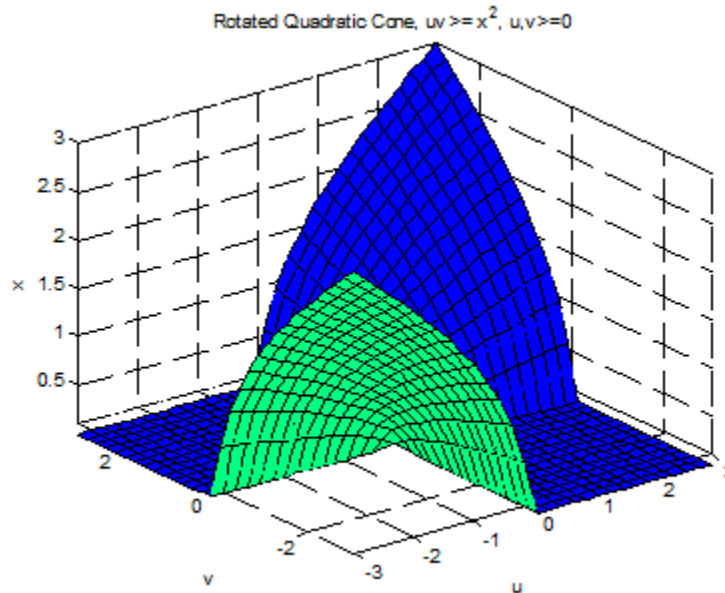

Figure 2. Rotated Quadratic Cone

More generally, in  $n$  dimensions, the rotated quadratic cone constraint in standard form is:

$$-2x_0 x_1 + x_2^2 + x_3^2 + \dots + x_n^2 \leq 0;$$

$$x_0, x_1 \geq 0;$$

In both simple and rotated quadratic cones, a variable can appear in at most one cone constraint. If naturally you would like to have a variable, say  $x_2$ , appear in two cone constraints, then you must introduce an extra copy of the variable, say  $y_2$ , for the second cone constraint and then connect the two with the linear constraint  $x_2 - y_2 = 0$ .

Notice, using a standard transformation, rotated quadratic cone constraints can be shown to be equivalent to quadratic cone constraints:

$$y = (u - v)/2,$$

$$z = (u + v)/2,$$

$$x^2 + y^2 - z^2 \leq 0,$$

$$z \geq 0.$$





---

# 7 Sample Models

---

## *Introduction*

This section provides sample models for problems in manufacturing, finance, engineering, scheduling, etc. They are real-world problems that demonstrate the practical use of the elegant concepts of linear and nonlinear programming.

A major strength and advantage of the spreadsheet environment compared to the more traditional methods of mathematical modeling is the ease with which relationships among data are visualized.

We've assembled a wide range of sample spreadsheet models for you to investigate. Some of them are very nearly full-fledged applications. All of them clearly demonstrate the principles of modeling with *What'sBest!*. We've organized them in the following groups.

### ***Blending Models***

Blending - Blending elements with various qualities into the lowest-cost product to meet designated quality requirements (HOGFEED.XLSX).

Chance-constrained Blending - As above, but quality content in the constituent elements varies at random, making the model nonlinear (HOGCHANC.XLSX).

### ***Engineering Models***

Box Design - A simple nonlinear model that finds dimensions for a cabinet to meet various design requirements (BOX.XLSX).

Flow Network Modeling - Calculating flow and pressure across a complex network (FLOWNET.XLSX).

### ***Financial Models***

Bond Portfolio Optimization - A multi-period model that recommends bond purchases to minimize costs while providing a specified cash flow (BONDS.XLSX).

Lockbox Location - Locating postal lockboxes to minimize "float" while still serving all customers (LOCKBOX.XLSX).

Markowitz Portfolio Problem - Selecting assets to meet a desired return at minimum variance (MARKOWIT.XLSX).

Portfolio with Transaction Costs - Adjusting a portfolio of assets in such a way that desired return after broker's fees and other transaction costs is met with minimum variance (PORTCOST.XLSX).

Minimizing Downside Risk - Purchasing and maintaining a portfolio of assets, so as to minimize the risk of losing value (DNRISK.XLSX).

Portfolio Scenario Model - Demonstrating the differences among minimizing three different measures of risk (PORTSCEN.XLSX).

### ***Forecasting Models***

Seasonal Sales Factoring - Determining the effect of seasonal factors on historical sales to improve forecasting (SEASON.XLSX).

Exponential Smoothing - Two models illustrating one technique for using historical data to predict future sales (SIMXPO.XLSX, SMOOTH.XLSX).

### ***Linearization Option and Construction Cost Estimation Models***

Linearization Option and Construction Cost Estimation – This model demonstrates the performance gains resulting from using the *What'sBest!* linearization option, and illustrates a case of estimating construction costs (LINEARZ.XLSX).

### ***Marketing Models***

Stratified Sampling - Determining the least-costly polling sample likely to give reliable results (SAMPLEWB.XLSX).

Car Pricing - A nonlinear pricing model - illustrating a case in which sales of products are interdependent (PRICING.XLSX).

Media Buying - Purchasing advertising media space to meet an exposure target at minimum cost (MEDIA.XLSX).

### ***Production Models***

Multi-Period Inventory Management - Managing inventory across multiple periods to minimize holding costs while maintaining sufficient stock (INVENT.XLSX).

Product Mix - Using available resources to manufacture a mix of products that yield the highest profit (PRODMIX.XLSX, PMIXMAC.XLSM).

The Building Block Method - Combining production and shipping models into one large model, a common approach to problem solving (BLOCK.XLSX).

Waste Minimization in Stock Cutting - Cutting sheet or coil materials to varying lengths while minimizing waste (CUTSTOCK.XLSX).

Plant Locating - Demonstrating how to locate plants or warehouse facilities to minimize shipping expenses while meeting demand (PLANTLOC.XLSX).

---

---

***Staff Scheduling Models***

Staff Scheduling - Meeting personnel needs at minimum cost (STAFF.XLSX).

Staff Sched.: Preferred Assignment - Covering staff needs while meeting employee preferences for job or shift assignments (ASSIGN.XLSX).

Staff Sched.: Two Stage Fixed Shift - Meeting two objectives, in this case minimizing cost and maximizing employee satisfaction, in scheduling (FIXED1.XLSX, FIXED2.XLSX).

***Transportation Models***

Pipeline Optimization - Moving resources along routes with limited capacities at minimum expense (PIPELINE.XLSX).

Shipping Cost Reduction - Minimizing shipping costs on routes with fixed costs while meeting demand (SHIPPING.XLSX).

Traffic Congestion Cost Minimization - Minimizing shipping costs on a network whose routes have costs that vary with the amount of traffic (TRAFFIC.XLSX).

Truck Loading - Packing a container with objects of varying sizes to maximize efficiency, a "knapsack" problem (TRUCK.XLSX).

***Stochastic Models***

Newsvendor Stock - A stochastic model to maximize net profit by deciding how much stock to hold, over 2 stages and 1 random parameter for the demand (SP\_NEWSVENDOR.XLSX).

Investment Planning College - A multi-period stochastic model planning investments for going to college, after 3 Periods. (SP\_INVESTMENTCOLLEGE.XLSX).

Crop Allocation Under Uncertainty - A stochastic model to maximize revenue by allocating crops to grow on a specified land area, over 2 stages and 1 random parameter for the weather condition (SP\_CROPALLOC.XLSX).

Put Option - A stochastic model to maximize wealth by selling an option at the right time, over a multi-stage structure and random parameters for the stock returns (SP\_PUTOPTION.XLSX).

---

# Blending

File name: HOGFEED.XLSX

TYPE: LINEAR OPTIMIZATION

---

## *Application Profile*

The manufacture of animal feed is an example of a blending problem. The question is: how do you mix a number of raw components into a minimum cost final blend that has specified amounts of certain ingredients?

In the case of hogfeed, the issue is vital. How can raw feedstocks be combined to produce a high nutrition hogfeed at lowest cost? For someone with several thousand hungry hogs, the quality of this answer can easily spell the difference between profit and loss. Since feedstock prices are typically volatile, the complexity of the question and the daily importance of reliable solutions is even more apparent.

Blending problems are also of interest well beyond the field of animal husbandry. Examples include finding the least costly mix of ores that will produce an alloy with specified characteristics or deciding on the most efficient combination of advertising media purchases to reach target audience percentages in multiple demographic groups.

## The Problem in Words

You are the manager of the Swine & Roses (S&R) Hogfarm and your hogfeed must meet certain minimum requirements for four nutrients,  $A$ ,  $B$ ,  $C$ , and  $D$ , to assure fast growth and large, robust animals.

---

## Background

The nutrients are found in four different grains. Each grain contains a different combination with a price that fluctuates with market conditions. The nutrient content by grain is shown in the following graph.

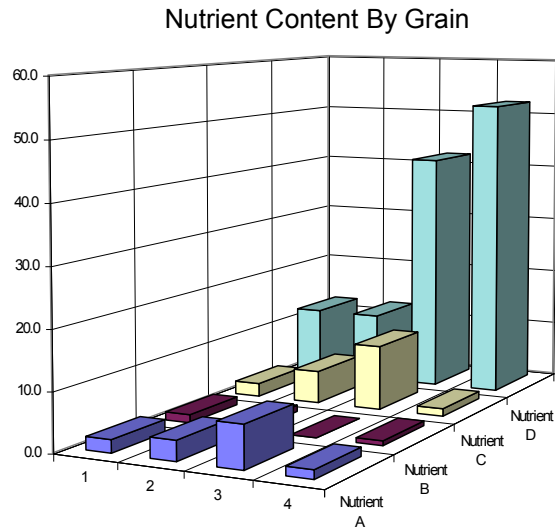

## Objective of Optimization

The objective is to determine how much of each grain S&R should buy at today's prices to meet their nutritional requirements at lowest cost. This always has a chance of being wrong if price fluctuates unexpectedly.

## The Worksheet

Let's open the *HOGFEED* sample file and look over the ABC's.

The *HOGFEED* Worksheet *Before* Optimization

The screenshot shows the Microsoft Excel interface with the HOGFEED.xlsx file open. The worksheet contains the following data:

Item	1	2	3	4	Nutrients Supplied	Minimum Req'd	Dual Value
Nutrient A	2.2	3.4	7.2	1.5	0.0	Not >= 2.4	\$1.00
Nutrient B	1.4	1.1	0.0	0.8	0.0	Not >= 0.7	\$1.00
Nutrient C	2.3	5.6	11.1	1.3	0.0	Not >= 5.0	\$1.00
Nutrient D	12.0	11.9	41.8	52.1	0.0	Not >= 21.0	\$1.00
Cost/Bushel	\$35.00	\$50.00	\$80.00	\$95.00			
Percentage of Blend	0.0%	0.0%	0.0%	0.0%	Unity? Not =	Total Cost	\$0.00
Dual Value	\$1.00	\$1.00	\$1.00	\$1.00			

**A. Determine Adjustable Cells**

The cells What'sBest! is free to change in this model are the *Percentage of Blend* contributed by each grain (C16:F16).

**B. Define Best**

The best solution to this problem meets nutritional needs at the lowest cost. *Total Cost*, J16, contains the formula *SUMPRODUCT*(C16:F16,C13:F13). That's the *Percentage of Blend* times the *Cost Per Bushel* for each grain.

**C. Specify Constraints**

There are two limitations on the solution to this problem. First, the final mix must contain the minimum required levels of nutrients. This is enforced by a constraint for each nutrient (H7:H10). Each constraint will return the "Not >=" indicator until the minimum requirement (I7:I10) for that nutrient is met in the *Nutrients Supplied* column (G7:G10). Second, the constraint in G16 forces the percentages in C16:F16 to sum to 100%.

The *Nutrients Supplied* cell for *Nutrient A* (G7) contains  $SUMPRODUCT(C7:F7, \$C\$16:\$F\$16)$ , which sums the product of the *Percentage of Blend* and the amount of *Nutrient A* for each grain. Each grain contains different combinations of each nutrient (C7:F10).

Now, let's solve the model with *What'sBest!* to find the optimal solution.

The *HOGFEED* Worksheet After Optimization

Item	Nutrient 1	Nutrient 2	Nutrient 3	Nutrient 4	Nutrient Supplied	Minimum Req'd	Dual Value
Nutrient A	2.2	3.4	7.2	1.5	3.7	>= 2.4	\$0.00
Nutrient B	1.4	1.1	0.0	0.8	1.0	>= 0.7	\$0.00
Nutrient C	2.3	5.6	11.1	1.3	5.0	=>= 5.0	(\$4.55)
Nutrient D	12.0	11.9	41.8	52.1	21.0	=>= 21.0	(\$0.17)
Cost/Bushel	\$35.00	\$50.00	\$80.00	\$95.00			
Percentage of Blend	68.5%	1.3%	30.2%	0.0%	Unity? =		Total Cost \$48.78
Dual Value	\$0.00	\$0.00	\$0.00	\$57.88			

The *What'sBest!* solution has a total cost of \$48.78 per bushel of the optimal blend. Grain 4, which is not a bargain at \$95 per bushel, is not purchased.

### D. Dual Values

Dual values have been included in two locations in this worksheet (C18:F18 and J7:J10).

The dual value entries in cells J7 through J10 show the reward (i.e., how much money could be saved) if each respective constraint (H7:H10) were relaxed by one unit. In practical terms, this means that you could save \$4.55 per bushel if the requirement for *Nutrient C* were reduced to 4. If slightly less sprightly hogs are tolerable in return for such a savings, relaxing this nutritional requirement would be a good decision. Likewise, if the requirement for *Nutrient D* were reduced to 20, the cost/bushel would go down by \$.17. Note that the dual values are zero for *Nutrients A* and *B*. Lowering the requirement by one unit offers no savings because there is already an excess of *Nutrients A* and *B* in your optimum blend, since constraints H7 and H8 are not tightly satisfied.

The other dual values in the *Swine & Roses* model (C18:F18) show the amount by which the price of an unused grain would have to be reduced before it would be cost effective to use it in the minimum cost blend. For example, the dual value for *Grain 4* is \$57.88 (F18). This tells you how much the price of *Grain 4* would have to be reduced in order for it to appear in the optimal solution of *HOGFEED*. This is a good number to have handy when negotiating to get a lower price. For more information on dual values, see the section on *Dual Values* in Chapter 3, *Additional Commands*.

---



---

# Chance-Constrained Blending

File name: HOGCHANC.XLSX

TYPE: NONLINEAR OPTIMIZATION

---

## Application Profile

In the previous *HOGFEED* blending example, we showed you a deterministic model — the nutrient content of the different grains to be incorporated in the finished feed were known and constant. However, what if the nutrient content is not so reliable? What if the content varies at random? This model is nonlinear and perhaps more likely to occur in the real world.

## The Problem In Words

You must determine how much of four available grains to include in blended feed (in circumstances under which the content of one of the nutrients varies at random) to meet nutrient requirements with some degree of certainty.

## Background

You've had several samples of the four grains tested and you find that their content of *Nutrient D* varies randomly and is normally distributed. You want to find a new blend that ensures the minimum requirements for *Nutrient D* are met at least 95% of the time.

You've calculated the mean and variance for each grain (the content means are the same as in the original *HOGFEED* model). The equation that calculates *Nutrient D* now looks like this:

$$(\text{Mean Nutrient D in the blend}) - Z * (\text{standard deviation Nutrient D}) \geq 21.$$

For 95% confidence in the content of *Nutrient D*, set  $Z = 1.645$  (Refer to any elementary text on statistics for a discussion of  $Z$  values).

## Objective of Optimization

The objective is to determine how much of each grain you should buy at today's prices to meet their nutritional requirements at lowest cost.

---

## The Worksheet

Let's look at the *HOGCHANC* worksheet as supplied in your sample files.

The *HOGCHANC* Worksheet *Before* Optimization

The screenshot shows the following data in the worksheet:

Item	1	2	3	4	Nutrients Supplied	Minimum Req'd	Dual Value
Nutrient A	2.2	3.4	7.2	1.5	0.0	2.4	\$1.00
Nutrient B	1.4	1.1	0.0	0.8	0.0	0.7	\$1.00
Nutrient C	2.3	5.6	11.1	1.3	0.0	5.0	\$1.00
Nutrient D: Mean Value	12.0	11.9	41.8	52.1	0.0	21.0	\$1.00
Variance	0.3	2.2	20.5	33.2			

Cost/Weight	\$35.00	\$50.00	\$80.00	\$95.00
Weight Units to Purchase	0.0%	0.0%	0.0%	0.0%
Dual Value	\$1.00	\$1.00	\$1.00	\$1.00

The Total Cost cell (J18) is \$0.00.

**A. Determine Adjustable Cells**

The cells *What'sBest!* is free to manipulate in this model are the *Weight Unit Percentages to Purchase* for each grain (C18:F18).

**B. Define Best**

The optimal solution to this problem is the one that meets needs at lowest cost. If you examine the formula in the *Total Cost* cell (J18), *SUMPRODUCT*(C18:F18,C15:F15), you see that every change in price or purchase quantities has a direct bearing on cost. *What'sBest!*, of course, is only free to change the purchase quantities in C18:F18.

**C. Specify Constraints**

The limitation to this problem is that the final mix must contain the minimum required levels of nutrients for Swine & Rose's hogs. This limitation is enforced by creating a constraint cell for each nutrient (H7:H9, H11). Each constraint will return the "Not >=" indicator until the *Minimum Required* (I7:I9, I11) for that nutrient is met in the *Nutrients Supplied* column (G7:G9, G11).

Now, let's solve the problem with *What'sBest!*.

The *HOGCHANC* Worksheet After Solving

Item	Nutrients Per Unit Weight of Grain	Nutrients Supplied	Minimum Req'd	Dual Value
Nutrient A	2.2	3.7	2.4	\$0.00
Nutrient B	1.4	0.9	0.7	\$0.00
Nutrient C	2.3	5.0	5.0	(\$0.97)
Nutrient D:				
Mean Value	12.0	21.0	21.0	(\$1.59)
Variance	0.3	33.2		

Cost/Weight	Grain 1	Grain 2	Grain 3	Grain 4
	\$35.00	\$50.00	\$80.00	\$95.00

Weight Units to Purchase	Grain 1	Grain 2	Grain 3	Grain 4	Unity?
	63.4%	0.0%	31.3%	5.3%	=

Dual Value	Grain 1	Grain 2	Grain 3	Grain 4
	\$0.00	\$11.62	\$0.00	\$0.00

Total Cost: \$52.26

This *What'sBest!* solution costs \$52.26 per bushel. It's more expensive than the *HOGFEED* solution in the previous example because you have compensated here for the variability in the amount of *Nutrient D* in the various component grains. It's now necessary to use the relatively more expensive *Grain 4*, rich in *Nutrient D*, to reach a 95% confidence in fulfilling all your nutritional requirements.

### D. Dual Values

Dual values are included in two locations in this worksheet (C20:F20 and J7:J9,J11).

The dual values in cells J7:J9,J11 show the shadow prices or reward (how much money you would save) if each respective requirement (I7:I9, I11) is relaxed by one unit. This means, for example, that you would save \$.97 per bushel if the requirement for *Nutrient C* is reduced to 4. A reduction to 4.9 saves you \$0.97. If slightly less sprightly hogs are tolerable in return for such a saving, relaxing this nutritional requirement would be a good decision. Note that the dual values are zero for *Nutrients A* and *B*. Lowering the requirement by one unit offers no savings because there is already an excess of *Nutrients A* and *B* in your optimum blend since constraints H7 and H8 are not tightly satisfied.

The other dual values in the *Swine & Roses* model (C20:F20) show the amount by which the price of an unused grain would have to be reduced before it would be cost effective to use it in the minimum cost blend. For example, the dual value for *Grain 2* is \$11.62 (D20). This tells you how much the price

---

of *Grain 2* would have to be reduced in order for it to appear in the optimal solution of *HOGCHANC*. This is a good number to have handy when negotiating to get a lower price.

---

**Note:** In nonlinear models, the ranges over which dual values are valid may be very small. Before basing a pricing or purchasing decision on a dual price or reduced cost in a nonlinear model, you should test the returned value by making the specified change to the variable or constraint, using *Adjustable*|*Remove Adjustable* on the variable, and re-solving.

---

# Box Design

*File name: BOX.XLSX*

*TYPE: NONLINEAR OPTIMIZATION*

---

## The Problem in Words

As a manufacturer of electronic equipment, you must design a cabinet for your new product that meets the specifications of various departments within your organization at minimum cost.

## Background

Your engineering department has determined that the equipment requires a volume of at least 1512 cubic inches and that a minimum surface area of 888 square inches will suffice to dissipate heat.

Marketing will find it easiest to sell the finished device if the footprint of the cabinet is no more than 252 square inches.

Finally, your designers have decreed that, for aesthetic reasons, the ratio of height to width should be  $.618 \pm .1$ . That is, between .518 and .718, inclusively.

The sheet metal from which the cabinet will be made costs \$.05 per square inch. Extra labor required on the front and back panels raises the cost for these components to \$.10 per square inch.

## Objective of Optimization

The objective is to determine the specifications of the box with the smallest production cost.

---

## The Worksheet

Let's open the *BOX* sample file. Let's look at how the requirements are translated to the spreadsheet format.

### The *BOX* Worksheet *Before* Optimization

The screenshot shows the Microsoft Excel interface with the 'BOX' worksheet open. The worksheet contains the following data:

	ACTUAL		LIMIT			
Surface Area	6.000	Not >=	888	Length	Width	Height
Footprint	1.000	<=	252	1.00	1.00	1.00
Volume	1.000	Not >=	1512			
Width / Height	1.000	Not <=	0.718	UNIT COST:		
Width / Height	1.000	>=	0.518	\$0.40		

#### A. Determine Adjustable Cells

The adjustable cells in the *BOX* model are the *Length*, *Width*, and *Height* in H8:J8. These cells are further identified as ranges *L*, *W*, and *H*, respectively.

#### B. Define Best

The best solution is the minimum cost cabinet that satisfies all the constraints. This objective is calculated in cell I13 by means of the following formula:

$$2*(0.05*(Length*Width+Length*Height)+0.1*(Height*Width))$$

The interpretation of which is: The cost of the side/top/bottom panels \* the sum of the areas of one side and one top/bottom panel + the cost of front/back panels \* the area of a front/back panel all multiplied by 2.

### C. Specify Constraints

The constraints are enforced by means of the formulas in D7, D9, D11, D13, and D15.

In D7, the formula  $WB(C7, ">=", E7)$  forces the total *Surface Area* of the cabinet in C7, calculated by the formula  $2*(Length*Width+Length*Height+Width*Height)$ , to be at least as great as the lower limit of 888 square inches in E7.

In D9, the formula  $WB(C9, "<=", E9)$  forces the *Footprint* in C9 to be no greater than the upper limit of 252 square inches in E9. The *Footprint* is calculated by the formula  $Width*Length$ .

In D11, the formula  $WB(C11, ">=", E11)$  forces the *Volume* in C11, calculated by the formula  $Length * Width * Height$ , to be at least as great as the lower limit of 1512 cubic inches required to fit the electronic equipment in the cabinet.

Finally, in D13 and D15, the formulas  $WB(C13, "<=", E13)$  and  $WB(C15, ">=", E15)$  force the ratio of *Height* to *Width* to fall between .718 and .518, where C13 and C15 both calculate  $Width/Height$ .

Now, you're ready to solve the model and find the optimum design.

#### The BOX Worksheet After Optimization

	ACTUAL		LIMIT			
Surface Area	888.000	>=	888	Length	Width	Height
				23.03	6.87	9.56
Footprint	158.123	<=	252			
Volume	1512.000	=>=	1512			
Width / Height	0.718	=<=	0.718		UNIT COST:	
					\$50.97	
Width / Height	0.718	>=	0.518			

The resulting 23.03 x 6.87 x 9.56 inch box is the lowest-cost design (\$50.97 per unit) that meets all the requirements of your various departments.

# Flow Network Modeling

File name: *FLOWNET.XLSX*

TYPE: *NONLINEAR*

## The Problem in Words

You are the manager of a network of pipelines and you need to determine a balance of flows along each arc of the network while satisfying demand at the nodes.

## Background

In the *FLOWNET* model, you have two supply nodes with connections to a total of six other nodes. The pressure at the supply nodes *G* and *H* is fixed at 240 lbs/square inch (PSI). There's a known demand at each of the six other nodes in C13:H13 of the *Arc Resistance* worksheet. You need to calculate the pressure at each node and the flow across each arc. The following diagram helps visualize this.

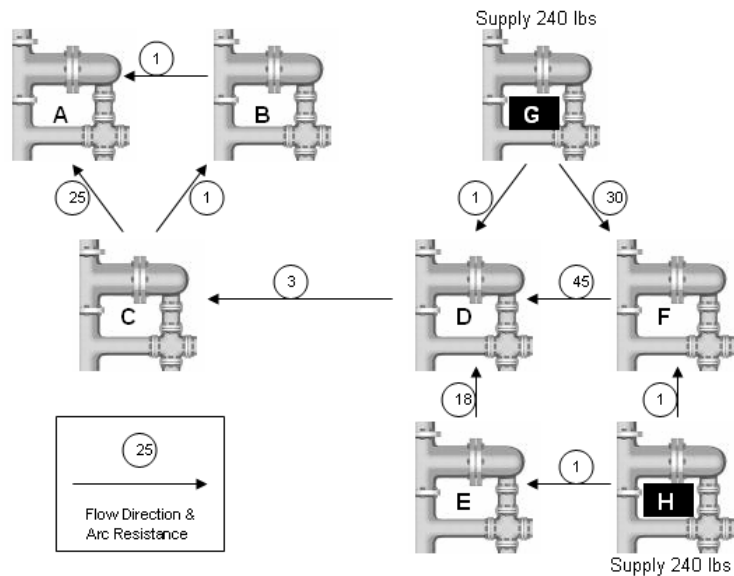



The Worksheet

The FLOWNET Model Before Solving

The screenshot shows an Excel spreadsheet with the following data:

		ARC RESISTANCE							
		Destination							
Origin:	A	B	C	D	E	F	G	H	
B									
C	1								
D	25	1							
E				3					
F					18				
G					45	12			
H					1		30		
						1	1		
Node Demand		1	2	4	6	8	7		
Node Pressure		0	0	0	0	0	0	240 240	

The worksheet has three tabs: ARC RESISTANCE, ARC FLOW, and PRESS. BALANCE. The status bar shows 'Ready' and '100%' zoom.

FLOWNET.xlsx - Microsoft Excel

File Home Insert Page Layout Formulas Data Review View Developer Team What'sBest! ?

A1

	A	B	C	D	E	F	G	H	I	J	K	L	M
1													
2						ARC FLOW							
3						Destination							
4						A	B	C	D	E	F	G	H
5	Origin:	A											
6		B	0.00										
7		C	0.00	0.00									
8		D			0.00								
9		E				0.00							
10		F				0.00	0.00						
11		G				0.00		0.00					
12		H					0.00	0.00					
13	Flow Conservation: Not = Not = Not = Not = Not = Not =												
14													
15													
16													
17													
18													
19													
20													
21													
22													

ARC RESISTANCE    **ARC FLOW**    PRESS. BALANCE

Ready    100%

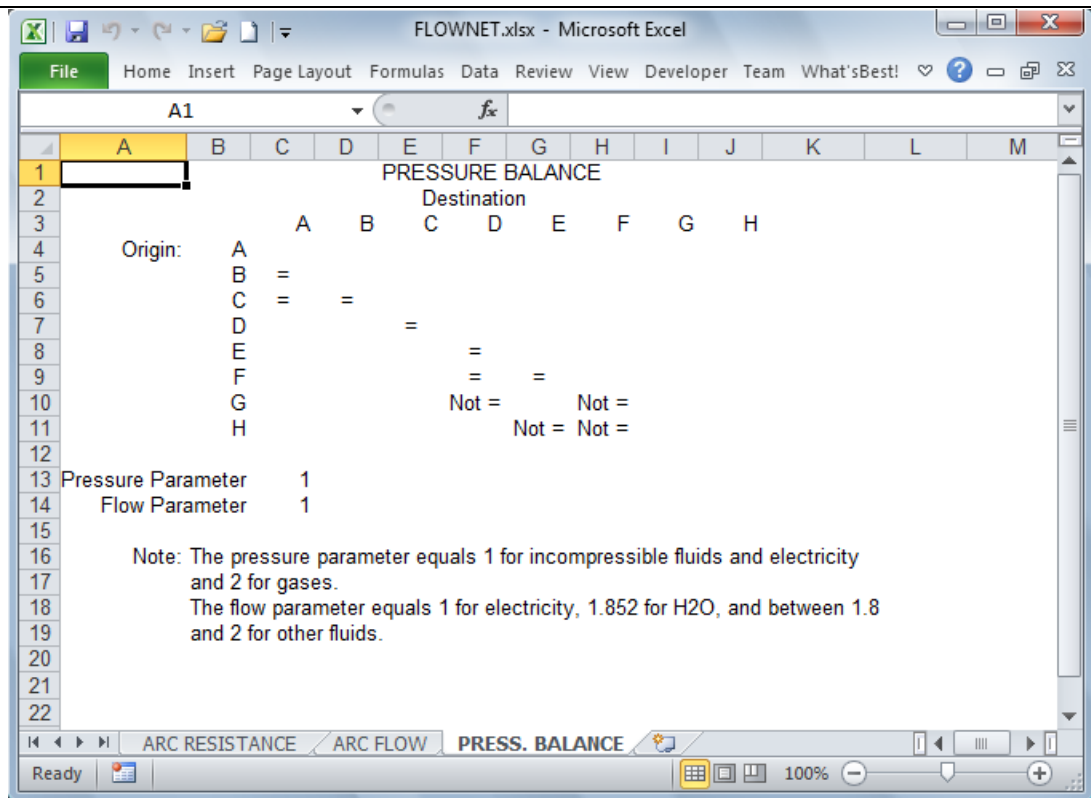

**A. Determine Adjustable Cells**

The adjustable cells are the *Pressures* at each *Node* (*Arc Resistance* C15:H15) and the *Flow* along each arc (the cells outlined above in the range C4:J11 of the *Arc Flow* worksheet).

To facilitate modeling the problem, nonadjustable zeroes have been entered for arcs where there is no flow. This increases the number of numeric cells in the model. In your own models, you may want to minimize the number of numeric cells.

**B. Define Best**

No best cell is defined in this example, since our objective is simply to balance the flows along the arcs and satisfy demand at the nodes.

**C. Specify Constraints**

The constraints in this model are twofold. First, conservation of flow requires that the amount entering an arc must equal the amount exiting that arc (*Arc Flow* C13:H13). As an example, here's the formula in C13:

$$WB(SUM(C4:C11), "=", 'ARC RESISTANCE!' C13+SUM(C4:H4))$$

Second, you must account for pressure lost along each arc due to resistance. These constraints are found in cells C5:H11 of the *Pressure Balance* worksheet. The formula in C5, for instance, requires that pressure applied equals pressure lost on the  $B \Rightarrow A$  arc:

$$WB('ARC RESISTANCE!' D14^{SC\$13} - 'ARC RESISTANCE!' C14^{SC\$13}, \\ "=" , 'ARC RESISTANCE!' C5 * 'ARC FLOW!' C5^{SC\$14})$$

Disregarding the exponents, which in this case are 1, the formula is:

$$WB('ARC RESISTANCE!' D14 - 'ARC RESISTANCE!' C14, "=", \\ 'ARC RESISTANCE!' C5 * 'ARC FLOW!' C5)$$

Thus, loss in pressure along arc  $B \Rightarrow A$  (pressure at  $B$  minus pressure at  $A$ ) must equal resistance along arc  $B \Rightarrow A$  times flow along arc  $B \Rightarrow A$ .

**Note:** The *Pressure* parameter is 1 for incompressible fluids and electricity and 2 for gases. The *Flow* parameter is 1 for electricity, 1.852 for  $H_2O$ , and between 1.8 and 2 for other fluids.

Now, you're ready to solve the model and determine the balance of flows. After solving, the *WB! Status* worksheet will open in order to show you the *Nonlinearity present* warning and *No Best Cell* warnings. These warnings may be turned off from the *General Options* dialog box. The three model worksheets now show the flows as shown below.

The *FLOWNET* Model After Solving

The screenshot shows an Excel window titled 'FLOWNET.xlsx - Microsoft Excel'. The active worksheet is 'ARC RESISTANCE'. The data is as follows:

		ARC RESISTANCE							
		Destination							
Origin:	A	B	C	D	E	F	G	H	
A									
B	1								
C	25	1							
D			3						
E				18					
F				45	12				
G				1		30			
H					1	1			
Node Demand		1	2	4	6	8	7		
Node Pressure		203	204	206	227	232	233	240	240

The status bar at the bottom shows 'Ready' and '100%' zoom. The worksheet tabs at the bottom are 'WB! Status', 'ARC RESISTANCE', 'ARC FLOW', and 'PRESS. BALANCE'.

FLOWNET.xlsx - Microsoft Excel

File Home Insert Page Layout Formulas Data Review View Developer Team What's Best! ?

A1

	A	B	C	D	E	F	G	H	I	J	K	L	M
1													
2						ARC FLOW							
3						Destination							
4					A	B	C	D	E	F	G	H	
5	Origin:	A											
6		B	0.85										
7		C	0.15	2.85									
8		D			7.00								
9		E				0.25							
10		F				0.13	0.10						
11		G				12.63		0.23					
12		H					8.15	6.99					
13	Flow Conservation:	=	=	=	=	=	=	=					
14													
15													
16													
17													
18													
19													
20													
21													
22													

WB! Status ARC RESISTANCE **ARC FLOW** PRESS. BALANCE

Ready 100%

FLOWNET.xlsx - Microsoft Excel

File Home Insert Page Layout Formulas Data Review View Developer Team What'sBest! ?

A1

	A	B	C	D	E	F	G	H	I	J	K	L	M
1													
2					PRESSURE BALANCE								
3					Destination								
4					A	B	C	D	E	F	G	H	
5	Origin:	A											
6		B	=										
7		C	=	=									
8		D			=								
9		E				=	=						
10		F				=	=	=					
11		G					=	=	=				
12		H						=	=				
13	Pressure Parameter			1									
14	Flow Parameter			1									
15													
16	Note: The pressure parameter equals 1 for incompressible fluids and electricity												
17	and 2 for gases.												
18	The flow parameter equals 1 for electricity, 1.852 for H2O, and between 1.8												
19	and 2 for other fluids.												
20													
21													
22													

WB! Status ARC RESISTANCE ARC FLOW PRESS. BALANCE

Ready 100%

# Bond Portfolio Optimization

File name: BONDS.XLSX

TYPE: LINEAR OPTIMIZATION FLOWNET

## Application Profile

This multi-period model is an example of dynamic modeling. “Dynamic” means that decisions made in this period affect not only this period’s returns (or costs), but future decisions and returns as well. For this reason, multi-period problems cannot be treated as if they were merely a collection of single-period problems.

In many multi-period modeling problems, liquid or cash-like assets are treated like other commodities, so holding cash is just like keeping inventory. The following illustrates the major features of multi-period models in a financial context.

## The Problem in Words

You’re a financial advisor for an investment firm. Your client needs enough cash to cover commitments for the next five years. You’ve concluded that to meet these financial obligations, he should invest in some very low-risk securities such as government bonds. You must recommend bonds to buy to minimize his total cost now, yet cover his cash flow requirements. This is also an example of how to defease debt — how to wipe it off the books.

## Background

Your client’s specific cash flow needs are as follows:

Year	0	1	2	3	4
<b>Cash Flow Need (\$M)</b>	\$17.0	\$62.0	\$23.0	\$35.0	\$62.0

In graph form, the data look like this:

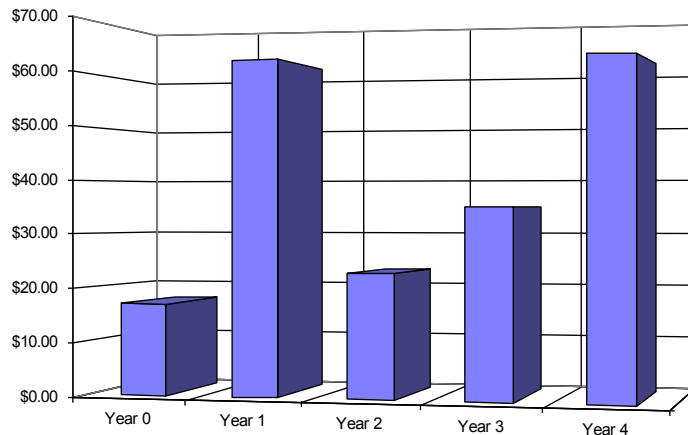



You've counseled your client to buy government bonds not only because of their low risk, but also because a bond owner receives a fixed set of cash payouts. For each year until the bond matures, your client receives an interest payment and, at maturity. He also gets back the face value or principal of the bond.

Generally, a broad spectrum of such investments are available on a given day. To keep it simple, let's assume you come across the following quotations for nine U.S. Treasury bonds:

<b>Year to Maturity</b>	<b>Asking Price (Rate/1000)</b>	<b>Interest Rate (%)</b>
1 Year	0.996	10.5
	0.997	10.5
2 Year	0.923	10.75
	0.987	11.2
3 Year	0.993	11.8
	1.061	12.0
	0.883	10.0
4 Year	1.102	12.6
	0.889	10.2

### Objective of Optimization

You want to minimize your client's initial investment, while covering his cash flow needs over the next five years. In other words, you wish to know the minimum amount of cash that should be allocated among all the available bonds, which will maintain the required cash inflow over the next five years.

## The Worksheet

To get started, let's examine the *BONDS* worksheet. Look it over for a minute to see how it's designed.

The *BONDS* Worksheet (Part 1) *Before Optimization*

The <i>BONDS</i> Worksheet (Part 1) <i>Before Optimization</i>							
BONDS.xlsx - Microsoft Excel							
File Home Insert Page Layout Formulas Data Review View Developer Team What's Best! ?							
A1 AVAILABLE							
A	B	C	D	E	F	G	H
1	AVAILABLE	Year of	Asking	Interest	Units	Investment/	
2	BOND OPTIONS:	Maturity	Price	Rate	Purchased	Bond Issue	Year of
3							Maturity
4		1	0.996	10.5	0.0	\$0.00	1
5			0.997	10.5	0.0	\$0.00	
6		2	0.923	10.75	0.0	\$0.00	2
7			0.987	11.2	0.0	\$0.00	
8		3	0.993	11.8	0.0	\$0.00	3
9			1.061	12	0.0	\$0.00	
10			0.883	10	0.0	\$0.00	
11		4	1.102	12.6	0.0	\$0.00	4
12			0.889	10.2	0.0	\$0.00	
13							
14					TOTAL COST:	\$0.00	
15							
16		Year 0	Year 1	Year 2	Year 3	Year 4	
17	Amount Covered	\$0.00	\$0.00	\$0.00	\$0.00	\$0.00	
18		Not >=	Not >=	Not >=	Not >=	Not >=	
19	Cash Flow Need	\$17.00	\$62.00	\$23.00	\$35.00	\$62.00	
20							
21							
22							

### A. Determine Adjustable Cells

Adjustable cells are the units of bonds purchased for each bond quoted (E4:E12).

### B. Define Best

The Best possible solution is the particular mix of units of bonds purchased that result in minimum initial investment in cell F14. Examine the formula for the *Total Cost* cell:  $SUM(F4:F12)$ . This formula sums the amount invested in each bond issued for each of the nine bonds offered.

### C. Specify Constraints

The constraints in this problem (B18:F18) require that the total cash inflows in B17:F17 (i.e., from the interest and/or principal income each year) remain greater-than-or-equal-to cash outflows needed per period in B19:F19.

The cells B17:F17, *Amount Covered*, contains formulas that add the cash received from bond interest payments as well as the repaid principal (when applicable) for each year. This *Income Stream* is detailed in cells I4:M12 and appears as follows:

The *BONDS* Worksheet (Part 2) *Before Optimization*

	F	G	H	I	J	K	L	M	N
1	AVAILABLE								
2	Investment/ Bond Issue		Year of Maturity	Year 0	Year 1	Year 2	Year 3	Year 4	
3									
4	\$0.00		1	0.0000	0.0000				
5	\$0.00			0.0000	0.0000				
6	\$0.00		2	0.0000	0.0000	0.0000			
7	\$0.00			0.0000	0.0000	0.0000			
8	\$0.00		3	0.0000	0.0000	0.0000	0.0000		
9	\$0.00			0.0000	0.0000	0.0000	0.0000		
10	\$0.00			0.0000	0.0000	0.0000	0.0000	0.0000	
11	\$0.00		4	0.0000	0.0000	0.0000	0.0000	0.0000	
12	\$0.00			0.0000	0.0000	0.0000	0.0000	0.0000	
13									
14	\$0.00								
15									
16	Year 4								
17	\$0.00								
18	Not >=								
19	\$62.00								
20									
21									
22									

For instance, suppose that in the beginning of year 0 your client invests in 10 units of a 10 percent 3 year U.S. Treasury bond (see the bond listed in C10:F10). A “10.0” would then be inserted in cell E10. Each unit represents a \$1000 face value or principal.

Thus, in the current year, your client will receive an interest payment of \$1.00, or 10 units \* .10 rate of interest, as calculated in cell I10 ( $E10 * D10 / 100$ ). Next year and the year after, he will continue to receive interest payments of \$1.00 (J10 and K10). In three years, when the bond matures, he will receive another interest payment of \$1.00 and additionally a repayment of the principal of 10 units, for a total of \$11.00 as calculated in cell L10 ( $E10 * (1 + D10 / 100)$ ).





# Lockbox Location

File name: LOCKBOX.XLSX

TYPE: LINEAR OPTIMIZATION

---

## The Problem in Words

As a corporate cash manager or officer of a bank whose clients must deal with the problem of optimizing collections from customers located at large distances from your home office, you must decide where to locate postal lockboxes, so that customers' deposits can be credited with a minimum of expense caused by mail delay (or "float time") while minimizing operating costs associated with the locations. In addition, each customer must be assigned to exactly one location.

## Background

Your customers, located in *Seattle*, *Los Angeles*, *Houston*, *Philadelphia*, and *Miami*, whose deposits must be credited with a minimum of float time, may be assigned to potential lockbox locations in *New York*, *Atlanta*, *Cincinnati*, *Denver*, or *St. Louis*. It may also be more cost-efficient to assign them to the home office.

## Objective of Optimization

Each customer must be assigned to a postal lockbox, so as to minimize the sum of float-time expense and monthly fixed operating costs.

---

## The Worksheet

Let's open the *LOCKBOX* sample file and look at its design and formulas.

### The *LOCKBOX* Worksheet *Before* Optimization

CHOOSE LOCKBOX LOCATIONS & CUSTOMER LOCKBOX ASSIGNMENTS							
Proposed Lockbox Locations							Monthly Cash Flow (\$000)
Customer Locations	New York	Atlanta	Cincinnati	Denver	Seattle	Home Office	
Seattle	0	0	0	0	0	0	5000
Los Angeles	0	0	0	0	0	0	5000
Houston	0	0	0	0	0	0	5000
Philadelphia	0	0	0	0	0	0	5000
Miami	0	0	0	0	0	0	5000
Open?	0	0	0	0	0	0	
Cost/Month:	\$1,300	\$975	\$1,000	\$1,100	\$2,000	\$0	
Fixed Costs	\$0	\$0	\$0	\$0	\$0	\$0	\$0
Variable Costs	\$0	\$0	\$0	\$0	\$0	\$0	\$0
Daily Cost of Capital:	0.027%						
TOTAL OPERATING COST:							\$0

AVERAGE MAIL DELAY BETWEEN LOCATIONS							
Customer Locations	New York	Atlanta	Cincinnati	Denver	Seattle	Home Office	Box?
Seattle	=>	=>	=>	=>	=>	=>	Not >=
Los Angeles	=>	=>	=>	=>	=>	=>	Not >=
Houston	=>	=>	=>	=>	=>	=>	Not >=

In cell C18, the *Daily Cost of Capital* is entered. In this example, the cost was calculated based on a hypothetical 10% annual rate for a 360-day year, prorated to .027% daily. This figure is important in calculating the expense due to float time caused by mail delay.

In H7:H11, the *Monthly Cash Flow* from each customer is shown. Cells B27:F31 display the average mail delay, in days, between customer sites and proposed lockbox locations. In G27:G31, the average delay from customer locations to the home office is found. Finally, in B14:G14, the fixed operating *Cost/Month* associated with each potential lockbox site is entered. Note that no fixed cost specific to the crediting of deposits is associated with the home office (cell G14), since this is part of the assumed cost of doing business.

### A. Determine Adjustable Cells

The adjustable cells indicate whether or not cash is to be routed from a given customer to a proposed lockbox location (B7:G11) and whether or not a lockbox is opened at a given site (B13:G13). These cells display a figure to show if a customer is assigned to a lockbox location (1) or not (0).

**B. Define Best**

The best cell is the sum of all operating and float costs in H19. A cost summary broken down into subtotals of fixed and variable costs is found in A15:H19. Let's look at the formulas used to determine these costs. Considering first the variable costs associated with a lockbox in New York City, the formula in cell B17 is:

$$(B7*B27*\$H\$7+B8*B28*\$H\$8+B9*B29*\$H\$9+B10*B30*\$H\$10+B11*B31*\$H\$11)*1000*\$C\$18$$

Thus, for the NYC lockbox, the average mail delay from each customer location (B27:B31) is multiplied by the cell indicating whether a lockbox has been assigned (B7:B11, a zero or a one), then by the amount of cash flow from the given customer location (H7:H11). The sum of these products is then multiplied by 1,000, to compensate for the fact that monthly cash flow figures are abbreviated by three digits, and by the *Daily Cost of Capital* in cell C18.

Fixed costs are calculated simply by multiplying the cost per month for each proposed lockbox (cell B14 in the case of NYC) by the cell indicating whether the location has been opened (B13).

These costs per location are added to produce subtotals in cells H15 and H17. The sum of the subtotals, *Total Operating Costs*, appears in H19, the objective cell.

**C. Specify Constraints**

The constraints are of two types. First, cells B40:G44 prevent a customer from being assigned to a location where no lockbox has been opened. For instance, move the cursor to cell B40 and observe the formula there (*WB* (B\$13, ">=", B7)). It requires that B13, a 1 or 0 depending on whether or not the New York lockbox is opened, be greater-than-or-equal-to B7, a 1 or 0 depending on whether or not the Seattle customer is assigned to the New York Lockbox. The value in B7 cannot be greater-than that in B13. If the Seattle customer is assigned to a lockbox located in New York, the location must be open or else the constraint in cell B40 will be unsatisfied.

The constraints in cells H40:H44 ensure that each customer is assigned to a lockbox by requiring that the sum of lockbox assignments for a given customer be at least 1.

---



With all constraints in place, we're ready to solve the model.

The LOCKBOX Worksheet After Optimization

The screenshot shows the 'LOCKBOX.xlsx' file in Microsoft Excel. The active cell is A1, containing the text 'CHOSEN LOCKBOX LOCATIONS & CUSTOMER'. The spreadsheet is divided into several sections:

- Section 1 (Rows 1-12):** 'CHOSEN LOCKBOX LOCATIONS & CUSTOMER LOCKBOX ASSIGNMENTS'. It lists 'Proposed Lockbox Locations' (Seattle, Los Angeles, Houston, Philadelphia, Miami) and 'Customer Locations' (New York, Atlanta, Cincinnati, Denver, Seattle, Home Office). A table shows the number of lockboxes assigned to each customer location from each proposed location. For example, Seattle is assigned 1 lockbox to Denver, and Philadelphia is assigned 1 lockbox to New York. The 'Monthly Cash Flow (\$000)' is listed as 5000 for each location.
- Section 2 (Rows 13-18):** Cost breakdown.
 

Open?	1	1	0	1	0	0	0
Cost/Month:	\$1,300	\$975	\$1,000	\$1,100	\$2,000	\$0	\$0
Fixed Costs	\$1,300	\$975	\$0	\$1,100	\$0	\$0	\$3,375
Variable Costs	\$1,350	\$1,350	\$0	\$5,400	\$0	\$0	\$8,100
Daily Cost of Capital:	0.027%						
- Section 3 (Row 19):** 'TOTAL OPERATING COST: \$11,475' (highlighted in blue).
- Section 4 (Rows 20-21):** 'AVERAGE MAIL DELAY BETWEEN LOCATIONS'.
- Section 5 (Rows 37-42):** Constraints for 'Box?'. It shows constraints for Seattle, Los Angeles, and Houston, with values like '>=' and '>= '.

After optimization, What'sBest! has returned a minimized cost of \$11,475 in cell H19 and the optimal solution recommends that lockboxes be opened in New York, Atlanta, and Denver.

**Note:** This model is an example of a class of models that returns naturally integer answers even though the adjustable cells have not been specified as integer. Since the use of 0/1 integer adjustable cells can cause dramatic increases in computation time, it is best to use naturally integer models whenever possible. Space here prohibits a detailed explanation of this phenomenon. Interested readers may refer to Chapter 8, *Introductions to Operations Research*, by Hillier & Lieberman, 7th ed., from McGraw-Hill, and to Chapter 14, *Optimization Modeling with LINGO*, by Linus Schrage, from Duxbury Press. The latter text is available from LINDO Systems. Call (312) 988-7422 for more information.

# Markowitz Portfolio Problem

File name: MARKOWIT.XLSX

TYPE: NONLINEAR OPTIMIZATION

---

## Application Profile

In the March, 1952, issue of *Journal of Finance*, Harry M. Markowitz published an article called *Portfolio Selection*. In it, he demonstrated how to reduce the standard deviation of returns on asset portfolios by selecting assets with prices that don't fluctuate in exactly the same ways. At the same time, he laid down some basic principles for establishing an advantageous relationship between risk and return, and his work is still in use forty years later.

## The Problem in Words

You're considering investing in three assets and historical data reveal that the return from each asset has fluctuated over time. You want to reduce variability, or risk, by spreading your investment over the three stocks.

## Background

From the historical data, you have calculated an expected return, the variance of the return rate, and the covariance of the return between the different assets. Variance is a measure of the fluctuation in the return — the higher the variance, the riskier the investment. The covariance is a measure of the correlation of return fluctuations of one stock with the fluctuations of another. High covariance indicates that an increase in one stock's return is likely to correspond to an increase in the other. A low covariance means the return rates are relatively independent and a negative covariance means that an increase in one stock's return is likely to correspond to a decrease in the other.

You have a target return of 15%. What percentages of your funds should you invest in each of the three assets to achieve this target and minimize the variance (or risk) of the portfolio? As an additional safety feature, you decide to invest no more than 75% in any single asset.

## Objective of Optimization

The objective is to determine the percent to invest in each asset while minimizing risk of the entire portfolio.

---

## The Worksheet

Let's look at the *MARKOWIT* sample file as supplied.

### The *MARKOWIT* Model *Before Solving*

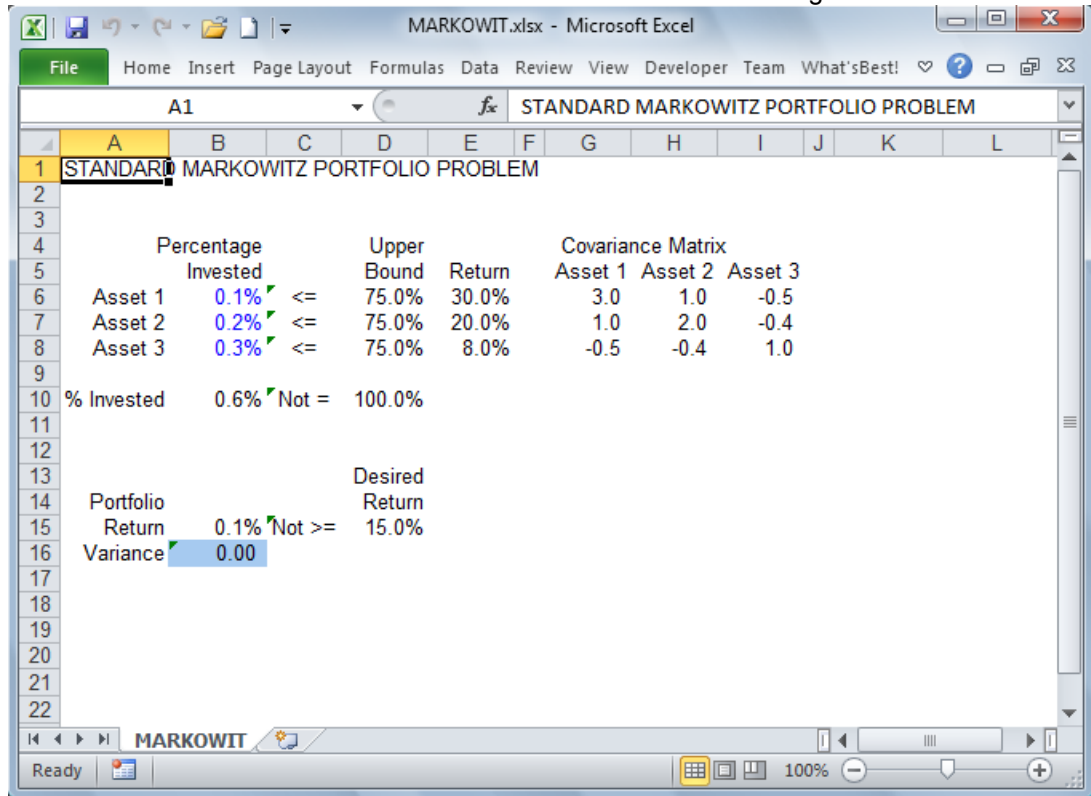

#### A. Determine Adjustable Cells

The adjustable cells are B6:B8, the *Percentages Invested* in each of the three stocks.

#### B. Define Best

The best solution is the one that minimizes the risk of the entire portfolio. In the Markowitz model, a portfolio's variance is used as the measure of risk. Using the variance gives a relatively greater penalty to outcomes that are far from the mean.

The variance of a portfolio is:

$$\sum_i \sum_j x_i x_j \sigma_{ij}$$

... where:

$x_i$  is the percentage invested in *Asset i*

$\sigma_{ij}$  for  $i \neq j$  is the covariance between *Assets i* and *j*

for  $i = j$  is the variance of *Asset i*

This is computed by means of the following formula in cell B16:

$$(G6*B6^2+G7*B6*B7+G8*B6*B8)+(H6*B7*B6+H7*B7^2+H8*B7*B8)+(I6*B6*B8+I7*B7*B8+I8*B8^2)$$

### C. Specify Constraints

There are three types of constraints in the Markowitz model. The first, in C6:C8, requires that no percentage invested in any single stock exceed the *Upper Bound* for each stock of 75% (D6:D8). For example, C6 has  $WB(B6, "<=", D6)$ .

The second, in C15, is  $WB(B15, ">=", D15)$ . This requires that the combined return on the three *Assets* (B15) be greater-than-or-equal-to the desired return in cell D15 (15%).

The third, in C10, is  $WB(B10, "=", D10)$ . This requires the sum of the percentages invested in each stock (B10) add up to 100% (D10).

Now, let's solve the model. After solving, the *WB! Status* worksheet will open in order to show you the *Nonlinearity present* warning. (This warning can be shut off from the *General Options* dialog box.) Your solved model now appears as follows.

The MARKOWIT Model After Solving

	Percentage Invested	Upper Bound	Return	Covariance Matrix		
				Asset 1	Asset 2	Asset 3
Asset 1	18.3%	<= 75.0%	30.0%	3.0	1.0	-0.5
Asset 2	24.8%	<= 75.0%	20.0%	1.0	2.0	-0.4
Asset 3	56.9%	<= 75.0%	8.0%	-0.5	-0.4	1.0
% Invested	100.0%	= 100.0%				
Portfolio Return	15.0%	>= 15.0%				
Variance	0.42					
Desired Return			15.0%			

What's *Best!* returns a minimized variance of 0.42.

An interesting exercise is to solve this model for different levels of *Desired Return* in cell D15, recording the portfolio variance at each step. A graph of the resulting data, illustrating the tradeoff between risk and return, is called the efficient frontier.

---

---

# Portfolio with Transaction Costs

File name: PORTCOST.XLSX

TYPE: NONLINEAR OPTIMIZATION

---

## Application Profile

As the expected return and variances of each asset change, the optimal portfolio is almost certain to change. Adjusting your investments with every change may cheer up your broker, but the commissions or transaction costs will slowly erode the value of your portfolio. Typically, there's a cost associated with each sale or purchase. Using this model, you need to take these transaction costs into account in calculating how to adjust your portfolio.

## The Problem in Words

According to your estimates, your current holdings will yield a 12.2% return. You are interested in adjusting your portfolio to lower the variance, yet achieve a return of at least 9.5%.

## Background

Your portfolio currently consists of 50% of *Asset 1*, 30% of *Asset 2*, and 20% of *Asset 3*. You pay a transaction fee at the beginning of the period that is a percentage of the amount bought or sold. The transaction fee is 1.0% for *Asset 1*, 1.5% for *Asset 2*, and 2.0% for *Asset 3*. You have estimated the expected return and the covariance terms for each asset.

## Objective of Optimization

The objective is to determine the percent to invest in each asset while minimizing the risk of the entire portfolio.

---

## The Worksheet

Let's look at the *PORTCOST* sample file.

### The *PORTCOST* Model *Before Solving*

Transaction Cost						
	Return	Rate	Begin	Sold	Bought	End
Asset 1	9.0%	1.0%	50.0%	0.0%	0.0%	50.0%
Asset 2	13.5%	1.5%	30.0%	0.0%	0.0%	30.0%
Asset 3	18.0%	2.0%	20.0%	0.0%	0.0%	20.0%

Covariance Matrix			End Value	Desired
Asset 1	Asset 2	Asset 3	Port. + Return	End Value
Asset 1	25.0	2.5	112.2%	>= 109.5%
Asset 2	2.5	150.0	Proceeds	Cost of
Asset 3	0.0	40.0	From Sales	Buys
Variance	35.54		0.0%	=>= 0.0%

#### A. Determine Adjustable Cells

The adjustable cells are the percentages of each asset to be *Bought* or *Sold*, in cells E7:F9.

#### B. Define Best

The best solution minimizes the variance of the portfolio. This is accomplished in cell B18 by means of the following formula explained in the previous sample model:

$$(G7^2*B14+G7*G8*B15+G7*G9*B16)+(G8*G7*C14+G8^2*C15+G8*G9*C16)+(G9*G7*D14+G9*G8*D15+G9^2*D16)$$

#### C. Specify Constraints

Cell E13 calculates the value of the ending portfolio plus the return over the period with the formula:

$$(1+B7)*G7+(1+B8)*G8+(1+B9)*G9$$

The constraint in cell F13,  $WB(E13,">=",G13)$ , ensures that the *End Value Port. + Return* (E13) is greater-than-or-equal-to the *Desired End Value* (G13) of 109.5% of the original portfolio value.

The cash required to buy any asset must come from selling some asset. The *Proceeds From Sales* is calculated in E17 by the formula:

$$E7*(1-\$C\$7)+E8*(1-\$C\$8)+E9*(1-\$C\$9)$$

The constraint in cell F17,  $WB(E17,">=",G17)$ , requires the *Proceeds from Sales* to be at least as great as the *Cost of Buys* in G17, calculated by the formula:

$$F7*(1+\$C\$7)+F8*(1+\$C\$8)+F9*(1+\$C\$9)$$

Now, let's solve the model. After solving, the *WB! Status* worksheet will open in order to show you the *Nonlinearity present* warning. (This warning can be shut off from the *General Options* dialog box.) Your solved model now appears as follows:

The PORTCOST Model After Solving

Transaction Cost						
	Return	Rate	Begin	Sold	Bought	End
Asset 1	9.0%	1.0%	50.0%	0.0%	28.1%	78.1%
Asset 2	13.5%	1.5%	30.0%	17.6%	0.0%	12.4%
Asset 3	18.0%	2.0%	20.0%	11.3%	0.0%	8.7%

Covariance Matrix				End Value	Desired
	Asset 1	Asset 2	Asset 3	Port. + Return	End Value
Asset 1	25.0	2.5	0.0	109.5%	=>= 109.5%
Asset 2	2.5	150.0	40.0	Proceeds	Cost of
Asset 3	0.0	40.0	256.0	From Sales	Buys
Variance	20.85			28.4%	=>= 28.4%

In the optimal solution, you are holding 78.1% of *Asset 1*, 12.4% of *Asset 2*, and 8.7% of *Asset 3*. These amounts are percentages of the value of your original portfolio. You may notice that the percentages add to only 99.2% rather than 100%. This is because .8% of the value of the original portfolio has gone to the transaction costs required to shift your investment levels. Note also that the variance has been lowered to 20.85 from 35.54.



---

# Portfolio - Minimizing Downside Risk

File name: DNRISK.XLSX

TYPE: NONLINEAR OPTIMIZATION

---

## Application Profile

An obvious objective and common strategy in investing is to minimize the risk of losing ground. This model demonstrates how to accomplish this.

## The Problem in Words

You're considering investing in three different assets. You need to determine how much to invest in each of three assets to minimize the risk of having to sell your baseball cards.

## Background

You have forecasts for the expected return of each asset under seven equally likely scenarios — there is a transportation strike, interest rates rise or fall, crops fail, Cubs win the World Series, Bulls win NBA finals, etc. You know that if you invest 100% of your capital in *Asset 2*, the average return under all possible scenarios (your expected return) is 19.9%.

You plan to live on the return from your portfolio. After figuring your living expenses, you find that a return below 11% will force you to start selling off your beloved baseball card collection to live in the manner to which you've become accustomed. Call that 11% your threshold return.

The return on *Asset 2* is below your threshold return of 11% in a couple of scenarios, and under *Scenario 7* you actually lose money on your portfolio—perhaps forcing you to sell the entire baseball card collection. While the 19.9% return is very appealing, the thought of parting with even some of your baseball cards is frightening. You've decided you would like an average or expected return of at least 13% (call this your desired return), but you want to minimize the likelihood that you'll have to sell off some of those valuable cards.

## Objective of Optimization

The objective is to invest for a profit while minimizing the risk of diminishing your baseball card collection.

---

## The Worksheet

Let's look at the *DNRISK* sample file.

The *DNRISK* Worksheet Before Solving

Scenario	Stock 1	Stock 2	Stock 3	Scenario Return	Downside Risk	Forcing Constraints
1	0.0%	0.0%	0.0%	0.0%	0.0%	Not >=
2	-7.1%	14.4%	16.9%	0.0%	0.0%	Not >=
3	5.6%	10.7%	-3.5%	0.0%	0.0%	Not >=
4	3.8%	32.1%	13.3%	0.0%	0.0%	Not >=
5	8.9%	30.5%	73.2%	0.0%	0.0%	Not >=
6	9.0%	19.5%	2.1%	0.0%	0.0%	Not >=
7	8.3%	39.0%	13.1%	0.0%	0.0%	Not >=
8	3.5%	-7.2%	0.6%	0.0%	0.0%	Not >=
Average Return		Desired Return	Threshold Return	Budget Investment Equals 100 Percent?		
0.0%		13.0%	11.0%	Not =		
Average Squared Downside Risk		0.0000%				

**A. Determine Adjustable Cells**

The adjustable cells are the percentages of your capital to invest in each of the three assets, in cells C4:E4, and the percentages of *Downside Risk* for each *Scenario* in cells G6:G12.

**B. Define Best**

The best cell is the average of the sum of the squares of the downside risk percentages (D19). The sum of squares is used to increase the relative penalty on outcomes that are far below the return threshold.

**C. Specify Constraints**

There are three kinds of constraints in this model.

The *Forcing Constraints* in I6:I12 force the *Downside Risk* for each *Scenario* to be either the *Threshold Return* minus *Scenario Return* when the *Scenario Return* is less-than the *Threshold Return*, or zero when the *Scenario Return* is more than the *Threshold Return*. For example, the formula in I6 is:

$$WB(G6,">=",$E$16-F6)$$

Since G6 is an adjustable cell, which is prohibited from returning a negative value, and since this is a minimization problem, it will return the smallest possible nonnegative value. If E16 (*Threshold Return*) is less-than F6 (*Scenario Return*), E16-F6 is a negative number — so the constraint will be satisfied by zero, which is greater-than any negative number.

The constraint in H16 forces the sum of percentages invested in each stock to be 100.

The constraint in C16 forces the average return for the scenarios to be greater-than-or-equal-to the *Desired Return*.

Now, let's solve the model. After solving, the *WB! Status* worksheet will open in order to show you the *Nonlinearity present* warning. (This warning can be shut off from the *General Options* dialog box.) Your solved model now appears as follows.

The *DNRISK* Worksheet After Solving

Scenario	Stock 1	Stock 2	Stock 3	Scenario Return	Downside Risk	Forcing Constraints
1	-7.1%	14.4%	16.9%	0.0%	100.0%	>=
2	5.6%	10.7%	-3.5%	0.0%	100.0%	>=
3	3.8%	32.1%	13.3%	0.0%	100.0%	>=
4	8.9%	30.5%	73.2%	0.0%	100.0%	>=
5	9.0%	19.5%	2.1%	0.0%	100.0%	>=
6	8.3%	39.0%	13.1%	0.0%	100.0%	>=
7	3.5%	-7.2%	0.6%	0.0%	100.0%	>=
Average Return	0.0%	Not >=	Desired Return 13.0%	Threshold Return 11.0%	Budget Investment Equals 100 Percent?	Not =
Average Squared Downside Risk		100.0000%				

The *Average Squared Downside Risk* in cell D19 has been minimized to .2828%.

# Portfolio - Scenario Model

File name: PORTSCEN.XLSX

TYPE: NONLINEAR OPTIMIZATION

---

## The Problem in Words

There are a variety of ways to measure the risk of a portfolio. In this model, you need to observe the changes in the optimal investment allocations resulting from the minimization of risk as measured in three different ways and determine the best measure of risk for your lifestyle.

## Background

Once again, there are three assets, this time with twelve equally likely expected return scenarios. Scenarios are outcomes of events with an influence on your analysis: Fed raises interest rates by 0.5 point, Fed lowers interest rates by 0.25 point, housing starts up, etc. This model calculates three different measures of risk: variance, semi-variance, and downside risk. You can minimize each of the three and get different levels of each asset that achieve your target return of 15% — each offers the “lowest risk”, depending on which of the three measures you select.

*Variance* is a measure of the fluctuation of the expected return. However, this measure of risk considers a scenario that returns 5% *above* the target to be as desirable as a scenario that returns 5% *below* the target. You’re probably only worried about the risk that the return will be below your target return.

Both *Semi-variance* and *downside risk* look only at the risk that your return will be below the target. Downside risk minimizes the difference between the target and returns below the target. The semi-variance minimizes the difference between the target and the square of the returns below the target. Therefore, it puts a higher weight on larger differences below the target.

## Objective of Optimization

The objective is to determine the percent to invest in each asset while minimizing the risk of the entire portfolio using the risk measure that is most important to you.

---

## The Worksheet

Let's look at the supplied *PORTSCEN* sample file:

### The *PORTSCEN* Worksheet Before Solving

	A	B	C	D	E	F	G	H	I	J	K	L
1	PORTFOLIO SCENARIO MODEL											
2		Asset 1	Asset 2	Asset 3	Prob.	Return		Difference		Forcing		
3	Scenario	0.0%	0.0%	0.0%			Over	Under	Constraints			
4	1	130.0%	122.5%	114.9%	8.3%	0.0%	0.0%	0.0%	Not =			
5	2	110.3%	129.0%	126.0%	8.3%	0.0%	0.0%	0.0%	Not =			
6	3	121.6%	121.6%	141.9%	8.3%	0.0%	0.0%	0.0%	Not =			
7	4	95.4%	72.8%	92.2%	8.3%	0.0%	0.0%	0.0%	Not =			
8	5	92.9%	114.4%	116.9%	8.3%	0.0%	0.0%	0.0%	Not =			
9	6	105.6%	107.0%	96.5%	8.3%	0.0%	0.0%	0.0%	Not =			
10	7	103.8%	132.1%	113.3%	8.3%	0.0%	0.0%	0.0%	Not =			
11	8	108.9%	130.5%	173.2%	8.3%	0.0%	0.0%	0.0%	Not =			
12	9	109.0%	119.5%	102.1%	8.3%	0.0%	0.0%	0.0%	Not =			
13	10	108.3%	139.0%	113.1%	8.3%	0.0%	0.0%	0.0%	Not =			
14	11	103.5%	92.8%	100.6%	8.3%	0.0%	0.0%	0.0%	Not =			
15	12	117.6%	171.5%	190.8%	8.3%	0.0%	0.0%	0.0%	Not =			
16												
17	Expected Return =	0.0%										
18	Target Return	115.0%			Variance =	0.0000						
19	Return > Target	Not >=			Semi-Variance =	0.0000						
20	Invest Total 100%	Not =			Downside Risk =	0.0000						
21												
22												

### A. Determine Adjustable Cells

The adjustable cells in the model are the percentages of capital invested in each *Asset* (B3:D3), and the differences *Over* and *Under* in G4:H15. The *Overs* are forced to be the amount by which a *Return* is greater-than the *Expected Return*. The *Unders*, similarly, are the amount by which a *Return* is less-than the *Expected Return*. These adjustable cells are forced to take these values by the constraints in I4:I15, which we explain in detail under *C. Specify Constraints* below.

### B. Define Best

You can choose one of three best cells in this model. We'll show solutions for all three minimization objectives:

- ◆ Variance in H18,
- ◆ Semi-Variance in H19, and
- ◆ Downside Risk in H20.

The *Variance* is calculated in H18 with the formula:

$$\begin{aligned} &E4*(G4+H4)^2+E5*(G5+H5)^2+E6*(G6+H6)^2+E7*(G7+H7)^2+E8 \\ &*(G8+H8)^2+E9*(G9+H9)^2+E10*(G10+H10)^2+E11*(G11+H11)^2 \\ &+E12*(G12+H12)^2+E13*(G13+H13)^2+E14*(G14+H14)^2+E15 \\ &*(G15+H15)^2 \end{aligned}$$

This is equivalent to the sumproduct of the probabilities and the squared values of the difference between *Return* and *Target Return*.

The *Downside Risk* is calculated as the sumproduct of the probabilities in *Column E* and the *Unders* in *Column H*. The *Semi-variance* is formulated as the sumproduct of the probabilities and the squares of the *Unders*.

### C. Specify Constraints

There are three types of constraints in the *PORTSCEN* model. The first requires a bit of thought.

The *Forcing Constraints* in I4:I15 force the difference between *Over* (G4:G15) and *Under* (H4:H15) to be equal-to the difference between the *Expected Return* (F17) and *Return* (F4:F15). For instance, in I4 the formula is: `WB(G4-H4,"=",F4-$C$17)`.

To find the semi-variance and downside risk, we need to calculate the amount by which each *Scenario Risk* (*SR*) is below the *Target Return* (*TR*). A shrewd spreadsheet builder will recognize that this calculation can be done using an *IF* function of the form:

$$IF(SR < TR, TR - SR, 0)$$

This function returns the difference between the target return and the scenario return if the scenario return is less-than the target return. Otherwise, it returns zero.

The bend at the origin of this *IF* statement makes it a non-smooth function. A smooth function has no breaks or sharp bends. Most *IF* functions that depend directly or indirectly on adjustable cells are non-smooth, and it's wise to avoid non-smooth functions, since they can be difficult to solve reliably (see Chapter 7, *Overview of Mathematical Modeling*, for a discussion of non-smooth relationships).

By adding adjustable cells and carefully formulated constraints, it turns out, you can avoid the need for most non-smooth *IF* functions. You can choose to use *IF* functions instead of finding ways around them, but you run the risk of suboptimal answers from the solver.

In this case, we've emulated the *IF* function using two adjustable cells and one constraint. For each of the scenarios, we've added an adjustable cell in columns *G* and *H*. Then, we use a constraint to force the adjustable cell in column *G* to be equal-to the amount the scenario return is *Over* the target return, or zero if the return is less-than the target. The adjustable cell in column *H* is likewise required to be equal-to the amount the scenario return is *Under* the target return, or zero if the return is greater-than the target.

The constraints in cells I4:I15 force the difference between the adjustable cells G4:H15 to equal the difference between the return for this scenario (F4:F15) and the *Target Return* (C19).

For example, for scenario 1 the constraint in cell I4 reads:  $WB(G4-H4,"=",F4-\$C\$18)$ . If *Target Return* (C18) is 115% and the scenario return (F4) is 120%, the constraint forces G4-H4 to be equal-to 5%. As adjustable cells, G4 and H4 are implicitly nonnegative. Since the objective is to minimize a function of these adjustable cells, they're forced to the smallest values that satisfy all constraints. Thus, G4 will be forced to 5% and H4 will be forced to 0%. Similarly, if the scenario return (F4) is 110%, then the constraint forces G4-H4 to return -5%. G4 is forced to 0% and H4 to 5%. If you experiment with the asset allocations in cells G4:H15, you can confirm that the forcing constraints work properly.

In C19, the constraint formula:  $WB(C17,">=",C18)$  forces the *Expected Return* in C17 to be at least as great as the *Target Return* in C18. In C20, a constraint requires that 100 percent of the funds are invested. That is, that B3:D3 sum to 1.

Now, you're ready to solve the model. After solving, the *WB! Status* worksheet will open in order to show you the *Nonlinearity present* warning. (This warning can be disabled from the *General Options* dialog box.) The solutions for all three objectives follow.

The *PORTSCEN* Worksheet After Minimizing Variance

Scenario	Asset 1	Asset 2	Asset 3	Prob.	Return	Difference Over	Difference Under	Forcing Constraints
1	130.0%	122.5%	114.9%	8.3%	125.4%	10.4%	0.0%	=
2	110.3%	129.0%	126.0%	8.3%	118.8%	3.8%	0.0%	=
3	121.6%	121.6%	141.9%	8.3%	124.4%	9.4%	0.0%	=
4	95.4%	72.8%	92.2%	8.3%	87.3%	0.0%	27.7%	=
5	92.9%	114.4%	116.9%	8.3%	103.4%	0.0%	11.6%	=
6	105.6%	107.0%	96.5%	8.3%	104.8%	0.0%	10.2%	=
7	103.8%	132.1%	113.3%	8.3%	114.7%	0.0%	0.3%	=
8	108.9%	130.5%	173.2%	8.3%	125.0%	10.0%	0.0%	=
9	109.0%	119.5%	102.1%	8.3%	111.6%	0.0%	3.4%	=
10	108.3%	139.0%	113.1%	8.3%	119.3%	4.3%	0.0%	=
11	103.5%	92.8%	100.6%	8.3%	99.5%	0.0%	15.5%	=
12	117.6%	171.5%	190.8%	8.3%	145.8%	30.8%	0.0%	=

Expected Return =	115.0%	Variance =	0.0211
Target Return	115.0%	Semi-Variance =	0.0105
Return > Target	>=	Downside Risk =	0.0572
Invest Total 100%	=		

Variance minimizes to .0211.

Solutions for downside risk and semi-variance appear below.

The *PORTSCEN* Worksheet After Minimizing Semi-Variance

Scenario	Asset 1	Asset 2	Asset 3	Prob.	Return	Difference Over	Difference Under	Forcing Constraints
1	46.8%	0.1%	53.0%	8.3%	122.0%	7.0%	0.0%	=
2	110.3%	129.0%	126.0%	8.3%	118.7%	3.7%	0.0%	=
3	121.6%	121.6%	141.9%	8.3%	132.4%	17.4%	0.0%	=
4	95.4%	72.8%	92.2%	8.3%	93.7%	0.0%	21.3%	=
5	92.9%	114.4%	116.9%	8.3%	105.7%	0.0%	9.3%	=
6	105.6%	107.0%	96.5%	8.3%	100.8%	0.0%	14.2%	=
7	103.8%	132.1%	113.3%	8.3%	108.9%	0.0%	6.1%	=
8	108.9%	130.5%	173.2%	8.3%	143.0%	28.0%	0.0%	=
9	109.0%	119.5%	102.1%	8.3%	105.4%	0.0%	9.6%	=
10	108.3%	139.0%	113.1%	8.3%	110.9%	0.0%	4.1%	=
11	103.5%	92.8%	100.6%	8.3%	101.9%	0.0%	13.1%	=
12	117.6%	171.5%	190.8%	8.3%	156.5%	41.5%	0.0%	=
17	Expected Return =		116.6%					
18	Target Return		115.0%		Variance =	0.0328		
19	Return > Target		>=		Semi-Variance =	0.0089		
20	Invest Total 100%		=		Downside Risk =	0.0649		

After solving, the semi-variance is minimized to .0089.



The PORTSCEN Worksheet After Minimizing Downside Risk

Scenario	Asset 1	Asset 2	Asset 3	Prob.	Return	Difference Over	Difference Under	Forcing Constraints
1	130.0%	122.5%	114.9%	8.3%	116.8%	1.8%	0.0%	=
2	110.3%	129.0%	126.0%	8.3%	125.3%	10.3%	0.0%	=
3	121.6%	121.6%	141.9%	8.3%	138.0%	23.0%	0.0%	=
4	95.4%	72.8%	92.2%	8.3%	90.0%	0.0%	25.0%	=
5	92.9%	114.4%	116.9%	8.3%	115.0%	0.0%	0.0%	=
6	105.6%	107.0%	96.5%	8.3%	98.4%	0.0%	16.6%	=
7	103.8%	132.1%	113.3%	8.3%	115.0%	0.0%	0.0%	=
8	108.9%	130.5%	173.2%	8.3%	163.6%	48.6%	0.0%	=
9	109.0%	119.5%	102.1%	8.3%	104.7%	0.0%	10.3%	=
10	108.3%	139.0%	113.1%	8.3%	116.0%	1.0%	0.0%	=
11	103.5%	92.8%	100.6%	8.3%	99.8%	0.0%	15.2%	=
12	117.6%	171.5%	190.8%	8.3%	183.6%	68.6%	0.0%	=

Expected Return =	122.2%		
Target Return	115.0%	Variance =	0.0745
Return > Target	>=	Semi-Variance =	0.0103
Invest Total 100%	=	Downside Risk =	0.0559

Minimized downside risk comes to .0559.

Minimization of the three measures of risk yield the following portfolios:

	Asset 1	Asset 2	Asset 3
<b>Minimize Variance</b>	52.5%	33.9%	13.6%
<b>Minimize Semi-Variance</b>	46.8%	.1%	53.1%
<b>Minimize Downside Risk</b>	6.6%	12.4%	81.0%

It is interesting to observe that, although minimizing all three measures of risk (*Variance*, *Semi-variance*, and *Downside Risk*) individually produces a similar level of risk, it also produces rather different portfolio allocation and expected returns. This illustrates why it is important to consider the measure of risk that is most appropriate for your investment goals.

# Seasonal Sales Factoring

File name: SEASON.XLSX

TYPE: NONLINEAR OPTIMIZATION

## The Problem in Words

You sell a seasonal product and you would like to find out how the seasons affect sales and your sales growth. This information would help you in forecasting sales and making future ordering decisions.

## Background

This model calculates seasonal factors that measure the effect each season has on sales and fits a straight line to the normalized data by minimizing the squared error. The *trend*, or slope of the line, is the sales growth per season. The *base* is the sales figure at time zero. You have the sales data by season for the last two years:

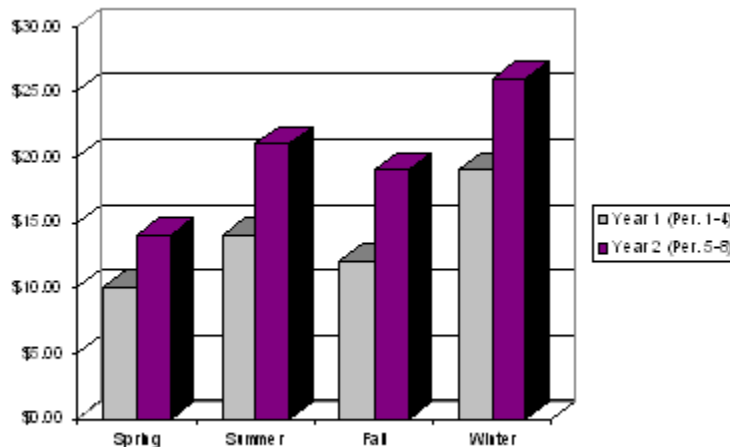

## Objective of Optimization

The objective is to predict sales for the next two years based on the *Base*, *Trend*, and *Seasonal Factors* while minimizing the error.

## The Worksheet

Let's look at the *SEASON* sample file.

### The *SEASON* Worksheet Before Solving

Season	Period	Sales (\$1000's)	Predicted	Error
Spring	1	\$10.00	\$0.00	-10.00
Summer	2	\$14.00	\$0.00	-14.00
Fall	3	\$12.00	\$0.00	-12.00
Winter	4	\$19.00	\$0.00	-19.00
Spring	5	\$14.00	\$0.00	-14.00
Summer	6	\$21.00	\$0.00	-21.00
Fall	7	\$19.00	\$0.00	-19.00
Winter	8	\$26.00	\$0.00	-26.00

Seasonal Factors:	
Spring	0.00
Summer	0.00
Fall	0.00
Winter	0.00
Average	0.00 Not = 1.00

Trend	\$0.00
Base	\$0.00
Sum of Squared Error =	2475.000

### A. Determine Adjustable Cells

The adjustable cells in the model are the *Trend* in B15, the *Base* in B16, and the four *Seasonal Factors* in E15:E18.

### B. Define Best

The best cell is the *Sum of Squared Error* in B19. The formula there is:

$$\text{SUMPRODUCT}(E5:E12, E5:E12)$$

This is the sum of the range of *Errors* in E5:E12 squared.

### C. Specify Constraints

The only constraint (F19) is the requirement that the *Seasonal Factors* average to 1. This is enforced by the formula:

$$\text{WB}(E19, "=", G19)$$

where E19 contains  $\text{AVERAGE}(E15:E18)$ .

The equations to calculate the predicted points (D5:D12) are of the form:

$$\text{Predicted} = \text{Seasonal Factor} * (\text{Base Point} + \text{Period} * \text{Trend})$$

The *Error* terms are the *Predicted* points minus the *Sales* data points. For example, the *Error* for *Spring* of *Period 1* in E5 is found with D5-C5.

Now, let's solve the model. After solving, the *WB! Status* worksheet will open in order to show you the *Nonlinearity present* warning. (This warning can be disabled from the *General Options* dialog box.) Your solved model now appears as follows:

**The SEASON Worksheet After Solving**

SEASON SALES					
	Season	Period	Sales (\$1000's)	Predicted	Error
5	Spring	1	\$10.00	\$9.31	-0.69
6	Summer	2	\$14.00	\$14.10	0.10
7	Fall	3	\$12.00	\$12.85	0.85
8	Winter	4	\$19.00	\$18.81	-0.19
9	Spring	5	\$14.00	\$14.44	0.44
10	Summer	6	\$21.00	\$20.93	-0.07
11	Fall	7	\$19.00	\$18.40	-0.60
12	Winter	8	\$26.00	\$26.14	0.14
			Seasonal Factors:		
15	Trend	\$1.55	Spring	0.83	
16	Base	\$9.72	Summer	1.10	
			Fall	0.89	
			Winter	1.18	
18	Sum of Squared		Average	1.00	= 1.00
19	Error =	1.823			

The spring seasonal factor is .83. In other words, spring sales are 83% of the average season. The trend of the solved model is \$1.55. This means that, after the effects of season are taken into account, sales are increasing at an average rate of \$1,550 per season.

Actual sales compared to predicted sales are shown in the graph below:

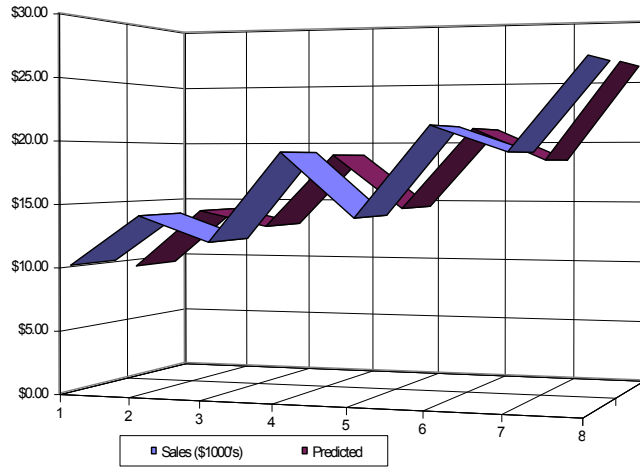

---

# Exponential Smoothing

File name: SIMXPO.XLSX, SMOOTH.XLSX

TYPE: NONLINEAR OPTIMIZATION

---

## Application Profile

Exponential smoothing is one technique that you can use to predict events in the future by studying events in the past. By employing weighted averages to “smooth” past values, it lets you forecast the value in the next period.

The basic model for exponential smoothing is:

$$P_{t+1} = P_t + \alpha * (Y_t - P_t)$$

where

$P_{t+1}$  = predicted value at period  $(t+1)$

$P_t$  = predicted value in period  $t$

$Y_t$  = actual value at period  $t$

$\alpha$  (alpha) = the smoothing constant

If *Alpha* is set to 1, the forecast for the next period is based entirely on the actual value from the last period. If *Alpha* is set to 0, the actual value from the last period is completely ignored. Since neither of these cases will provide much insight into future data, we’ll constrain *Alpha* to be between .01 and .99.

## The Problem in Words

In order to minimize costly overstocking and inventory holding, your retail outlet needs useful predictions of future sales.

## Background

For this simple exponential smoothing problem, you have sales data (in \$1,000’s) for eight months. You need to find *Alpha*, the smoothing constant, that minimizes the sum of the error, which in this case is the difference between the actual and predicted sales for each period.

## Objective of Optimization

The objective is to determine projected sales and the *Alpha* smoothing constant while minimizing the squared error.

---

## The Worksheet

Let's look at the supplied sample file called *SIMXPO*.

### The *SIMXPO* Worksheet Before Solving

Period	Sales	Predicted	Squared Error
1	\$10	10.000	0.000
2	\$14	0.000	196.000
3	\$12	0.000	144.000
4	\$19	0.000	361.000
5	\$14	0.000	196.000
6	\$21	0.000	441.000
7	\$19	0.000	361.000
8	\$26	0.000	676.000
Sum =			2375.000
Alpha	0.000	Not >=	
Lower bound	Not >=		
Upper bound	<=		

#### A. Determine Adjustable Cells

The adjustable cells are the *Predicted* sales in C5:C11, and the *Alpha* smoothing term in C14. Note that *Period 1* in cell C4 is fixed at 10, since there is no previous period on which to base a prediction.

#### B. Define Best

The best cell is the minimized *Sum of Squared Errors* (differences between *Sales* and *Predicted* in cells E4:E11) in E13.

#### C. Specify Constraints

The constraints in D5:D11 reproduce the basic model for exponential smoothing (see preceding page) for each *Predicted* period. In C15:C16, the *Alpha* term is bounded by .001 and .999.

Now, you are ready to solve the model. After solving, the *WB! Status* worksheet will open in order to show you the *Nonlinearity present* warning. (This warning can be disabled from the *General Options* dialog box.) Your solved model now appears as follows:

The *SIMXPO* Worksheet After Solving

The screenshot shows the Microsoft Excel interface with the following data in the SIMXPO worksheet:

Period	Sales	Predicted	Squared Error
1	\$10	10.000	0.000
2	\$14	10.000	16.000
3	\$12	12.601	0.362
4	\$19	12.210	46.100
5	\$14	16.626	6.896
6	\$21	14.918	36.989
7	\$19	18.874	0.016
8	\$26	18.956	49.621
Sum =			155.984
Alpha	0.650		
Lower bound	>=		
Upper bound	<=		

The Excel interface also shows the ribbon with 'File', 'Home', 'Insert', 'Page Layout', 'Formulas', 'Data', 'Review', 'View', 'Developer', 'Team', and 'What's Best!'. The status bar at the bottom indicates 'Ready' and '100%' zoom.



Following is another sample file called *SMOOTH*, which uses the same principles to analyze a much larger set of data covering 2 years:

The *SMOOTH* Worksheet Before Solving

The screenshot shows the Microsoft Excel interface with the 'SMOOTH' worksheet open. The title bar reads 'SMOOTH.xlsx - Microsoft Excel'. The ribbon includes 'File', 'Home', 'Insert', 'Page Layout', 'Formulas', 'Data', 'Review', 'View', 'Developer', 'Team', and 'What's Best!'. The active cell is A1, containing the text 'Exponential Smoothing Model'. The formula bar shows 'Exponential Smoothing Model'. The worksheet contains the following data:

		Sales	Predicted		Squared Error	Sum Squared Error	
1			\$1.10			408.49	
2	1	\$1.10	\$1.10	Not =	0.18		Upper & Lower Bounds
3	2	\$1.52	\$0.00	=	3.10		Alpha 0.00 Not >= <=
4	3	\$1.76	\$0.00	=	3.46		
5	4	\$1.86	\$0.00	=	2.46		
6	5	\$1.57	\$0.00	=	2.69		
7	6	\$1.64	\$0.00	=	2.69		
8	7	\$1.64	\$0.00	=	2.69		
9	8	\$2.12	\$0.00	=	4.49		
10	9	\$1.39	\$0.00	=	1.93		
11	10	\$2.29	\$0.00	=	5.24		
12	11	\$1.67	\$0.00	=	2.79		
13	12	\$2.42	\$0.00	=	5.86		
14	13	\$1.84	\$0.00	=	3.39		
15	14	\$1.65	\$0.00	=	2.72		
16	15	\$1.81	\$0.00	=	3.28		
17	16	\$2.13	\$0.00	=	4.54		
18	17	\$2.20	\$0.00	=	4.84		
19	18	\$2.31	\$0.00	=	5.34		
20	19	\$2.10	\$0.00	=	4.41		

The status bar at the bottom shows 'Ready', a grid icon, a zoom level of 100%, and a scroll bar.

The solution is shown below.

The *SMOOTH* Worksheet After Solving

The screenshot shows the Microsoft Excel interface with the 'SMOOTH.xlsx' file open. The active worksheet is 'SMOOTH'. The data is organized as follows:

	A	B	C	D	E	F	G	H	I	J	K	L
1	Exponential Smoothing Model						Sum					
2						Squared	Squared					
3		Sales	Predicted			Error	Error					
4	1	\$1.10	\$1.10	=	\$1.34	0.18	5.81	Upper & Lower				
5	2	\$1.52	\$1.34	=	\$1.58	0.18	Bounds					
6	3	\$1.76	\$1.58	=	\$1.74	0.08	Alpha	0.56	>=	<=		
7	4	\$1.86	\$1.74	=	\$1.64	0.03						
8	5	\$1.57	\$1.64	=	\$1.64	0.00						
9	6	\$1.64	\$1.64	=	\$1.64	0.00						
10	7	\$1.64	\$1.64	=	\$1.64	0.00						
11	8	\$2.12	\$1.91	=	\$1.91	0.23						
12	9	\$1.39	\$1.62	=	\$1.62	0.27						
13	10	\$2.29	\$2.00	=	\$2.00	0.45						
14	11	\$1.67	\$1.81	=	\$1.81	0.11						
15	12	\$2.42	\$2.15	=	\$2.15	0.37						
16	13	\$1.84	\$1.98	=	\$1.98	0.10						
17	14	\$1.65	\$1.79	=	\$1.79	0.11						
18	15	\$1.81	\$1.80	=	\$1.80	0.00						
19	16	\$2.13	\$1.99	=	\$1.99	0.11						
20	17	\$2.20	\$2.11	=	\$2.11	0.05						
21	18	\$2.31	\$2.22	=	\$2.22	0.04						
22	19	\$2.10	\$2.15	=	\$2.15	0.01						

# Linearization Option: Construction Cost Estimation

File name: LINEARZ.XLSX

TYPE: NONLINEAR/LINEAR OPTIMIZATION

## Application Profile

This example demonstrates how one might develop a model for estimating construction costs, as well as performance gains resulting from What'sBest!'s exclusive linearization option. Note, we classify this model as both nonlinear and linear. As you will see, the model, as formulated, is nonlinear. However, after invoking the linearization option in What'sBest!, the solver automatically converts this nonlinear model to an equivalent linear model.

## The Problem in Words

You are a contractor specializing in home construction. You have the opportunity to bid on a job that involves building a number of homes in a new housing development. In order to place an intelligent bid, you need to calculate your expected cost on a per home basis. Based on past experience, you know the following three factors primarily determine the construction cost of a house: total square footage, number of bedrooms, and number of baths.

You believe there is a linear relationship between these three factors and total cost. Specifically, you have come up with the following equation:

$$\text{Total Cost} = \beta_1 + (\beta_2 * \text{Sq. Feet}) + (\beta_3 * \text{Bedrooms}) + (\beta_4 * \text{Bathrooms}) \quad (i)$$

You pull up the following historical data from projects your company has completed in the past:

Sq. Feet	Beds	Baths	Cost(\$000)
1500	1	1	78.5
1600	1	1	105.8
2200	2	1	149.1
2600	3	2	173.8
3000	3	2	224.4
3500	5	2	267.0
4000	4	4	302.7
5200	2	3	302.0
8200	4	4	438.7
8700	6	4	490.4

## Objective of Optimization

You will use your historical data to estimate values for the beta coefficients ( $\beta_1$ ,  $\beta_2$ ,  $\beta_3$ , and  $\beta_4$ ) in formula (i). You want your estimation function to avoid the case where it might be a poor predictor on one type of home. Thus, you have decided you want your model's objective to minimize the maximum error in your cost estimations. Note, that this process of fitting a linear function to a set of data points is referred to as *linear regression*.

## The Worksheet

A picture of the worksheet used to solve this problem is listed below. You can find it in your sample models directory under the name *LINEARZ* sample file:

The *LINEARZ* Worksheet Before Optimization

		Sq. Feet	Beds	Baths	Actual Cost	Pred Cost	Error
4		1500	1	1	78.5	0.0	78.5
5		1600	1	1	105.8	0.0	105.8
6		2200	2	1	149.1	0.0	149.1
7		2600	3	2	173.8	0.0	173.8
8		3000	3	2	224.4	0.0	224.4
9		3500	5	2	267.0	0.0	267.0
10		4000	4	4	302.7	0.0	302.7
11		5200	2	3	302.0	0.0	302.0
12		8200	4	4	438.7	0.0	438.7
13		8700	6	4	490.4	0.0	490.4
15	<b>Coefficients:</b>				<b>Max Error:</b>		
16	0.0000	0.0000	0.0000	0.0000	490.4		

### A. Determine Adjustable Cells

The adjustable cells in the model are the beta coefficients. We need *What'sBest!* to pick the values for the coefficients that minimize the maximum prediction error. There are four beta *Coefficients*, so we added four adjustable cells to represent them in the range B16:E16. B16 is the “intercept” coefficient, C16 is the coefficient for square feet, D16 is the coefficient on the number of bedrooms, and, finally, E16 is the coefficient on the number of baths.

### B. Define Best

We want to minimize the *Max Error*, which is computed in cell H16 with the formula  $MAX(H4:H13)$ . The range H4:H13 contains the amount of *Error* in our forecast for each of the historical cost observations. For example, cell H4 contains the formula  $ABS(F4-G4)$ . In words, this is the absolute value of the difference of the *Actual Cost* (F4) minus the *Predicted Cost* (G4). This gives us the amount of forecast error on the first observation. Cell H16 simply takes the maximum of all these error terms. This, of course, is our objective, and we tell *What'sBest!* to minimize it.

### C. Specify Constraints

This is an unusual model in that it doesn't make use of any limited resources, so no constraints are required.

You are almost ready to solve the model, but first you will need to set a couple of options on the *General Options* tab. First, you will need to set the *Linearization Degree* to *Maximum* to have the *What'sBest!* linearizer automatically convert this otherwise nonlinear model to linearity. Next you will need to reduce the *Big M Coefficient* from its default value of 100,000 to 1,000. Linearized models are very sensitive to this parameter. If *Big M* is too large, you can end up with poorly scaled models. On the other hand, setting this parameter too low will result in infeasible models. For this particular model a setting of 1,000 works well.

After solving, you'll see the following result.

The *LINEARZ* Worksheet After Optimization

	Sq. Feet	Beds	Baths	Actual Cost	Pred Cost	Error
4	1500	1	1	78.5	123.4	44.9
5	1600	1	1	105.8	128.8	23.0
6	2200	2	1	149.1	161.0	11.9
7	2600	3	2	173.8	182.5	8.7
8	3000	3	2	224.4	204.0	20.4
9	3500	5	2	267.0	230.9	36.1
10	4000	4	4	302.7	257.8	44.9
11	5200	2	3	302.0	322.3	20.3
12	8200	4	4	438.7	483.6	44.9
13	8700	6	4	490.4	510.5	20.1
15	<b>Coefficients:</b>			<b>Max Error:</b>		
16	42.7567	0.0538	0.0000	0.0000	44.9	

Thus, our optimal solution minimizes the maximum error at 17.8 using the following formula:

$$\text{Total Cost} = 5.6896 + (0.0373 * \text{Sq. Feet}) + (19.5877 * \text{Beds}) + (15.0613 * \text{Baths})$$

### Linearization

Note that as formulated, this model is nonlinear. This is the result of the *ABS()* and *MAX()* functions used in computing the error terms and the objective value, respectively. Both *ABS()* and *MAX()* can create problems for the nonlinear solver in that they aren't continuously differentiable. Both functions have "kinks" in their graphs at various points that the nonlinear solver is unable to "see" around. With a fair amount of effort, one could linearize this model by adding a number of additional variables and constraints. However, the linearization option in *What'sBest!* can do this for you automatically.

For illustration, we ran this model twice—once with linearization off and once with it on—using the two *Linearization Degree* settings of *None* and *Maximum*. The adjustable cells were reset to 0 for each run. Here are some comparative results:

<b>Linearization:</b>	<b>Off</b>	<b>On</b>
Adjustables	4	4
Constraints	0	61
Integers (Bin)	0	20
Variables	25	76
Nonlinears	20	0
Solution Time (sec)	1	<1

As you can see, the model is considerably larger with linearization enabled, because it has internally increased the number of variables (from 25 to 76), integers (from 0 to 20), and constraints (from 0 to 61). The crucial observation, however, is that the number of nonlinears goes from 20 to 0. Thus, the linearization completely removes all the nonlinearities from the model. This allows *What'sBest!* to invoke its faster and more accurate linear solver, which reduces total solution time down to less than 1 second.

In conclusion, if your model has nonlinearities that can all be handled by the *What'sBest!* linearizer, solution times can be reduced dramatically by engaging the linearization option. For more information on setting the linearization options, see *Selecting Options*. For more information on the linearization process, see *Overview of Mathematical Modeling*. For a list of the functions that can be linearized automatically by *What'sBest!*, see *Functions and Operators*.

---

# Stratified Sampling

File name: SAMPLEWB.XLSX

TYPE: NONLINEAR OPTIMIZATION

## Application Profile

This model is useful wherever you need to determine an optimal statistical sampling strategy. Opinion polling and market research are two areas in which models similar to this one might be used.

## The Problem in Words

In your work in market research for an appliance manufacturer, you must determine the consumer's trend toward purchasing your product. You need to determine two population means using the smallest (least costly) sample likely to give reliable results. To reduce error, you break up the population by income groups. You're asking two questions:

- ◆ How much do you plan to spend on major appliances next year?
- ◆ On a scale of 1 to 100, how likely are you to buy our brand?

## Background

The population data looks like this:

Stratum	Income Group	Population	Variance in Response	
			Question 1	Question 2
1	\$50,001 +	400,000	5	1
2	35,001 - 50,000	300,000	5	2
3	22,501 - 35,000	200,000	5	4
4	under 22,500	100,000	5	8

You have determined your tolerable upper limits of variance for both sample means, and you know the variance by question for each group.

## Objective of Optimization

The objective is to determine the best sample size for each stratum while minimizing the cost to obtain the sample.

## The Worksheet

Let's look at the sample file called *SAMPLEWB*:

The *SAMPLEWB* Worksheet *Before Solving*

	1	2	3	4
Sample Size	1.00	1.00	1.00	1.00
Lower Bound	>=	>=	>=	>=
Upper Bound	<=	<=	<=	<=
Population	400000	300000	200000	100000
Cost	\$1.00	\$1.00	\$1.00	\$1.00
Weight	40.0%	30.0%	20.0%	10.0%
Stratum Variance:				
Question 1	5	5	5	5
Question 2	1	2	4	8
Fixed Cost	\$1.00			
Total Cost	\$5.00			
			Maximum Variance	
Question 1	7.4999	Not <=	0.043	
Question 2	1.799915	Not <=	0.014	

### A. Determine Adjustable Cells

The adjustable cells are B5:E5, the *Sample Sizes* for each stratum.

### B. Define Best

The best cell is the minimized cost of sampling in cell B16. The formula here adds a *Fixed Cost* (a nominal \$1.00 in this example) to the sum of sample sizes times the cost per unit sampled.

### C. Specify Constraints

There are four types of constraints in the model.

In B6:E6, a *Lower Bound* of .001 is placed on the sample sizes. This ensures that optimizer errors caused by division by zero will not occur.

In B7:E7, the sample size is required to be no larger than the population from which it is taken.

In C18 and C19, the variances on the two measured features are bounded on the upper end, so as to force reliable estimates. The variances are computed in B18 and B19. For instance, the variance computed for *Question 1* in B18 is found by means of the formula:



$$\begin{aligned}
 & (\$B\$10^2 * B12^2) / \$B\$5 + (\$C\$10^2 * C12^2) / \$C\$5 + (\$D\$10^2 * D12^2) / \$D\$5 + \\
 & (\$E\$10^2 * E12^2) / \$E\$5 - (\$B\$10 * B12^2 / \$B\$8 + \$C\$10 * C12^2 / \$C\$8 + \\
 & \$D\$10 * D12^2 / \$D\$8 + \$E\$10 * E12^2 / \$E\$8)
 \end{aligned}$$

That is, for each *Stratum*, its *Weight*<sup>2</sup> times *Variance*<sup>2</sup> is divided by its sample size. The resulting figures are summed. For each stratum, from that result is subtracted the *Weight* times *Variance*<sup>2</sup> divided by *Population* size. This formulation is from *Sampling Techniques*, W.G. Cochran, 2nd Ed., Wiley, New York, 1963, to which interested readers may refer.

Now, you are ready to solve the model. After solving, the *WB! Status* worksheet will open in order to show you the *Nonlinearity* present warning. This warning can be shut off from the *General Options* dialog box. Your solved model now appears as follows:

The *SAMPLEWB* Worksheet After Solving

	1	2	3	4
Sample Size	205.61	164.44	133.46	101.23
Lower Bound	>=	>=	>=	>=
Upper Bound	<=	<=	<=	<=
Population	400000	300000	200000	100000
Cost	\$1.00	\$1.00	\$1.00	\$1.00
Weight	40.0%	30.0%	20.0%	10.0%
Stratum Variance:				
Question 1	5	5	5	5
Question 2	1	2	4	8
Fixed Cost	\$1.00			
Total Cost	\$605.74			
			Maximum Variance	
Question 1	0.043	=<=	0.043	
Question 2	0.014	=<=	0.014	

The solution tells you the minimal sample sizes that yield reliable results within the tolerances you've set. This data could be used to calculate the probable success of a marketing plan or in forecasting demand for next year's production.

# Car Pricing

File name: PRICING.XLSX

TYPE: NONLINEAR OPTIMIZATION

---

## The Problem in Words

You manufacture three automobile models, each with its own price structure and miles-per-gallon rating, at your five plants.

An increase in sales of any one model results in a small decrease in sales of the two others. The models compete for production capacity in your five plants. Also, the federal government has imposed an lower limit on the average “fleet mileage” of your entire production, which makes sales of low-mileage cars more desirable.

You need to set the prices of the three models of automobiles, so profit is maximized at the five plants, while staying within the federal fleet gas mileage requirement of 24 miles per gallon.

## Background

Your known values are the cost of manufacturing each model at each plant, the miles per gallon for each model, and the annual production capacity at each plant.

You also know price-quantity relationships among the models, called *demand curves* by economists. These demands are dependent upon the price of each car related to the prices of the other cars.

## Objective of Optimization

The objective is to determine the best price for each car to maximize profit while conforming to all regulations and constraints.

---

## The Worksheet

Let's look at the sample file called *PRICING*.

### The *PRICING* Worksheet Before Solving

	A	B	C	D	E	F	G	H	I
1	CAR PRICING MODEL								
2				Plant:				Miles per	
3	Cost/Unit:	D	E	F	G	H	Gallon		
4	Rangler	\$7.0	\$8.0				29.00		
5	Mercurial		\$12.0	\$10.5	\$12.5		23.00		
6	Cadimac				\$17.0	\$15.5	19.00		
7	Production:								
8	Rangler	1.00	1.00						
9	Mercurial		1.00	1.00	1.00				
10	Cadimac				1.00	1.00			
11	Capacity/year	500.00	100.00	200.00	50.00	50.00			
12	Constraint	<=	<=	<=	<=	<=			
14		Price	Produced	Constraint	Demand		Total		
15	Rangler	\$1.00	2.00	<=	1504.00		Profit (\$75.50)		
16	Mercurial	\$1.00	3.00	<=	486.00				
17	Cadimac	\$1.00	2.00	<=	178.00				
18			7.00	>=	0.00				
20		Produced	Requirement						
21	Miles/Gallon	23.57143	Not >=			24			

### A. Determine Adjustable Cells

The adjustable cells in the model are the quantity of each automobile to produce at each plant (B8:F10) and the *Price* (in thousands) to charge for each unit (B15:B17).

### B. Define Best

The best cell is the maximized *Total Profit* in G16. The formula there is:

$$\text{SUMPRODUCT}(B15:B17,C15:C17)-(B4*B8+C4*C8+C5*C9+D5*D9+E5*E9+E6*E10+F6*F10)$$

This is profit minus production costs.

### C. Specify Constraints

The constraints in the model enforce the three requirements.

In B12:F12, yearly production at each plant (the sum of car models produced at a given plant) is required to be no greater-than that plant's capacity. For instance, the constraint for *Plant D* (B12), is  $WB(\text{SUM}(B8:B10), "<=", B11)$ .

In D15:D17, the total quantity *Produced* of each auto (C15:C17) is forced to be no greater-than the quantity required according to that model's demand curve formula (E15:E17). The estimates for these demand curves have been supplied by your econometrics department. For example, the demand curve formula for the *Mercurial* (E16) is:

$$495-13*B16+3*B15+B17$$

Note that the demand curves for the three makes of auto are interdependent (the sales of one influence demand for the other two).

Finally, cell C20 contains the constraint  $WB(B20,">=",D20)$ , which forces the average *Miles/Gallon* across the produced quantity of all three makes (B20) to be at least 24. The formula in B20 is:

$$SUMPRODUCT(G4:G6,C15:C17)/SUM(C15:C17)$$

---

**Note:** The federal guideline is expressed in miles per gallon. The constraint could more properly be expressed as *gallons per mile*: as if each car sold were driven one mile, a measure taken of total gallons used, and the total cars sold divided by total gallons used. This is because using miles per gallon assumes each car running until the fuel tank is empty. Obviously, the higher-MPG car would go further on a tank of fuel, skewing the overall production in its favor.

---

Now, you are ready to solve the model. After solving, the *WB! Status* worksheet will open in order to show you the *Nonlinearity present* warning. (This warning can be shut off from the *General Options* dialog box.) Your solved model appears as follows.

The *PRICING* Worksheet After Solving

	A	B	C	D	E	F	G	H	I
1	CAR PRICING MODEL								
2	Plant:								
3	Cost/Unit:	D	E	F	G	H	Miles per		
4	Rangler	\$7.0	\$8.0					Gallon	
5	Mercurial		\$12.0	\$10.5	\$12.5			29.00	
6	Cadimac				\$17.0	\$15.5		23.00	
7	Production:							19.00	
8	Rangler	480.73	0.00						
9	Mercurial		0.00	183.59	0.00				
10	Cadimac				26.23	50.00			
11	Capacity/year	500.00	100.00	200.00	50.00	50.00			
12	Constraint	<=	<=	<=	<=	=<=			
14		Price	Produced	Constraint	Demand				
15	Rangler	\$12.39	480.73	=<=	480.73		Total		
16	Mercurial	\$29.96	183.59	=<=	183.59		Profit	\$8,063.44	
17	Cadimac	\$40.92	76.23	=<=	76.23				
18			740.55	>=	0.00				
20		Produced		Requirement					
21	Miles/Gallon	26.48315	>=	24					

# Media Buying

File name: MEDIA.XLSX

TYPE: LINEAR OPTIMIZATION

---

## Application Profile

Media selection (or buying) is the problem of finding the best way to deliver the desired number of advertising exposures to the target audience by determining the most efficient combination of advertising media purchases. Even for small media budgets, there can be literally thousands of possible media schedules from which to choose. The task is to select from this set an effective schedule to become the media plan.

What's*Best!* provides a natural format for analyzing a media selection problem. You can use it to find the media mix that will maximize the number of effective exposures subject to a set of constraints: the ad budget, minimum and maximum media availabilities, minimum desired exposure rates, etc.

A great advantage of What's*Best!* is that new plans can be generated quickly to show the significance of changes made in problem specifications.

## The Problem in Words

You're a media buyer for an advertising agency. You need to minimize the cost while satisfying minimum exposure needs.

## Background

There are six target markets, *Groups* 1 through 6, and each requires a specified number of media exposures. There are five different media sources: the *Times*, *Mirror*, *Tribune*, *Herald*, and *Post*, over which the advertising dollars are to be allocated. Each of the media sources offers various combinations of exposures per dollar spent for each of the different target groups.

## Objective of Optimization

The objective is to determine how much of each of the media sources should be purchased to meet the exposure requirements at lowest cost.

---

## The Worksheet

Let's open the *MEDIA* sample file and look at its structure and formulas.

### The *MEDIA* Worksheet Before Solving

OPTIMAL MEDIA BUYING							
Exposure per Dollar by Market and Medium (\$ Thousands)							
Media	Group1	Group2	Group3	Group4	Group5	Group6	Dollars Allocated
Times	0	10	5	50	5	0	0.00
Mirror	0	10	30	5	10	0	0.00
Tribune	20	0	0	0	0	5	0.00
Herald	10	0	0	0	0	5	0.00
Post	0	5	5	10	10	5	0.00
Exposures	0	0	0	0	0	0	
Met?	Not >=	Not >=	Not >=	Not >=	Not >=	Not >=	TOTAL COST:
Requirement:	25.0	40.0	60.0	120.0	40.0	11.0	\$0.00

The exposures per dollar are listed for each media source and each media source in B9:G13. Notice that each media source reaches different combinations of target groups per dollar spent. Cells B15:G15 show the minimum required exposures for each of the target groups.

#### A. Determine Adjustable Cells

The adjustable cells in this model are the *Dollars Allocated* to each media source (cells H9 through H13).

#### B. Define Best

The best solution is the one that meets *Requirements* at the lowest cost. The *Total Cost* cell (H17) shows that every change in *Dollars Allocated* will have a direct bearing on cost.

#### C. Specify Constraints

The constraints are that the minimum *Requirements* be met. The *Exposures* formulas in B17:G17 are the sumproduct of the number of exposures per dollar for a media source and the amount in dollars being allocated to that source. The formulas in the row *Met?* (B16:G16) force these amounts to be greater-than-or-equal-to the required exposures for each targeted group (B15:G15).

### “What If?” vs. What’sBest!

Work on a conventional “What If?” spreadsheet solution to this problem by adjusting the *Dollars Allocated* shown in cells H9:H13. You’ve reached a viable solution when cells B16:G16 return “>=” or “>=”. Judge any solution that meets all the exposure requirements by minimizing *Total Cost* (H18). When you arrive at a reasonable answer, jot down your total cost figure.

Now, let’s solve the model with What’sBest!

The *MEDIA* Worksheet After Solving

OPTIMAL MEDIA BUYING							
Exposure per Dollar by Market and Medium (\$ Thousands)							
	Target Markets						Dollars
	Group1	Group2	Group3	Group4	Group5	Group6	Allocated
Media							
9 Times	0	10	5	50	5	0	1.93
10 Mirror	0	10	30	5	10	0	1.41
11 Tribune	20	0	0	0	0	5	1.25
12 Herald	10	0	0	0	0	5	0.00
13 Post	0	5	5	10	10	5	1.63
15 Exposures	25	41.538	60	120	40	14.382	
16 Met?	>=	>=	>=	>=	>=	>=	TOTAL COST:
17 Requirement:	25.0	40.0	60.0	120.0	40.0	11.0	\$6.22

As you can see, the What’sBest! solution has a total cost of \$6,220. It results in surplus exposures in only two target markets, *Group 2* and *Group 6*. It proposes no media purchases from the *Herald*, which, offering only 15 total exposures per dollar, is not a bargain.

### D. Dual Values

Dual values can be applied to cells H9:H13, giving the cost penalty associated with using a media source when the optimizer determines zero dollars should be allocated for that source. In this example, the optimizer determines that zero dollars should be allocated for the *Herald*. By using the *Advanced|Dual* command, you would find that the total cost, \$6,220, will be increased by \$500 for every \$1,000 spent on the *Herald*. Dual values for cells B16:G16 would give the dollar cost of requiring a thousand more exposures.



---

# Multi-Period Inventory Management

File name: INVENT.XLSX

TYPE: LINEAR OPTIMIZATION

---

## Application Profile

What if your product is made from materials that are in limited supply and require special or expensive storage facilities? In such a situation, you have to keep purchasing and inventory costs down, but still keep enough stock to meet demand. If you use perishable resources or materials subject to supply limitations, you may encounter problems like this one.

## The Problem in Words

Your production demands vary over thirteen time periods. Raw materials, available at varying costs from three different suppliers, must occasionally be held in sufficient quantity from time period to time period to meet production needs. A holding cost associated with inventory held over further complicates the picture. How can you determine how much inventory to hold and which supplier to use while minimizing total cost and meeting your customers' demand for the product?

## Background

You know the unit demand for each of the thirteen time periods. For instance, the demand for *Time Period 1* must be met by using some combination of sources 1, 2, and 3. The ending inventory is equal-to starting inventory plus the sum of amounts purchased from each source less the unit demand.

You must not only satisfy the demand for each period, but also minimize the amount of inventory held over. Obviously, it's in your interest to purchase as much as possible from your least expensive source, *Source 1*. However, demand in some periods exceeds *Source 1*'s capacity.

## Objective of Optimization

The objective in the *Inventory* model is to minimize the total cost and determine how much material to buy from each source in each time period to meet customer demand at lowest purchase and holding costs.

---

## The Worksheet

Let's look at the *INVENT* worksheet and note that *Source 1* is obviously the best bargain (D21). However, as demand rises from period to period (B6:B18), *Source 1*, with a capacity of 180, won't suffice to meet demand.

The *INVENT* Worksheet Before Solving

Time Period	Demand	Met?	Purchase From Source #	Ending Inventory	Cost Per Period
0			1 2 3	0	
1	100	Not <=	0 0 0	-100	(\$200)
2	180	Not <=	0 0 0	-280	(\$560)
3	220	Not <=	0 0 0	-500	(\$1,000)
4	150	Not <=	0 0 0	-650	(\$1,300)
5	100	Not <=	0 0 0	-750	(\$1,500)
6	200	Not <=	0 0 0	-950	(\$1,900)
7	250	Not <=	0 0 0	-1200	(\$2,400)
8	300	Not <=	0 0 0	-1500	(\$3,000)
9	260	Not <=	0 0 0	-1760	(\$3,520)
10	250	Not <=	0 0 0	-2010	(\$4,020)
11	240	Not <=	0 0 0	-2250	(\$4,500)
12	210	Not <=	0 0 0	-2460	(\$4,920)
13	140	Not <=	0 0 0	-2600	(\$5,200)

Time Period	1	2	3
1	<=	<=	<=
2	<=	<=	<=
3	<=	<=	<=
4	<=	<=	<=

### A. Determine Adjustable Cells

The adjustable cells (D6:F18) are the amounts purchased for each time period from each of the three supply sources.

### B. Define Best

The best solution to this inventory problem consists of the combination of purchases from each source in each time period that results in the minimum *Total Cost* (H21). The formula in this cell, *SUM*(H6:H18), is the sum of period costs. Each period cost is composed of the sum of the purchasing and inventory holding costs for that period.

### C. Specify Constraints

The constraints are that there must be sufficient supply for each time period to satisfy your demand and the capacity of the three suppliers must not be exceeded.

The first constraints are found in C6:C18. Look at the formula in C6 ( $WB(B6, "<=", G5 + SUM(D6:F6))$ ). The amount held over from the period before (G5) is added to the sum of purchases from the three sources, and required to be greater-than-or-equal-to total demand for period 1 (B6).

The second group of constraints (D27:F39) is that supply sources not be used beyond their capacity, is in cells D27:F39. In cell D27, for instance, is the formula  $WB(D6, "<=", $D$20)$ . D6, the amount purchased from *Source 1* in *Period 1*, is required to be less-than-or-equal-to D20, the supply capacity per period.

Now, let's solve the model.

The *Inventory Worksheet After Solving*

Time Period	Demand	Met?	Purchase From Source #	1	2	3	Ending Inventory	Cost Per Period
0							0	
1	100	<=	140	0	0	0	40	\$14,080
2	180	<=	180	0	0	0	40	\$18,080
3	220	=<=	180	0	0	0	0	\$18,000
4	150	<=	180	0	0	0	30	\$18,060
5	100	<=	180	0	0	0	110	\$18,220
6	200	<=	180	36	0	0	126	\$22,104
7	250	<=	180	36	0	0	92	\$22,036
8	300	<=	180	36	0	0	8	\$21,868
9	260	=<=	180	36	36	0	0	\$25,920
10	250	=<=	180	36	34	0	0	\$25,694
11	240	=<=	180	36	24	0	0	\$24,564
12	210	=<=	180	30	0	0	0	\$21,210
13	140	=<=	140	0	0	0	0	\$14,000

Time Period	1	2	3	4
1	<=	<=	<=	
2	=<=	<=	<=	
3	=<=	<=	<=	
4	=<=	<=	<=	

What'sBest! has arrived at a minimized *Total Cost* of \$263,836 (H21).

This simple model is intended to demonstrate the basic principles in modeling inventory. Add fixed ordering and shipping costs for each source, etc., for a model more reflective of the real world.

# Product Mix

File name: PRODMIX.XLSX,  
PMIXMAC.XLSM

---

TYPE: LINEAR OPTIMIZATION

## Application Profile

In product mix problems, the objective is to find the most profitable allocation of a set of limited resources over a set of desired products or activities. Virtually every manufacturer faces this situation in some form or another.

This example involves the conversion of raw materials into manufactured goods. An agricultural example might involve the use of land, seed, water, labor, and fertilizer so as to maximize farm output. Product mix problems often serve as the “building blocks” for more complex applications.

## The Problem in Words

You are a manufacturer producing six products from six materials with each product requiring a different combination and amount of raw materials.

## Background

You know the profit per unit of each product and the quantity of each raw material required for a single unit of each product. For instance, each unit of product 2 contributes \$45 to profit and uses 4 units of steel, 5 of wood, 3 of plastic, etc. in its manufacture.

## Objective of Optimization

The objective of optimization is to maximize the profits that can be realized from manufacturing products using only the current inventory of raw materials.

---

## The Worksheet

Let's look at the *PRODMIX* sample file.

### The *PRODMIX* Worksheet Before Optimization

The screenshot shows the following data in the Excel worksheet:

Product	1	2	3	4	5	6
Profit/Unit	\$30	\$45	\$24	\$26	\$24	\$30
Quantity Produced	0	0	0	0	0	0

	Product Resource Requirements							Total Usage	Start. Inv.
Steel	1	4	0	4	2	0	0	800	
Wood	4	5	3	0	1	0	0	1160	
Plastic	0	3	8	0	1	0	0	1780	
Rubber	2	0	1	2	1	5	0	1050	
Glass	2	4	2	2	2	4	0	1360	
Paint	1	4	1	4	3	4	0	1240	

#### A. Determine Adjustable Cells

The adjustable cells in this model (B8:G8) contain the *Quantity Produced* for each product.

#### B. Define Best

The best solution is the one that results in the maximum *Total Profit* (A3). Take a moment to examine the formula in this cell:

$$\text{SUMPRODUCT}(B6:G6, B8:G8)$$

That is interpreted as *Profit/Unit of Product 1 \* Quantity Produced of Product 1 + Profit/Unit of Product 2 \* Quantity Produced of Product 2* and so on. You want to find a combination of values (B8:G8) that will yield the highest *Total Profit* (A3).

**Note:** The *SUMPRODUCT* method of expression eliminates the need for lengthy formulas, while simplifying later addition of other products. Inserting rows (not appending) within the ranges allows you to enlarge them without rewriting the Total Cost formula. In writing small models, you may find it easier to write such formulas without *SUMPRODUCT*. In large models, or ones you intend to enlarge, it's probably best to use *SUMPRODUCT*.

### C. Specify Constraints

The constraints in this problem (I14:I19) must reflect the requirement that total usage of raw materials remain less-than-or-equal-to the quantities of raw materials in stock. This necessitates a separate constraint for each of the six raw materials. For instance, the constraint in I14, *WB* (H14, "<=", J14) requires that the *Total Usage* (H14) be less-than-or-equal-to the *Starting Inventory* (J14).

*Total Usage* (H14:H19) is determined based on the *Product Resource Requirements* defined within the model (B14:G19). For instance, the formula in H14 for *Total Steel Usage* is  $SUMPRODUCT(B14:G14, B\$8:G\$8)$ . That is interpreted as the *Steel* requirement per unit of *Product 1* \* *Quantity Produced of Product 1* + *Steel* requirement per unit of *Product 2* \* *Quantity Produced of Product 2* and so on.

#### “What if?” vs. What’sBest!

Spend a few minutes working with the model to try to maximize *Total Profit* (A3) by inserting and adjusting the *Quantities Produced* (B8:G8) for each product. As you go through these “What If?” projections, be sure to use no more of any raw material than you currently have in your *Starting Inventory*.

As you near exhaustion of any raw material, look at the *Product Resource Requirements* table (B14:G19) for products that require relatively little of that material. Also, remember to use *Profit/Unit* (B6:G6) as a guide to the effect of incremental production of each product. Judge each of your hypothetical solutions by the *Total Profit* (A3) generated. Once you arrive at a reasonable solution, jot down its total profit.

---

Now that you've experimented on your own, you're ready to solve the model.

The *PRODMIX* Worksheet *After* Optimization

		PRODUCT MIX							
TOTAL PROFIT:								\$15,020.00	
Product		1	2	3	4	5	6		
Profit/Unit		\$30	\$45	\$24	\$26	\$24	\$30		
Quantity Produced		120	0	220	160	20	50		
		Product Resource Requirements						Total Usage	Start. Inv.
Steel		1	4	0	4	2	0	800	=<= 800
Wood		4	5	3	0	1	0	1160	=<= 1160
Plastic		0	3	8	0	1	0	1780	=<= 1780
Rubber		2	0	1	2	1	5	1050	=<= 1050
Glass		2	4	2	2	2	4	1240	<= 1360
Paint		1	4	1	4	3	4	1240	=<= 1240

The best possible solution to this problem is a total profit of \$15,020. Note how effectively *What'sBest!* used the available raw materials — and how quickly this optimal solution was calculated. Note also how many of each product *What'sBest!* tells you to produce and that the solution manufactures none of the product with the highest profit contribution! This nonintuitive result, which you'd have difficulty finding through “what-if”, is a good indication of the power of *What'sBest!*.

# The Building Block Method

File name: BLOCK.XLSX

TYPE: LINEAR OPTIMIZATION

## Application Profile

This example uses the full power of your spreadsheet software to develop larger applications using smaller ones as building blocks. In this way, comprehensive models can be created that can simultaneously cover many different aspects of a business situation.

## The Problem in Words

You run three plants. Each plant is capable of producing six products from six raw materials. You also operate two steel mills that can ship steel as a raw material to any of your plants. You want to know the amount of steel each mill should ship to each plant and the number of products each plant should produce to maximize your total profit.

## Background

The *PRODMIX* (shown earlier) and *SHIPPING* (shown later) worksheets are combined in the *BLOCK* problem, which involves maximizing the profit from several manufacturing plants while minimizing the cost of shipping raw materials from multiple sites. The cost of shipping one unit of steel from each of the mills to each of the plants is shown in the table below:

Shipping Costs Per Unit of Steel			
	From:	Steel	Steel
To:		<u>Mill 1</u>	<u>Mill 2</u>
<b>Plant A</b>		\$2	\$5
<b>Plant B</b>		\$3	\$4
<b>Plant C</b>		\$5	\$6

*Mill 1* has a maximum total capacity of 1200 units and *Mill 2* has a maximum total capacity of 1800 units. Each plant has an 800 unit minimum requirement of steel for the period that has been specified by each plant manager. The actual starting inventory of steel at each plant is determined by the total number of units shipped to that plant from the two steel mills. The starting inventories of the other five raw materials at each plant are listed below:

<u>Resource</u>	<u>Units on Hand</u>
Wood	1160
Plastic	1780
Rubber	1050
Glass	1360
Paint	1240

The profit contribution and product resource requirements for each of the six products are the same as in the *Product Mix* problem.



### Objective of Optimization

The objective of optimization is to maximize total profits. The total profit is the sum of individual plant profits, minus the sum of the shipping costs from the individual steel mills.

### The Worksheet

Let's look at the *BLOCK* sample file.

The *BLOCK* worksheet was built by directly combining the *SHIPPING* and *PRODMIX* worksheets. After combining one copy of the *Shipping Cost Reduction* model with three copies of the *Product Mix* model, we performed only slight modifications to link the four individual problems into one comprehensive model. The model is laid out in a 3D workbook on four separate worksheets—a shipping sheet and three separate manufacturing sheets.

The first worksheet is *Shipping*, built by copying the original *Shipping Cost Reduction* problem into cell A1 of a new workbook. This sheet gives information on the amount of steel that has been shipped from each steel mill to each manufacturing plant, a breakdown of shipping costs, and total costs.

The Shipping Worksheet *Before* Optimization

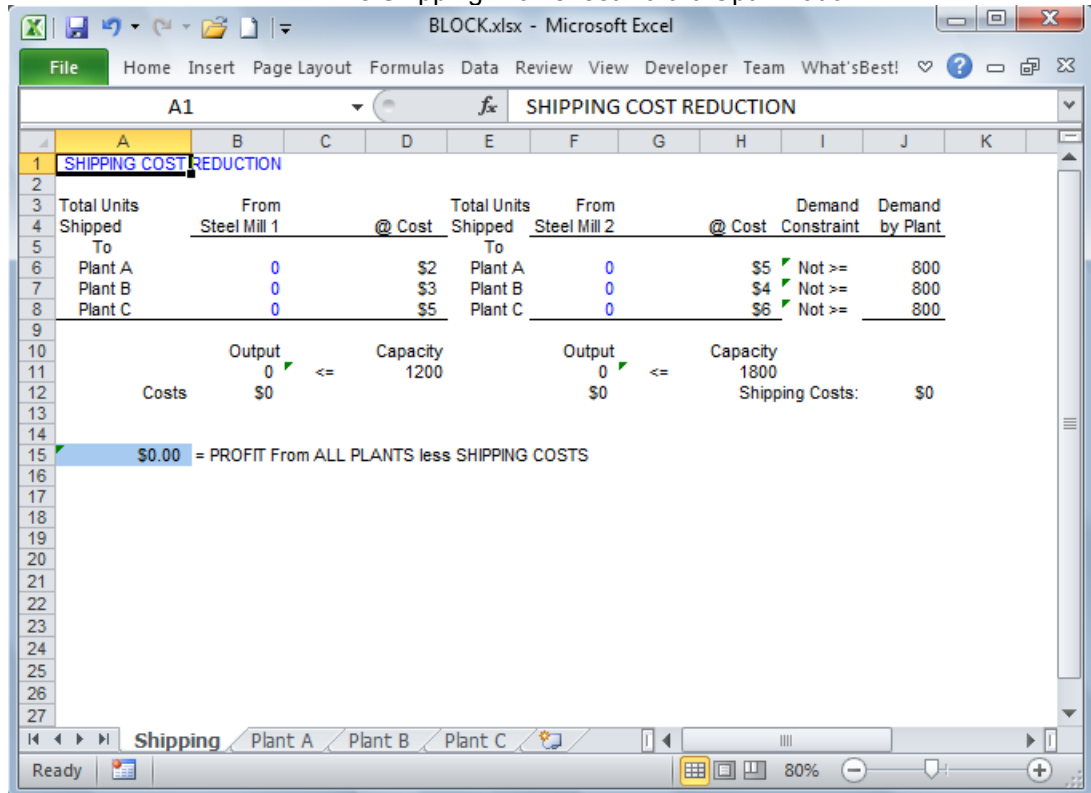

The remaining three worksheets—*Plant A*, *Plant B*, and *Plant C*—are the manufacturing plant screens. They were built by placing the *PRODMIX* model into each of the three tabbed worksheets. Each sheet represents one of the three manufacturing plants.

With the exception of steel, the starting inventories of all the raw materials are the same as in the original problem. The starting inventory of steel for each plant now becomes the amounts shipped from the steel mills to that plant. For example, the formula in cell J13 of *Plant A* worksheet, *Starting Steel Inventory* for steel at *Plant A*, is =Shipping! B6+Shipping! F6. Each plant's sheet tells the quantity of each item produced, inventory total usage amounts, and the profit contribution from that plant.

The *Plant A* Worksheet Before Optimization

	A	B	C	D	E	F	G	H	I	J	K	L
1	Profit at PLANT A											
2	\$0.00											
3	Product:	1	2	3	4	5	6					
4	Profit/Unit:	\$30	\$45	\$24	\$26	\$24	\$30					
5												
6	Quantity Produced:	0	0	0	0	0	0					
7												
8		800 = Minimum Steel Requirement										
9												
10		Product Resource Requirements						Total Usage	Start Inv.			
11												
12												
13	Steel	1	4	0	4	2	0	0	<=>		0	
14	Wood	4	5	3	0	1	0	0	<=>		1160	
15	Plastic	0	3	8	0	1	0	0	<=>		1780	
16	Rubber	2	0	1	2	1	5	0	<=>		1050	
17	Glass	2	4	2	2	2	4	0	<=>		1360	
18	Paint	1	4	1	4	3	4	0	<=>		1240	
19												
20												
21												
22												
23												
24												
25												
26												
27												

With the exception of the best cell, the ABC's in the *BLOCK* model are the same as in its *PRODMIX* and *SHIPPING* components.

### A. Determine Adjustable Cells

The adjustable cells (B6:B8, F6:F8 of the *Shipping* worksheet) are the quantities shipped from each mill to each plant, and the quantities to produce of each product from each plant (B6:G6 of the *Plant A*, *B*, & *C* worksheets).

### B. Define Best

The best solution is the shipping and production decision that maximizes profit at all three plants less all shipping costs. This formula is in cell A15 of the *Shipping* worksheet.



The *Plant A* Worksheet After Optimization

The screenshot shows an Excel spreadsheet titled 'BLOCK.xlsx - Microsoft Excel' with the 'Plant A' worksheet selected. The spreadsheet contains the following data:

	A	B	C	D	E	F	G	H	I	J	K	L	
1	Profit at PLANT A												
2	\$15,020.00												
3	Product:	1	2	3	4	5	6						
4	Profit/Unit:	\$30	\$45	\$24	\$26	\$24	\$30						
5													
6	Quantity Produced:	120	0	220	160	20	50						
7													
8		800 = Minimum Steel Requirement											
9													
10		Product Resource Requirements						Total Usage		Start Inv.			
11													
12													
13	Steel	1	4	0	4	2	0	800	<=<		800		
14	Wood	4	5	3	0	1	0	1160	<=<		1160		
15	Plastic	0	3	8	0	1	0	1780	<=<		1780		
16	Rubber	2	0	1	2	1	5	1050	<=<		1050		
17	Glass	2	4	2	2	2	4	1240	<=<		1360		
18	Paint	1	4	1	4	3	4	1240	<=<		1240		
19													
20													
21													
22													
23													
24													
25													
26													
27													

The best possible answer to this problem is a total profit of \$35,860. Note how *What'sBest!* successfully met the minimum steel needs of each plant while efficiently using the other raw materials on hand.

# Waste Minimization in Stock Cutting

File name: CUTSTOCK.XLSX

TYPE: LINEAR OPTIMIZATION

## Application Profile

Consider a product produced in rolls or sheets — fabric, sheet metal, or carpeting. A manufacturer of this product is constantly faced with a problem. His machinery produces rolls of a single standard width, but he must sell to an unstandardized marketplace. This model applies linear programming to the problem of cut patterns. Given the sizes required, the amount of each size demanded, and the cut patterns available, the model minimizes the waste cost associated with meeting demand.

## The Problem in Words

You're the production manager in a sheet metal plant. You turn out rolls of sheet metal of a particular width. Your customers use your product in different ways requiring rolls of different widths. To accommodate their needs, you can cut a roll of sheet metal into more than one narrower roll. Your goal is to waste as little of the sheet metal as possible by choosing patterns that best utilize the width of a roll and closely matching the length requirements of various sizes. Each wasted edge strip and each length of metal cut to an unneeded width adds to your total waste cost. You must select cut patterns that meet customer needs and minimize total waste costs.

## Background

Your factory produces sheet metal in various widths that you cut from 100 inch widths. In order to meet customer demand, you must produce rolls of these widths and footage:

<u>Width</u>	<u>Total Footage</u>
35"	1,020
25"	3,000
18"	967
15"	1,450

For each roll of 100" metal, you select one of four cut patterns:

<u>Pattern</u>	<u>A</u>	<u>B</u>	<u>C</u>	<u>D</u>
Rolls	35"	35"	25"	35"
cut into	25"	35"	25"	25"
widths	18"	15"	25"	15"
of:	18"	15"	25"	15"

Schematically, the patterns look like this:

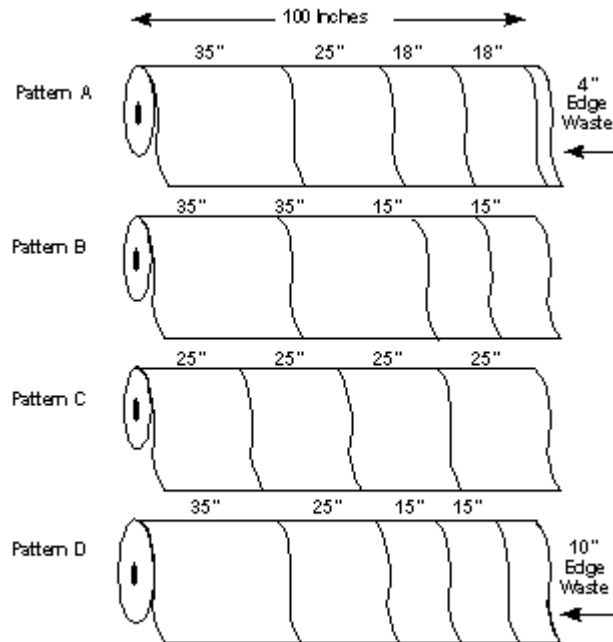

Each length of 100" metal must be cut into one of these patterns, but how many feet should be cut using each pattern?

### Objective of Optimization

Your objective is to minimize the total waste cost — the sum of edge waste and end waste. How many feet of each pattern should you cut in order to meet customer demand at the lowest cost?

## The Worksheet

Let's examine the *CUTSTOCK* sample file and see how the edge waste and end waste are calculated.

### The *CUTSTOCK* Worksheet *Before* Optimization

Widths To Cut in Inches:	15	18	25	35	Feet Cut/ Pattern	Edge Waste In... Ins.	\$
Pattern:							
A	0	2	1	1	0.00	4	\$0
B	2	0	0	2	0.00	0	\$0
C	0	0	4	0	0.00	0	\$0
D	2	0	1	1	0.00	10	\$0
Cut:	0	0	0	0			
Need:	1450	967	3000	1020			
	Not >=	Not >=	Not >=	Not >=			
End Waste In... Inches	-1450	-967	-3000	-1020		Stock Width Inches: 100	
\$	(\$16,313)	(\$13,055)	(\$56,250)	(\$26,775)		End Waste Cost Per Inch/Ft. \$0.75	
			Total End Waste Cost: (\$112,392)			Edge Waste Cost Per Inch/Ft. \$1.50	
			Total Edge Waste Cost: \$0				
			Total Waste Cost: (\$112,392)				

In B4:B7, the number of cuts of the 15 inch width is entered for each pattern (e.g., pattern *A* has no 15 inch cuts, and pattern *B* has two, as shown in the schematic on the previous page). The total *Cut* cells (B9:E9) display the footage cut to each width. In G4:G7, *Edge Waste* in inches is shown. *Edge waste* is the total of inches cut per pattern subtracted from the stock width of 100 inches. *End Waste* in inches (B13:E13) is the amount cut less the amount needed.

#### A. Determine Adjustable Cells

The adjustable cells in this model are the *Feet Cut/Pattern* (F4:F7). They contain the number of feet to be cut into each of the four available patterns.

#### B. Define Best

The best solution to this worksheet is the combination of cut patterns that minimizes total *Waste Costs* while meeting the required footage for each width. The value of *Total Waste Costs* is located in cell E19, and is the sum of the edge waste costs resulting from each cut pattern, and the end waste costs of excess footage of any width produced.

### C. Specify Constraints

The constraints in this problem are simply that the production of sheet metal in each of the four widths must meet the amount demanded. The requirements for 15, 18, 25, and 35 inch sheet metal appear in B10:E10. The actual footage of each width resulting from the selected *Cut* patterns is tallied using formulas in B9:E9. B11:E11 contain constraints forcing these requirements to be met. The formula for 15" *End Waste* in B11, for example, is  $WB(B9,">=";B10)$ . This ensures that actual footage (B9) is at least equal-to the required amount (B10).

Now, you're ready to solve the model.

#### The *CUTSTOCK* Worksheet *After* Optimization

	A	B	C	D	E	F	G	H	I
1	Widths To Cut in Inches:					Feet Cut/Pattern	Edge Waste In...		
2		15	18	25	35		Ins.	\$	
3	Pattern:								
4	A	0	2	1	1	483.50	4	\$2,901	
5	B	2	0	0	2	0.00	0	\$0	
6	C	0	0	4	0	447.88	0	\$0	
7	D	2	0	1	1	725.00	10	\$10,875	
8									
9	Cut:	1450	967	3000	1208.5				
10	Need:	1450	967	3000	1020				
11		=>=	=>=	=>=	>=				
12	End Waste In...						Stock Width		
13	Inches	0	0	0	188.5		Inches:	100	
14	\$	\$0	\$0	\$0	\$4,948				
15							End Waste Cost		
16							Per Inch/Ft.	\$0.75	
17						Total End Waste Cost:			
18						\$4,948	Total Edge Waste Cost:		
19						\$13,776	\$18,724	Edge Waste Cost	
20							Per Inch/Ft.	\$1.50	
21									
22									

The solution to the *CUTSTOCK* model is a *Total Waste Cost* of \$18,724 ( \$13,776 *Edge Waste* (E18) and \$4,948 *End Waste* (E17)). Rounding may give a slightly different answer. Here's a schematic of the solution.

**Note:** If multiple raw material types were available, this model would be reformulated to minimize total material costs. Otherwise, very expensive material might be purchased, although it would be used efficiently. Another model might also take into account the value of *End Waste* that could be re-entered in inventory.



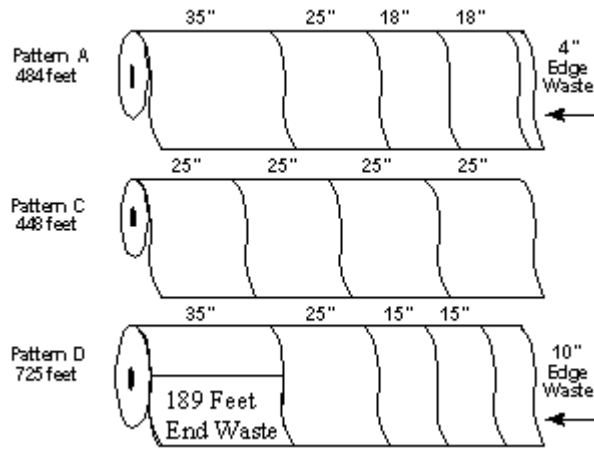

Note that the optimized cutting plan includes no footage cut to *Pattern B*, in cell G5. Also, end waste occurs only in the 35" width (E13).

# Plant Location

*File name: PLANTLOC.XLSX*

*TYPE: LINEAR OPTIMIZATION*

---

This problem is related to the class of network or routing problems. In such problems, the variables usually include multiple choices of transportation routes to and from a number of points of origin and destination, with differing shipping and operating costs associated with each possible route.

The *Plant Location* problem is similar to the *SHIPPING* sample model, but allows greater latitude of decision-making in that the points of origin (plant locations) are variable. Manufacturers and wholesale businesses are likely to encounter problems of this sort in matching existing customer demand to product availability and minimal transportation costs.

## Background

Your firm has a choice of five locations in which to operate a manufacturing facility. Six markets exist with a demand for your product. Each potential plant has an associated monthly operating cost, and shipping routes to the demand cities have varying costs. In addition, each potential plant will have a production capacity that must not be exceeded.

## Objective of Optimization

The objective is to locate plants in such a way that demand is satisfied in each target city, potential plant capacity is not exceeded, and overall operating costs are minimized.

---

## The Worksheet

Let's open the *PLANTLOC* sample and examine its layout and formulas.

### The *Shipping Costs* Worksheet *Before Optimization*

The screenshot shows the following data in the 'Shipping Costs' worksheet:

PLANT LOCATION MODEL										
<u>Shipping Costs Per Ton / Month</u>										
Proposed Supply City:	Demand City						Monthly Fixed Cost	Open Plant	Oper. Cost	
	Atlanta	Boston	Chicago	Denver	Omaha	Portland				
Baltimore	1675	400	685	1630	1160	2800	\$7,650	0	\$0	
Cheyenne	1460	1940	970	100	495	1200	\$3,500	0	\$0	
Salt Lake City	1925	2400	1425	500	950	800	\$5,000	0	\$0	
Memphis	380	1355	543	1045	665	2321	\$4,100	0	\$0	
Wichita	922	1646	700	508	311	1797	\$2,500	0	\$0	
Trans. Cost	\$0	\$0	\$0	\$0	\$0	\$0	Operating Cost:		\$0	
							Trans. Costs:		\$0	
<b>TOTAL OPERATING COST:</b>									<b>\$0</b>	

## The Amount Shipped Worksheet Before Optimization

Proposed Supply City:	Atlanta	Boston	Chicago	Denver	Omaha	Portland	Monthly Supply Limitation	Capacity in Tons
Baltimore	0.0	0.0	0.0	0.0	0.0	0.0	=<=	18.0
Cheyenne	0.0	0.0	0.0	0.0	0.0	0.0	=<=	24.0
Salt Lake City	0.0	0.0	0.0	0.0	0.0	0.0	=<=	27.0
Memphis	0.0	0.0	0.0	0.0	0.0	0.0	=<=	22.0
Wichita	0.0	0.0	0.0	0.0	0.0	0.0	=<=	31.0

Plant Demand	Not >=	Not >=	Not >=	Not >=	Not >=	Not >=
Demand:	10.0	8.0	12.0	6.0	8.0	11.0

### A. Determine Adjustable Cells

The adjustable cells in *PLANTLOC* are the quantities shipped from each potential plant to each demand city (B9:G13 on the *Amount Shipped* worksheet) and the number of plants open at each location (I9:I13 of the *Shipping Costs* worksheet).

In addition, since either a whole plant or none at all must be erected at any location, I9:I13 of the *Shipping Costs* worksheet are specified as binary integers. What'sBest! will return only a zero or one as values in these cells.

### B. Define Best

The best solution consists of minimizing *Total Operating Cost* in cell J18 of the *Shipping Costs* worksheet. This cell contains the sum of the two subtotals for *Operating Costs* and *Transportation* costs in cells J15 and J16 of the *Shipping Costs* worksheet, respectively. The *Transportation* cost subtotal, in turn, is the sum of the values in cells B16:G16 of the *Shipping Costs* worksheet. The formulas in these cells represent the total shipping costs to the city in question from all plant locations. For instance, the formula in cell B16 is `SUMPRODUCT(B9:B13, 'Amount Shipped'! B9:B13)`.

### C. Specify Constraints

The two blocks of constraints in the *Plant Locating* problem ensure that demand is satisfied in the six cities and that production capacity at each of the five potential plants is not exceeded.

First, since demand in B16:G16 of the *Amount Shipped* worksheet must be met, the constraints in B15:G15 of the same worksheet require the sum of amount shipped to each demand city (*Atlanta, Boston, etc.*) to be greater-than-or-equal-to the demand for that city.

The second constraint is that the amount shipped from each *Supply City* (*Baltimore, Cheyenne, etc.*) must not exceed its supply capacity. To enforce this constraint, the constraints in H9:H13 of the *Amount Shipped* worksheet require that the sum of materials shipped from each *Supply City* is less-than-or-equal-to the *Monthly Supply Capacity* for that city (I9:I13 of the *Amount Shipped* worksheet). Let's look at the formula in H9 of the *Amount Shipped* worksheet:

$$WB(SUM(B9:G9), "<=" , I9 * Shipping Costs! I9)$$

The total amount shipped from Baltimore,  $SUM(B9:G9)$ , can be no more than  $I9 * Shipping Costs I9$ , Baltimore's capacity. Since *Shipping Costs I9* is either 1 or 0, depending on whether or not a plant is open in Baltimore, its use in the formula returns a nonzero value only if the plant is opened.

Now, let's solve the model.

The *Shipping Costs* Worksheet After Optimization

PLANT LOCATION MODEL														
Shipping Costs Per Ton / Month														
Proposed Supply City:	Demand City						Monthly Fixed Cost	Open Plant	Oper. Cost					
	Atlanta	Boston	Chicago	Denver	Omaha	Portland								
Baltimore	1675	400	685	1630	1160	2800	\$7,650	1	\$7,650					
Cheyenne	1460	1940	970	100	495	1200	\$3,500	1	\$3,500					
Salt Lake City	1925	2400	1425	500	950	800	\$5,000	0	\$0					
Memphis	380	1355	543	1045	665	2321	\$4,100	1	\$4,100					
Wichita	922	1646	700	508	311	1797	\$2,500	0	\$0					
Trans. Cost							\$3,800	\$3,200	\$6,658	\$600	\$4,130	\$13,200	Operating Cost:	\$15,250
							Trans. Costs:		\$31,588			TOTAL OPERATING COST:	\$46,838	

## The Amount Shipped Worksheet After Optimization

		Amount Shipped						Monthly Supply Capacity
Proposed Supply City:	Demand City	Atlanta	Boston	Chicago	Denver	Omaha	Portland	Limitation in Tons
Baltimore		0.0	8.0	1.0	0.0	0.0	0.0	<= 18.0
Cheyenne		0.0	0.0	0.0	6.0	7.0	11.0	=<= 24.0
Salt Lake City		0.0	0.0	0.0	0.0	0.0	0.0	=<= 27.0
Memphis		10.0	0.0	11.0	0.0	1.0	0.0	=<= 22.0
Wichita		0.0	0.0	0.0	0.0	0.0	0.0	=<= 31.0
Meet Demand		=>=	=>=	=>=	=>=	=>=	=>=	
Demand:		10.0	8.0	12.0	6.0	8.0	11.0	

Plants are open in *Baltimore*, *Cheyenne*, and *Memphis* (I9, I10, and I12 of the *Shipping Costs* worksheet). *Total Operating Cost* in J18 of the *Shipping Costs* worksheet has been minimized to the optimally low figure of \$46,838. Since the constraint in H9 of the *Amount Shipped* worksheet is not binding, you know that additional sales out of *Baltimore* are possible.

# Staff Scheduling

File name: STAFF.XLSX

TYPE: LINEAR OPTIMIZATION

## Application Profile

In *Staff Scheduling* problems, the goal is to meet specified manpower requirements at minimum cost. In general, the schedule must meet certain conditions, such as those imposed by regulations or union contracts, including minimum shift length, number of work breaks, or maximum overtime hours.

These models have applications in the scheduling of airline flight crews, hospital and office staffs, and restaurant personnel, to name just a few.

## The Problem in Words

You are running a business with daily staff needs on varying work loads each day of the week.

## Background

The daily staff needs range from 110 to 190 people as shown below:

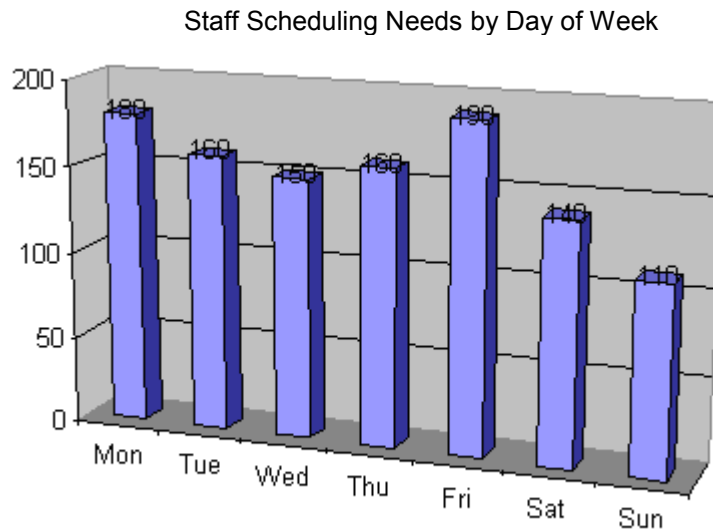

In addition, there's a labor requirement. Employees must work a five consecutive day workweek, followed by two days off. Thus, the allowable shifts are Monday through Friday, Tuesday through Saturday, Wednesday through Sunday, etc. Each employee earns \$200 per week.

## Objective of Optimization

The objective is to cover staff needs with five-day shifts at minimum weekly payroll cost.

## The Worksheet

Let's look at the *STAFF* worksheet included in the sample files. Look it over for a minute and examine its layout and formulas to see how it has been designed.

### The *STAFF* Worksheet *Before* Optimization

Day	Staff Size	Staff Needs	Number Starting This Day
Mon	0	Not >=	180
Tue	0	Not >=	160
Wed	0	Not >=	150
Thu	0	Not >=	160
Fri	0	Not >=	190
Sat	0	Not >=	140
Sun	0	Not >=	110

Total Employees	0
@	\$200
TOTAL COST:	\$0

#### A. Determine Adjustable Cells

The adjustable cells in this model contain the number of people whose five-day workweeks begin on each day of the week. These are shown in the *Number Starting This Day* column (G7:G13).

#### B. Define Best

The best solution is the one that minimizes total payroll costs. In this problem, cost is equal-to the number of employees times their weekly salary. This is shown in cell G18. The formula for *Total Employees* (G15) is the sum of employees starting each day. The weekly salary per employee has been entered in cell G16. This means that the formula for *Total Cost* in cell G18 is  $G15 * G16$ .

#### C. Specify Constraints

The requirement of any solution to this problem is that *Staff Size* is constrained to be greater-than-or-equal-to *Staff Needs*. Without such a constraint, the job for *What'sBest!* would be easy. The least expensive solution would always be to hire nobody!



Take a look at the *Staff Size* column (C7:C13). The formula for *Staff Size* equals the *Number Starting This Day* plus the total of the number starting for the preceding four days. Remember, each employee has shifts on five consecutive days, so any given day's *Staff Size* equals the five-day total.

For example, the formula for the *Staff Size* on Monday (C7) reads:

$$G7+G10+G11+G12+G13$$

The value in C7 must always be greater-than-or-equal-to the *Staff Needs* for Monday. To ensure this result, a greater-than (" $\geq$ ") constraint was entered in cells D7:D13 with C7:C13 on the left-hand side and E7:E13 on the right-hand side of the equation.

### “What If?” vs. What’sBest!

Try a “What If?” solution to this problem by entering initial estimates of the numbers of employees who will start their five-day workweek on each day (G7:G13). As you meet *Staff Needs* for some days, you begin to violate the constraints for others. Adjust your entries for *Number Starting This Day* to satisfy all the constraints, but be sure to meet all staff requirements. After each estimate, judge your solutions by minimizing *Total Cost* (G18). When you find a solution you might be satisfied with, note your final figure for *Total Cost*.

Now that you have arrived at a “What If?” spreadsheet solution, you’re ready to solve the model.

The STAFF Worksheet After Optimization

Day	Staff Size	Staff Needs	Number Starting This Day
Mon	180	180	80
Tue	160	160	30
Wed	150	150	10
Thu	170	160	50
Fri	190	190	20
Sat	140	140	30
Sun	110	110	0

Total Employees	220
@	\$200
<b>TOTAL COST:</b>	<b>\$44,000</b>

The best possible solution to this problem is a *Total Cost* of \$44,000. Note that the constraints in D7:D13 are all tightly satisfied. That is, there is no overstaffing at all.

#### D. Dual Values

The best solution to this problem recommends starting some people on each day of the week except Sunday. If someone on your staff can only work Sunday through Thursday, you can analyze the model to find what the cost would be of starting this person on Sunday instead of some other day. Do this by using the *Advanced|Dual* command to display in cell H13 the dual value of cell G13, the *Number Starting* on Sunday. Then, solve the model again (Refer to the section *About Dual Values* in Chapter 3, *Additional Commands*, for more information on dual values).

After solving, a dual value of \$67 (0.666) appears in cell H13. This indicates that the total cost would increase by \$67 if one person were to start a workweek on Sunday. You can confirm this by placing a “1” in cell G13, and using the *Remove Adjustable* command to lock the value in place. Then, solve once again.

The total cost of this solution has increased to \$44,067 — an increase of \$67 from the previous best solution, exactly as predicted by the dual value in cell H13. However, you get fractional numbers of employees. To get integer answers, you could round the fractional cell values. One possibility is as follows:

	<u>Round From:</u>	<u>To:</u>
<b>Cell G8, Number Starting on Monday</b>	79.33333	80
<b>Cell G10, Number Starting on Wednesday</b>	19.33333	20
<b>Cell G11, Number Starting on Thursday</b>	39.33333	39
<b>Cell G13, Number Starting on Saturday</b>	29.33333	29

After entering these new integer values in the adjustable cells, you’ll find a new solution with a total of 221 employees and \$44,200 as the minimum cost. Therefore, dual values in this case provide us with the theoretical (since fractional people are imaginary) minimum increase in total cost (\$67), instead of the actual increase in total cost (\$200) for a feasible solution.

**Note:** Before using any dual values in a pricing, hiring, or purchasing decision, be sure to investigate the ranges over which they are valid. In some problems, dual values may be valid over only an infinitesimal range. See *Additional Commands*, for a discussion of valid ranges for dual values.

# Staff Scheduling: Preferred Assignment

File name: ASSIGN.XLSX

TYPE: LINEAR OPTIMIZATION

## Application Profile

Staff scheduling is usually a very costly and laborious job. In institutions where there are several daily shifts and the staff can rotate between shifts during the same period, the task is even more complicated. The scheduler must match the organization's requirements with the preferences of individual employees. Larger numbers of employees and longer time periods make the task more difficult.

This problem involves scheduling several staff members in an organization that operates in multiple time shifts each day, seven days a week.

## The Problem in Words

Your business works in three shifts — day, evening, and night. For each shift, you must meet certain minimum staffing levels. Each staff member must be assigned a specific number of shifts and has individual preferences for working the various shifts. Moreover, because of the nature of the work, each employee must have an adequate rest period between shifts in order to perform the job effectively.

This model demonstrates how you can meet your staffing requirements while satisfying your employees' scheduling preferences to the greatest possible degree.

## Background

Your specific staffing needs for a particular week are as follows:

	Staff Members Required						
	Mon	Tue	Wed	Thu	Fri	Sat	Sun
Day	2	1	1	3	1	1	1
Eve	1	1	0	0	2	1	1
Nite	1	0	0	0	1	1	1

Your staff members — *Nixon*, *Ford*, *Bush*, and *Reagan* — must each be assigned to five shifts for the week, and have individually selected their preferred shifts on a descending scale of 5 to 1. These rankings appear on the *Preferences* worksheet of the model.

In addition to considering your staff's preferences, you must abide by two rules in scheduling the shifts:

- ◆ Staff members cannot work more than one shift in a single day
- ◆ After working a shift, a staff member can't work the next two shifts

### Objective of Optimization

The objective is to maximize overall staff preference by assigning employees to the shifts they deem most desirable.

### The Worksheet

Let's open the *ASSIGN* sample file and look it over. The model consists of four worksheets in one workbook.

The *Model* Worksheet Before Optimization

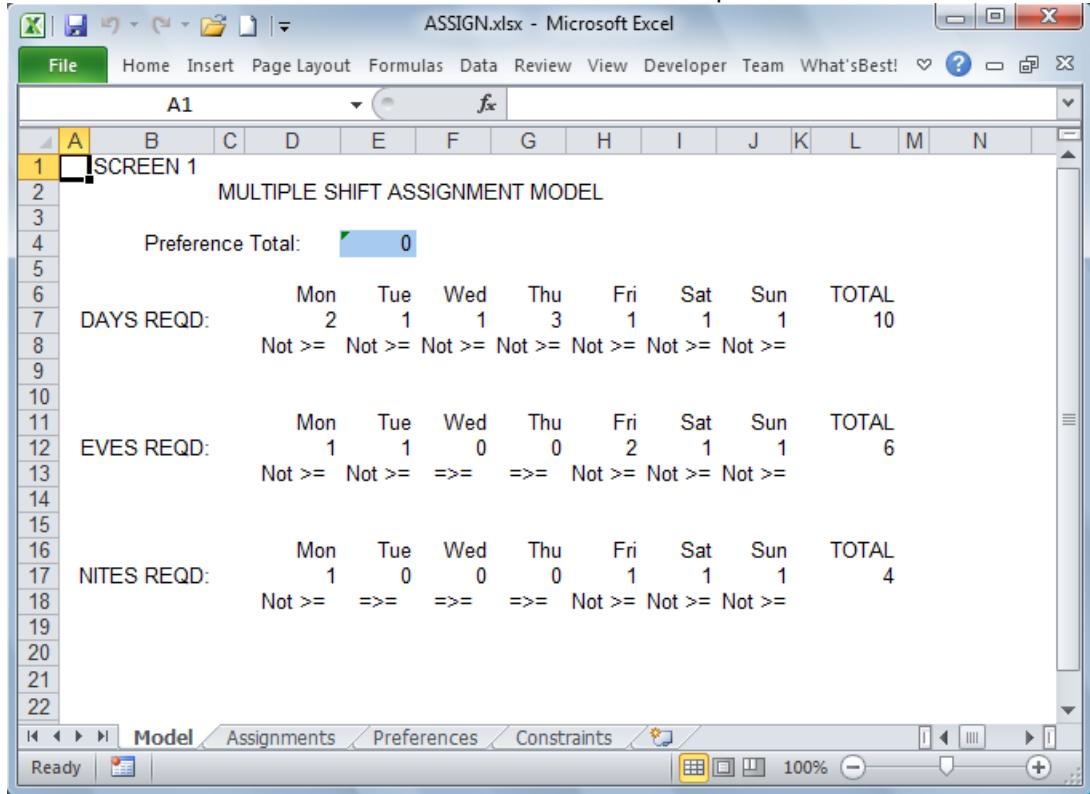







The *Constraints* worksheet contains constraint formulas that ensure each employee works no more than one shift in any 24 hour period.

### A. Determine Adjustable Cells

The adjustable cells in this model are cells D3:J5, D8:J10, D13:J15, and D18:J20 of the *Assignments* worksheet. These are the schedules for the individual staff members.

### B. Define Best

The best solution maximizes the total staff preference (E4 of the *Model* worksheet), which is the sum of the individual preference totals. Individual totals are the product of the shift assignment variables (0 or 1) and the preference values assigned to each shift.

### C. Specify Constraints

The constraints in this problem are:

- ◆ Staffing requirements for each shift must be met.
- ◆ Each staff member must work exactly the prescribed number of shifts during the week—no more and no less.
- ◆ After working one shift, a staff member can't be assigned to the next two consecutive shifts or work more than one shift in a single day.

To assure that the staffing requirements for each shift are met, the constraint formulas in D8:J8 of the *Model* worksheet require the number of people assigned to each shift to be greater-than-or-equal-to the number required. On the Monday *Days* shift (Model D8), for instance, the formula is:

```
=WB(ASSIGNMENTS! D3+ASSIGNMENTS! D8+ ASSIGNMENTS!  
D13+ASSIGNMENTS! D18,">=",D7)
```

This adds the shift assignment variables for the Monday *Day* shift for all four staff members and forces this sum to be greater-than-or-equal-to (at least as great as) the number of people required for that shift.

The model uses an equality constraint for each staff member to force the number of shifts assigned each week to equal the number he's expected to work. The formula in cell L3 of the *Constraints* worksheet, for example, `WB(ASSIGNMENTS! B3,"=",SUM(ASSIGNMENTS! D3:J3))`, forces this equality for *Reagan*. Assigning him to more than 5 shifts causes the constraint to return "Not =".

Finally, the model must assure that, after working one shift, a staff member isn't assigned to either of the following two shifts and that each staff member is assigned to only one shift per day. This is accomplished by summing the assignment variables (0's and 1's) for each set of three consecutive shifts and forcing that total to be less-than-or-equal-to one. If, for instance, a staff member were assigned to two shifts out of a consecutive block of three, the constraint would be violated. Examine the formula in D3 and D4 of the *Constraints* worksheet, `WB(SUM(ASSIGNMENTS! D3:D5),"<=", 1)` and `WB(ASSIGNMENTS! D4+ASSIGNMENTS! D5+ ASSIGNMENTS! E3,"<=", 1)`, which excludes *Reagan* from working more than one of the three Monday shifts or more than one of three shifts beginning with Monday *Evening*, respectively.



You're now ready to solve the problem.

### Model Worksheet in *ASSIGN After Optimization*

SCREEN 1

MULTIPLE SHIFT ASSIGNMENT MODEL

Preference Total: 50

	Mon	Tue	Wed	Thu	Fri	Sat	Sun	TOTAL
DAYS REQD:	2	1	1	3	1	1	1	10
	=>=	=>=	=>=	=>=	=>=	=>=	=>=	
EVES REQD:	1	1	0	0	2	1	1	6
	=>=	=>=	=>=	=>=	=>=	=>=	=>=	
NITES REQD:	1	0	0	0	1	1	1	4
	=>=	=>=	=>=	=>=	=>=	=>=	=>=	

The solution returns a *Preference Total* of 50. The scheduling requirements are tightly satisfied — no overstaffing has occurred — and each employee has been assigned to three or more preferred shifts.

# Staff Scheduling: Two Stage Fixed Shift

File name: FIXED1.XLSX, FIXED2.XLSX

TYPE: LINEAR OPTIMIZATION

## Application Profile

Many organizations staff their personnel according to a number of non-overlapping daily shifts. Manufacturing plants, hospitals, and banks usually have 2 or 3 shifts per day with prespecified durations and starting times. For example, a hospital might have 3 daily shifts, each 8 hours in length, with 8:00 am, 4:00 pm, and midnight as the starting times. In this model, you need to fill these shifts at the lowest cost (i.e., with minimal overstaffing).

Another consideration is that worker preferences for certain shifts should be satisfied as much as possible. In fact, these may be not only preferences, but requirements under union work agreements. Here's a two-stage model for this specific situation.

## Stage 1: Cost Minimization

### The Problem in Words

The first stage is to determine the lowest-cost schedule that meets all staffing requirements. You can determine this schedule independent of specific personnel availability or characteristics.

You know staffing requirements for each day of the week. It's not important how these daily requirement figures are obtained, as long as they accurately reflect staffing needs. They could be based on the output of another model (such as a queuing model) or an extrapolation of historical figures. We also make the following assumptions in this model:

- ◆ There is only one skill level of staff — employees are interchangeable.
- ◆ Staffing requirements or *Full Time Equivalent* requirements (FTEs) can be met with either full time employees working five days per week or part time (or pool) employees that can be hired on a daily basis.
- ◆ Each full time employee cannot work more than 4 days in a row.

You could incorporate other assumptions with minor changes to the model.

### Background

An employee's schedule for one time period is called a *work pattern*. Each employee can be scheduled under one of several work patterns. For example, a full time employee working five days a week can either work Monday through Friday or Tuesday through Saturday. These work patterns can be represented as follows:

Pattern #	Mon	Tue	Wed	Thu	Fri	Sat	Sun
1	1	1	1	1	1	0	0
2	0	1	1	1	1	1	0

A one indicates that the employee is working, and a zero that he is off.

There may be many patterns consistent with an organization’s work rules. The first step in scheduling is to find a representative sample of patterns that correspond with organization rules or policies and meet other necessary criteria. The example shown here displays 10 patterns. Patterns 11 and 12 may be written in (or any of the supplied patterns may be written over). This process need not be repeated unless there is a change in the policies or rules.

### Objective of Optimization

The objective is to minimize staffing costs for a single shift. The model creates the minimum cost schedule based on daily requirement figures, average cost per employee category, and the work patterns. It chooses the best out of all work patterns that meet the staffing requirements. It also specifies how many people to schedule according to each work pattern and, if desired, how many ‘pool’ people to hire on a temporary basis to satisfy requirements.

### The Worksheet

The model is formulated on the left and far right of the worksheet *FIXED1*. The first screen (A1:N20) contains the staffing and full time equivalent (FTE) requirements and coverage, and cost information:

The *FIXED1* Worksheet (screen 1) *Before Solving*

Day	Scheduled	Recommended	Constraint	Category	Value
Sun	0	Not >=	6	TOTAL FTEs AND POOL DAYS:	
Mon	0	Not >=	8	Recommended FTEs	10.4
Tue	0	Not >=	8	Scheduled FTEs	
Wed	0	Not >=	8	Staff FTEs	0.0
Thu	0	Not >=	8	Pool FTEs	0.0
Fri	0	Not >=	8		
Sat	0	Not >=	6	Total Allocated FTE's	0.0
Sun	0	Not >=	6		
Mon	0	Not >=	8	COSTS PER DAY	
Tue	0	Not >=	8	Staff FTEs	\$120
Wed	0	Not >=	8	Pool Days	\$160
Thu	0	Not >=	8		
Fri	0	Not >=	8		
Sat	0	Not >=	6	TOTAL COSTS	\$0

The second screen (P1:AG20) consists of possible individual schedules (R5:AE16), work patterns, and the adjustable cells (P5:P16):

The *FIXED1* Worksheet (screen 2) *Before Solving*

	Number Assigned	Schedule Number	Available Schedule Patterns							Total Days							
			Su	Mo	Tu	We	Th	Fr	Sa	Su	Mo	Tu	We	Th	Fr	Sa	
4		0															
5	0	1	1	0	1	1	1	1	0	0	1	1	1	1	0	1	10
6	0	2	1	0	1	1	1	1	0	0	1	1	1	0	1	1	10
7	0	3	1	1	0	1	1	1	0	0	1	1	1	1	0	1	10
8	0	4	1	1	0	1	1	1	0	0	1	1	1	0	1	1	10
9	0	5	0	1	1	1	1	0	1	1	0	1	1	1	1	0	10
10	0	6	0	1	1	1	0	1	1	1	0	1	1	1	1	0	10
11	0	7	0	1	1	1	1	0	1	1	1	0	1	1	1	0	10
12	0	8	0	1	1	1	0	1	1	1	1	0	1	1	1	0	10
13	0	9	1	0	1	1	1	1	0	0	1	1	0	1	1	1	10
14	0	10	1	1	1	0	1	1	0	0	1	1	1	1	0	1	10
15	0	11	0	0	0	0	0	0	0	0	0	0	0	0	0	0	0
16	0	12	0	0	0	0	0	0	0	0	0	0	0	0	0	0	0
18		Pool Days	0	0	0	0	0	0	0	0	0	0	0	0	0	0	0

Screen 2 depicts 10 work patterns that incorporate the assumptions and work rules outlined earlier. Each work pattern represents an employee working 5 days a week, 10 days per two week time period. Employees get one out of two weekends off and nobody works more than 4 days at a stretch.

Cell L16 contains the average daily cost per full time employee and cell L17 contains the average daily cost per pool employee. These estimates should be based on accounting and payroll data and can be updated on an as-needed basis.

### A. Determine Adjustable Cells

The adjustable cells are the number of people scheduled according to each work pattern (P5:P16). Pool employees can be added to the model by making cells R18:AE18 adjustable and re-solving.

### B. Define Best

The best solution is the one that results in the minimum total cost in cell L19. Cell L6 contains the aggregate requirement level. L8 and L9 contain the minimum cost staffing levels with breakdown between full time and pool employees. Cell L11 contains the total employees scheduled and cell L19 is the objective of optimization, the total cost figure.

### C. Specify Constraints

The constraints in cells D5:D11 and D13:D19 require that the employees scheduled (C5:C11 and C13:C19) for each day of the scheduling period be greater-than-or-equal-to staffing needs for that day (E5:E11 and E13:E19).

With the ABC's in place, go ahead and solve the model.

The *FIXED1* Worksheet (screen 1) *After Solving* (No Pool)

STAFF SCHEDULING					Fixed Shift		Number Assigned
Scheduled		Recommended		TOTAL FTEs AND POOL DAYS:			
Sun	6	=>=	6	Recommended FTEs	10.4		
Mon	10	>=	8	Scheduled FTEs			
Tue	8	=>=	8	Staff FTEs	12.0		
Wed	12	>=	8	Pool FTEs	0.0		
Thu	10	>=	8	Total Allocated FTE's		12.0	
Fri	8	=>=	8	COSTS PER DAY			
Sat	6	=>=	6	Staff FTEs	\$120		
Sun	6	=>=	6	Pool Days	\$160		
Mon	8	=>=	8	TOTAL COSTS		\$14,400	
Tue	10	>=	8				
Wed	12	>=	8				
Thu	10	>=	8				
Fri	8	=>=	8				
Sat	6	=>=	6				

The *FIXED1* Worksheet (screen 2) After Solving (No Pool)

	Number Assigned	Schedule Number	Available Schedule Patterns							Total Days	
			Su	Mo	Tu	We	Th	Fr	Sa		
4		0									
5	0	1	1	0	1	1	1	1	0	0	1
6	2	2	1	0	1	1	1	1	0	0	1
7	4	3	1	1	0	1	1	1	0	0	1
8	0	4	1	1	0	1	1	1	0	0	1
9	2	5	0	1	1	1	1	0	1	1	0
10	2	6	0	1	1	1	0	1	1	1	0
11	2	7	0	1	1	1	1	0	1	1	0
12	0	8	0	1	1	1	0	1	1	1	0
13	0	9	1	0	1	1	1	1	0	0	1
14	0	10	1	1	1	0	1	1	0	0	1
15	0	11	0	0	0	0	0	0	0	0	0
16	0	12	0	0	0	0	0	0	0	0	0
18		Pool Days	0	0	0	0	0	0	0	0	0

The above screens show the solution when only the cells for full time employees are adjustable. The total cost is \$14,400. The full time staff needed to cover these requirements is 12 people.

**Note:** Though we've illustrated the model without pool employees as part of the solution, you can also use it if you have access to part-time or pool employees and need not rely only on full-timers to meet staffing needs. Just make the cells representing pool (R18:AE18) adjustable before solving. This will result in a \$1,760 saving in this case since, with pool cells adjustable, there's much more flexibility in matching the *Scheduled* personnel with *Recommended* levels.

Sometimes the lowest cost solution results in fractional values for the adjustable cells. Although these fractional numbers provide the lowest cost, they are not practical for implementation purposes, since it's difficult to locate  $2/3$  of a person who is in any condition to work.

Fortunately, though, realistic whole number solutions can be obtained by rounding the fractional answers without sacrificing much in total cost. If the program returns non-integer values in cells P5:P16, or in R18:AE18 when the Pool is used, you can manually round these values to whole numbers. You could also use the *Integer* command to force whole number answers, but this can significantly increase the solution time. The objective in rounding these cells should be to make sure that the *Scheduled*  $\geq$  *Recommended* constraints in D5:D11 and D13:D19 aren't violated and to have a final cost as close as possible to the one before you started rounding.

Now that the lowest-cost schedule has been found, the next step is to assign individual employees to the work patterns selected in this stage by preference.

## Stage 2: Preference Maximization

### The Problem in Words

The second stage model assigns existing staff members to the work patterns selected in stage 1. You know the preferences of each staff member from the ranks of all work patterns selected in stage 1 and the model assigns individuals to work patterns so as to maximize cumulative preference of the group. This model has provisions for specifying employee preference scores for work patterns, and individual seniority levels, performance indices, or a composite of the two.

### Objective of Optimization

The objective of this model is to maximize the cumulative preference of the group while assigning staff members to the minimum-cost work patterns selected in stage 1.

### The Worksheet

This model is also in 2 screens of the worksheet *FIXED2*. Screen 1 contains space for up to 12 individual employee names (B5:B16), the employee seniority-performance index (D5:D16) and space for work pattern preferences (F5:Q16).

Screen 2 contains the adjustable cells, employee names and their assignments and a preference subtotal for each employee.

You must now copy the optimal work patterns selected information from cells P5:P16 of the Stage 1 model after optimization and enter into cells U4:AF4. For this example, we've used the optimal scheduling generated without using *Pool FTE's*.

---

After the data from the first stage is entered, the model looks like this:

The *FIXED2* Worksheet (screen 2) *Before* Optimization

	P	Q	R	S	T	U	V	W	X	Y	Z	AA	AB	AC	AD	AE	AF	AG	AH	AI	
1																					
2						2. EMPLOYEE ASSIGNMENTS TO SCHEDULES															
3	11	12			Schedule #	1	2	3	4	5	6	7	8	9	10	11	12	Single	11	12	
4					Staffed:	0	0	0	2	2	0	0	4	0	4	0	0	0	Assign.		Pref.
5	0	0			LLOYD	0	0	0	0	0	0	0	0	0	0	0	0	0	<=		Sub
6	0	0			DIANE	0	0	0	0	0	0	0	0	0	0	0	0	0	<=		0
7	0	0			TOM	0	0	0	0	0	0	0	0	0	0	0	0	0	<=		0
8	0	0			JOANNE	0	0	0	0	0	0	0	0	0	0	0	0	0	<=		0
9	0	0			DAN	0	0	0	0	0	0	0	0	0	0	0	0	0	<=		0
10	0	0			JIM	0	0	0	0	0	0	0	0	0	0	0	0	0	<=		0
11	0	0			SUSAN	0	0	0	0	0	0	0	0	0	0	0	0	0	<=		0
12	0	0			JOY	0	0	0	0	0	0	0	0	0	0	0	0	0	<=		0
13	0	0			JOHN	0	0	0	0	0	0	0	0	0	0	0	0	0	<=		0
14	0	0			PAM	0	0	0	0	0	0	0	0	0	0	0	0	0	<=		0
15	0	0			SHAOIB	0	0	0	0	0	0	0	0	0	0	0	0	0	<=		0
16	0	0			BEA	0	0	0	0	0	0	0	0	0	0	0	0	0	<=		0
17					Met?	=	=	=	Not	=	Not	=	=	Not	=	=	Not	=	=		
18																					
19					STAFF NEEDS MET:	Not	>=														
20																					
21																					
22																					

A total of 10 people need to be scheduled, 4 each for Schedules 2 and 8, and 2 each for schedules 3 and 5.

Each person's preference score is multiplied by his or her seniority index to get a weighted preference score. Employees are assigned to work patterns according to these weighted scores, with the highest-score employees assigned first. The only exception to this rule occurs when assigning an employee with a high score to a first choice. It may be necessary to assign employees with low weighted scores to their lowest preferences. In such instances, the program would assign the senior employee to the second or third choice so as to benefit the junior staff members. This is in keeping with the objective of maximizing group preference rather than individual preferences.

To follow strict seniority in staff assignment, just use a different scale for seniority/performance scores. For example, vary the scores between zero and 100 rather than 10 and 20. The first scoring scheme would place a much higher emphasis on senior employees than the latter one.

You can tailor the model to meet specific needs with only slight modifications in the structure of input data. The same is true for the stage 1 model.



**A. Determine Adjustable Cells**

The adjustable cells in U5:AF16 of *FIXED1* show whether a person is assigned to a work pattern. There are 12 adjustable cells corresponding to each individual being assigned, indicating what one of the 12 possible work patterns that person is assigned to. A 1 in an employee’s row indicates that he is assigned that column’s schedule number.

**B. Define Best**

The best solution is the one that maximizes total preference score for the group. Total preference is shown in AH19. This is the sum of the preference subtotals for each employee.

**C. Specify Constraints**

Constraints are of the following three types.

- ◆ No more work patterns must be assigned than recommended by the stage 1 optimization (X19),
- ◆ Employees must be assigned to only the work patterns selected in stage 1 (U17:AF17), and
- ◆ Each person should be assigned to only one work pattern (AG5:AG16).

Now, let’s solve the model:

The *FIXED2* Worksheet (screen 2) *After* Optimization

2. EMPLOYEE ASSIGNMENTS TO SCHEDULES																	
	11	12	Schedule #	1	2	3	4	5	6	7	8	9	10	11	12	Single Assign.	Pref. Sub
4	0	0	LLOYD	0	0	0	2	2	0	0	4	0	4	0	0	=<=	30
6	0	0	DIANE	0	0	0	1	0	0	0	0	0	0	0	0	=<=	28
7	0	0	TOM	0	0	0	0	0	0	0	1	0	0	0	0	=<=	36
8	0	0	JOANNE	0	0	0	0	0	0	0	1	0	0	0	0	=<=	15
9	0	0	DAN	0	0	0	0	0	0	0	1	0	0	0	0	=<=	10
10	0	0	JIM	0	0	0	0	1	0	0	0	0	0	0	0	=<=	35
11	0	0	SUSAN	0	0	0	0	0	0	0	0	0	1	0	0	=<=	10
12	0	0	JOY	0	0	0	1	0	0	0	0	0	0	0	0	=<=	35
13	0	0	JOHN	0	0	0	0	0	0	0	0	0	1	0	0	=<=	20
14	0	0	PAM	0	0	0	0	0	0	0	0	0	1	0	0	=<=	18
15	0	0	SHAOIB	0	0	0	0	0	0	0	1	0	0	0	0	=<=	16
16	0	0	BEA	0	0	0	0	0	0	0	0	0	1	0	0	=<=	8
17			Met?	=	=	=	=	=	=	=	=	=	=	=	=		
19	STAFF NEEDS MET: ==>=														PREFERENCE TOTAL: 261		

The maximized preference total in cell AH19 is 150 and the staffing needs established by stage 1 are met. To verify that assignments have been made according to seniority and preference, go back to screen 1 and observe that *Tom*, in row 7, with a seniority level of 9, has rated shift 8 as his highest preference. After solving, *Tom* has indeed been assigned to shift 8.

---

# Pipeline Optimization

File name: PIPELINE.XLSX

TYPE: LINEAR OPTIMIZATION

## Application Profile

This model is an example of a network problem — requiring the movement of resources, at minimum cost, along different routes with which varying costs are associated. With the addition of limits to capacity along the routes, it becomes “capacitated”. Oil and gas pipelines, truck and air routes may be utilized at their highest cost efficiency by applying the principles demonstrated in this model.

## The Problem in Words

As the operator of an oil supply network, you must choose among several available pipelines from two wells to three pumping stations and from the pumping stations to four refineries. Wells have a monthly supply capacity that must not be exceeded; capacities of the pipelines may be limited, and costs vary among the pipelines. In addition, monthly refinery demand must be fully met.

## Background

You must decide how many barrels per month to pump along each pipeline. At present, no pipeline is operating between *Well 1* and *Pump C*, between *Pump A* and *Refineries 3 and 4*, and between *Pump C* and *Refinery 1*. The decision on how much material to send along a given pipeline is governed by the monthly cost per unit on that pipeline and by the necessity of satisfying refinery demand without exceeding monthly well supply.

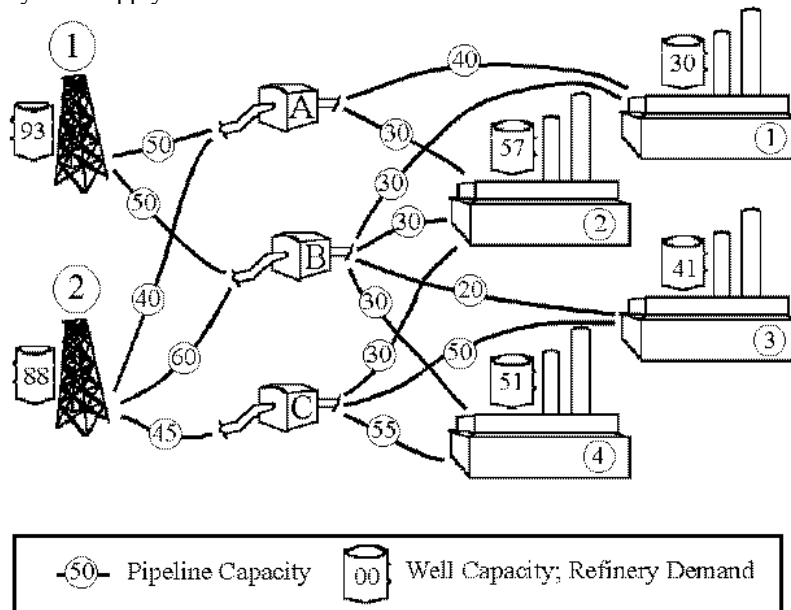

### Objective of Optimization

The objective in this model is to minimize the *Total Pumping Cost* without exceeding either the monthly output capacity of the wells or the capacity of the pipelines, while meeting demand at each refinery.

### The Worksheet

Open the *PIPELINE* sample file and let's have a look at it.

The *PIPELINE* Worksheet *Before* Optimization

PIPELINE NETWORK PROBLEM							
MONTHLY PUMPING VOLUME							
	Pumped From:		Inflow =	To Refinery No.			
	Well 1	Well 2	Outflow	1	2	3	4
Through:							
Pump A	0	0	=	0	0	0	0
Pump B	0	0	=	0	0	0	0
Pump C	0	0	=	0	0	0	0
Capacity:	93	88	Demand:	30	57	41	51
	<=	<=		Not >=	Not >=	Not >=	Not >=
PUMPING COSTS							
	Well 1	Well 2		Ref. 1	Ref. 2	Ref. 3	Ref. 4
Through:							
Pump A	\$1.50	\$3.15		\$5.00	\$7.00	\$0.00	\$0.00
Well Pumping Costs:				\$0.00			
Refinery Pumping Costs:				\$0.00			
Total Pumping Costs:				\$0.00			

---

**A. Determine Adjustable Cells**

The adjustable cells are the amounts sent from the two *Wells* to the three *Pumps* (B7:B8, and C7:C9) and the amounts sent from the three *Pumps* to the *Refineries* (E7:E8, F7:F9, G8:G9, H8:H9). Cells B9, E9, G7, and H7 are fixed cells with a value of zero representing pipelines that are not open.

**B. Define Best**

The best solution to this problem is the one that minimizes *Total Pumping Cost* in cell E37. The formula in E37 is the sum of the two subtotals for *Well* and *Refinery* pumping costs. Each subtotal in turn is the sumproduct of pumping costs along each open pipeline (from the *Wells* to the *Pumps* in the first instance and from the *Pumps* to *Refineries* in the second) and amounts carried on that pipeline.

**C. Specify Constraints**

The constraints in the *PIPELINE* model must perform several functions. First, supply capacity at the *Wells* must not be exceeded. In cells B12 and C12, constraint formulas require that the sum of amounts pumped from each *Well* is less-than-or-equal-to the *Capacities* (B11 and C11).

Second, the amount received at each *Pump* must equal the amount pumped out. Such constraints are known as conservation constraints. To achieve this, cells D7:D9, contain constraint formulas forcing the sum of amounts pumped from the *Wells* to each *Pump* to equal the sum of amounts pumped from that *Pump* to the *Refineries*.

Third, demand at the *Refineries* must be satisfied. These constraints are in cells E12:H12 and require that the sum of amounts pumped from the *Pumps* to each *Refinery* is greater-than-or-equal-to the demands in E11:H11.

Finally, the capacities of the pipelines cannot be exceeded. The constraint formulas in B29:C31 and E29:H31, one for each “arc”, accomplish this result.

---

Now, let's solve the model.

### The PIPELINE Worksheet *After* Optimization

The screenshot shows the following data in the Excel worksheet:

MONTHLY PUMPING VOLUME							
Pumped From:	Inflow =		To Refinery No.				
Well 1	Well 2	Outflow	1	2	3	4	
Through:							
Pump A	50	7	=	30	27	0	0
Pump B	41	36	=	0	30	20	27
Pump C	0	45	=	0	0	21	24
Capacity:	93	88	Demand:	30	57	41	51
	<=	=<=		=>=	=>=	=>=	=>=

PUMPING COSTS							
Through:	Well 1	Well 2		Ref. 1	Ref. 2	Ref. 3	Ref. 4
Pump A	\$1.50	\$3.15		\$5.00	\$7.00	\$0.00	\$0.00

Well Pumping Costs:	\$338.40
Refinery Pumping Costs:	<u>\$1,092.65</u>
<b>Total Pumping Costs:</b>	<b>\$1,431.05</b>

What'sBest! has returned a minimized *Total Pumping Cost* of \$1,431.05. Note that all *Pumps* are in use.

# Shipping Cost Reduction

File name: SHIPPING.XLSX

TYPE: LINEAR OPTIMIZATION

## Application Profile

This problem is typical of the class of network problems that generally involve the shipping of goods through transportation networks or of oil or gas through systems of pipelines.

The particular shipping example illustrates the use of optimization to provide the least-cost distribution for a business that produces a product at many locations, transports it to intermediate warehouses, and then to final consumption or sales locations. Manufacturers, utilities, retail chains, and other distributors are all likely users of shipping optimization systems modeled along similar lines.

## The Problem in Words

You work in the shipping department of a manufacturing business and need to minimize shipping costs while meeting demand without exceeding capacity.

## Background

In this case, two steel mills produce the same product. This product must be sent out to three plant locations. Each location has a demand for the product that must be met and each steel mill has limited manufacturing capacity. Finally, shipping costs vary from each steel mill to each plant.

<b>Shipping Costs Per Unit of Steel</b>		
	<b>From: Steel</b>	<b>Steel</b>
<b>To:</b>	<b>Mill 1</b>	<b>Mill 2</b>
<b>Plant A</b>	\$200	\$500
<b>Plant B</b>	\$300	\$400
<b>Plant C</b>	\$500	\$600

## Objective of Optimization

The objective is to meet all plant demand without exceeding steel mill capacity at minimum shipping cost.

## The Worksheet

Let's look at the *SHIPPING* sample file.

The *SHIPPING* Worksheet Before Optimization

	From		From		Demand	Demand	
	Shipped	Steel Mill 1	@ Cost	Steel Mill 2	@ Cost	Constraint	by Plant
To							
Plant A	0	\$200	0	\$500	Not >=	50	
Plant B	0	\$300	0	\$400	Not >=	90	
Plant C	0	\$500	0	\$600	Not >=	80	
	Output	Capacity	Output	Capacity			
	0 <=	100	0 <=	150			
Costs	\$0		\$0		Total Cost:	\$0	

**A. Determine Adjustable Cells**

The adjustable cells in this model are the quantities to be shipped from each steel mill to each plant (B6:B8 and E6:E8).

**B. Define Best**

The best solution minimizes *Total Cost* in cell I12. The *Total Cost* formula is the sum of the two *Cost* per *Mill* cells in B12 and E12. Each of these is the sumproduct of the *Units Shipped* from each *Mill* to each *Plant* (B6:B8 and E6:E8) and the cost associated with each shipping arc (D6:D8 and G6:G8).

**C. Specify Constraints**

There are two sets of constraints. First, each plant location requires certain levels of shipments. Second, the production of each steel mill must not exceed its capacity.

The constraints in H6:H8 force the total shipped to each plant to be greater-than-or-equal-to that plant's demand (I6:I8).

To guard against exceeding the capacity of a *Steel Mill*, the capacity constraints in C11 and F11 require that a *Steel Mill's* output (the sum of amounts shipped from it) be less-than-or-equal-to that *Mill's* capacity.



Now, let's solve the model.

### The SHIPPING Worksheet After Optimization

The screenshot shows the following data in the SHIPPING worksheet:

SHIPPING COST REDUCTION							
Total Units Shipped	From Steel Mill 1	@ Cost	From Steel Mill 2	@ Cost	Demand Constraint	Demand by Plant	
To Plant A	50	\$200	0	\$500	=>=	50	
Plant B	0	\$300	90	\$400	=>=	90	
Plant C	50	\$500	30	\$600	=>=	80	
Costs	\$35,000		\$54,000		Total Cost:	\$89,000	

The least-cost solution results in shipping costs of \$89,000.

#### D. Dual Values

The solution recommends shipping nothing from *Mill 2* to *Plant A*. To find out how much your total cost will increase if you transport anything between these two points, use the *Advanced|Dual* command to display in an empty cell the dual value for cell E6. Then, optimize again and you'll find a dual value of 200. This means that your *Total Cost* would increase by \$200 if you were to ship one unit along that arc.

If you perform the same operation for cell B7, the amount shipped from *Mill 1* to *Plant B*, you'll find a dual value of zero. Dual values are generally positive for adjustable cells that have a zero value in the solution. An exception to this occurs in cases where there are multiple solutions, as in the current problem. Because no penalty is incurred in moving from one optimal solution to another, such a problem is said to have multiple optima — there is more than one combination of adjustable cells that give the same minimum cost.

---

# Traffic Congestion Cost Minimization

File name: TRAFFIC.XLSX

TYPE: NONLINEAR OPTIMIZATION

---

## Application Profile

In the earlier *SHIPPING* network problem, the cost to transport your product from a supply point to a demand point was fixed. However, in some network problems, the costs vary with the amount transported along each arc. If you've ever driven to or from a major city during rush hour, you've experienced this phenomenon. As the number of cars on the road increases, the cost, in terms of time required, of getting from point *A* to point *B* increases. In many cases, the cost does not increase linearly. For example, doubling the traffic on a lightly traveled road may not double the travel time, but doubling the traffic again may effectively grind the flow of vehicles nearly to a halt.

## The Problem in Words

As Quartermaster of a military base, you need to distribute uniforms from three warehouses to four intake centers within the base.

## Background

You know that the time required to go from a particular warehouse to a particular unit obeys the following formula:

$$Time = Rate * Flow / ( 1 - Flow / Limit )$$

Where:

*Rate* = time required to transport one unit if there is no congestion along this route

*Flow* = amount of product moving along this route

*Limit* = the maximum amount that can be moved along this route

You also know the rates and limits for each route, or arc, in the network.

## Objective of Optimization

The objective is to ship all the uniforms to the *Intake Centers* at minimum cost, while satisfying demand at each center.

---

## The Worksheet

Let's look at the sample file *TRAFFIC*.

### The *TRAFFIC* Worksheet Before Solving

	A	B	C	D	E	F	G	H	I	J	K
1											
2											
3											
4											
5	Warehouse 1	100.0	100.0	100.0	100.0	400	Not =	1100			
6	Warehouse 2	100.0	100.0	100.0	100.0	400	Not =	700			
7	Warehouse 3	100.0	100.0	100.0	100.0	400	Not =	1300			
8	Total	300	300	300	300						
9		Not =	Not =	Not =	Not =						
10	Demand	900	1200	600	400						
11											
12											
13	Warehouse 1	39	14	11	14						
14	Warehouse 2	27	9	12	9						
15	Warehouse 3	24	14	17	13						
16											
17											
30	Warehouse 2	3375	1029	1371	1029						
31	Warehouse 3	2743	1680	2040	1560						
32											
33	Epsilon =	0.01				Total Cost =		24035			
34											

#### A. Determine Adjustable Cells

The adjustable cells are the amounts shipped along each arc from *Warehouse* to *Intake Center*, in B5:E7.

#### B. Define Best

The best solution, in C36, is the minimized sum of all time penalties.

#### C. Specify Constraints

There are three groups of constraints in the model. In G5:G7, the *Total* shipped from each *Warehouse* (F5:F7) is forced to be equal-to its total *Supply* (H5:H7). In B9:E9, the amount shipped to each intake center (B8:E8) is forced to be equal-to its demand (B10:E10). In B23:E25, the amount shipped along each route (B5:E7) is required to be less-than-or-equal-to that route's maximum capacity minus *Epsilon*, .01, in cell B33 (see note below).

**Note:** As traffic *Flow* approaches the *Limit*, the *Time Penalty* goes to infinity. Observe, for instance, the formula for *Warehouse 1*  $\Rightarrow$  *Unit 1* in cell B23:  $B13*B5/(1-B5/B18)$ . When *Flow* ( $B5$ ) = *Limit* ( $B18$ ), the formula to calculate time is undefined because it results in division by zero. The user should build models that avoid such mathematically undefined regions. Therefore, rather than constraining the flow along each route to be less-than-or-equal-to its limit, we've constrained it to be less-than-or-equal-to the limit minus a small amount we call *Epsilon*.

Now, let's solve the model:

The *TRAFFIC* Worksheet *After Solving*

TRAFFIC FLOW									
	Unit 1	Unit 2	Unit 3	Unit 4	Total	=	Supply		
Warehouse 1	200.8	456.4	311.2	131.6	1100	=	1100		
Warehouse 2	239.4	409.8	49.8	1.0	700	=	700		
Warehouse 3	459.8	333.8	238.9	267.5	1300	=	1300		
Total	900	1200	600	400		=			
Demand	900	1200	600	400					
RATE									
Warehouse 1	39	14	11	14					
Warehouse 2	27	9	12	9					
Warehouse 3	24	14	17	13					
LIMIT									
Warehouse 2	12402	7562	637	9					
Warehouse 3	25946	10534	6750	6274					
Epsilon =	0.01	Total Cost =			102049				

# Truck Loading

File name: TRUCK.XLSX

TYPE: LINEAR OPTIMIZATION

## Application Profile

This is an example of the *Knapsack* class of problems, in which a number of things — boxes, books, or Bradley Fighting Vehicles — must be efficiently or profitably packed in a container (trucks, crates, or C130 aircraft). The objective can be to minimize wasted space in the container, to maximize or minimize total load weight, or, as in this case, to maximize the value of the load.

## The Problem in Words

You have to decide which items to load on a truck. Each item must be shipped in its entirety or not at all (i.e., 25% of an item cannot be shipped). The *Truck Loading* problem illustrates a situation in which non-integer (fractional) answers are not acceptable. To demonstrate potential problems involved in rounding fractional answers, we'll solve the problem using two different methods.

In the first case, we'll use *What'sBest!* to optimize by the conventional method. The solution may suggest fractional answers, but we'll just round the fractions to the nearest whole number that does not violate any constraints. In the second case, we'll find an integer solution using the binary Integer command.

## Background

Items are to be loaded onto a truck with a 10,000 pound capacity. However, the items currently scheduled for shipment will exceed the capacity of the truck, so you have to make a yes/no decision as to whether each item gets shipped.

Each item has an associated dollar value and weight as shown below.

### Dollar Value and Weight for Each Item

<u>Item</u>	<u>Value</u>	<u>Weight</u>
1	\$22,500	7,500 lbs.
2	\$24,000	7,500 lbs.
3	\$ 8,000	3,000 lbs.
4	\$ 9,500	3,500 lbs.
5	\$11,500	4,000 lbs.
6	\$ 9,750	3,500 lbs.

## Objective of Optimization

The objective of optimization is to maximize the total value of the items loaded onto the truck without exceeding the truck's weight capacity.

## The Worksheet

Let's look at the *TRUCK* sample file. The six items scheduled for shipment (A6:A11) along with their corresponding dollar *Values* (B6:B11) and *Weights* (C6:C11) appear in the worksheet.

### *TRUCK* Worksheet Before Optimization by Conventional Method

Item	Value	Weight	Proportion Loaded	Maximum Proportion Loaded
1	\$22,500	7500	0	1
2	\$24,000	7500	0	1
3	\$8,000	3000	0	1
4	\$9,500	3500	0	1
5	\$11,500	4000	0	1
6	\$9,750	3500	0	1
Total Value of Load:		Total Weight of Load:	Maximum Load Weight	
\$0		0	10000	

### A. Determine Adjustable Cells

The adjustable cells are the *Proportion Loaded* of each item, in D6:D11.

### B. Define Best

The best solution is the one that maximizes the value of the load in cell B15. The formula there, *SUMPRODUCT*(B6:B11,D6:D11), multiplies each individual item's value times the *Proportion Loaded* and sums them.

### C. Specify Constraints

There are two constraints. The first, in D15, specifies that the *Total Weight of Load* (C15) remain less-than-or-equal-to the *Maximum Load Weight* (E15). The second, in E6:E11, requires that the number of each item loaded onto the truck is less-than-or-equal-to 1.

Now, let's solve the worksheet.

*TRUCK Worksheet After Optimization by Conventional Method*

TRUCK LOADING						
	Item	Value	Weight	Proportion Loaded		Maximum Proportion Loaded
6	1	\$22,500	7500	0.33333333	<=	1
7	2	\$24,000	7500	1	=<=	1
8	3	\$8,000	3000	0	<=	1
9	4	\$9,500	3500	0	<=	1
10	5	\$11,500	4000	0	<=	1
11	6	\$9,750	3500	0	<=	1
14	Total Value of Load:		Total Weight of Load:		=<=	Maximum Load Weight
15	\$31,500		10000			10000

You'll notice that the *What'sBest!* solution recommends loading 33% of item 1 and all 100% or ("1") of item 2. While this is the best solution if fractions of items can be loaded, it may be difficult to load (or sell) one-third of a piano. To eliminate the fractions, you could do some "What If?" trials and round them in the direction that doesn't violate the maximum load constraint.

If you round the proportion up to 1.00, the weight of the load increases to 15,000 pounds. This violates the 10,000 pounds maximum weight constraint. Instead, round the fraction of item 1 down to zero. This drops the value of the load to 7,500 pounds, leaving 2,500 pounds of load capacity unused. No other item weighs less-than 2,500 pounds, so the truck can't be filled up further.

Rounding fractional weights, as in the conventional method, the truck would carry only item 2 for a load weight of 7,500 pounds and a load value of \$24,000.

**The Binary Integer Method**

This problem can be converted very simply to give an integer solution — one with no fractional weights for an item. Use the binary *Integer* command to specify that the adjustable cells in D6:D11 cannot be anything other than zero or one. You could also eliminate the constraints in E6:E11 and the constants in F6:F11, which are now superfluous.

The re-optimized solution should look like the following:

The *TRUCK* Worksheet in Integer form *After Optimization*

Item	Value	Weight	Proportion Loaded	Maximum Proportion Loaded
1	\$22,500	7500	0	
2	\$24,000	7500	0	
3	\$8,000	3000	1	
4	\$9,500	3500	1	
5	\$11,500	4000	0	
6	\$9,750	3500	1	

Total Value of Load:	Total Weight of Load:	Maximum Load Weight
\$27,250	10000	10000

Constraint:  $\leq$

Note that *What'sBest!* has returned a value of 1 in the *Proportions Loaded* cells of *Items* 3, 4, and 6 and a 0 for the remaining items. This results in a total load weight of 10,000 pounds, and a total load value of \$27,250. This total load value is \$3,250 greater-than that achieved by rounding fractional answers.

### Rounding versus Integer Solutions

The important things to notice about the integer solution are that the truck's capacity is more fully utilized and, more importantly, that the value of the load is \$3,250 higher.

As a rule, rounding of fractional answers is effective when it results in large integers. When the integers are small, as in this problem, rounding is less effective.



# Crop Allocation Under Uncertainty

File name: SP\_CROPALLOC.XLSX

TYPE: LINEAR OPTIMIZATION -  
STOCHASTIC

## Application Profile

The stochastic farm allocation model is an example of a single stage stochastic optimization problem. In this problem, a random event occurs at stage 1 of the process. To handle this random event, a decision has to be made at stage 0. This decision tries to optimize an objective function over all the possible realizations of the random event.

## The Problem in Words

A farmer can grow wheat, corn or beans on his 500 acres of farm land. He requires 200 tons of wheat and 240 tons of corn to feed his cattle. For domestic use, he requires 100 tons of beans.

He can either grow these crops or buy them from the market. The plantation cost for the crops is given by \$150 /acre (wheat), \$230 /acre (corn) and \$260 /acre (beans). The crops can be sold in the market at \$170 /ton (wheat), \$150 /ton (corn) and \$200 /ton (beans). Any shortfall can be purchased from the market at \$238 /ton (wheat) and \$210 /ton (corn) and \$270 /ton (beans).

The yields (in tons /acre) of the crops depend on the weather. The farmer believes that the weather can be good, fair, bad, or very bad with equal probability. If the yield of a crop is 'y' in fair weather, then the variation of the yield with weather is given by:

Good	1.2y
Fair	y
Bad	0.8y
Very bad	0.6y

The yields (in tons/acre) of the various crops under the various weather scenarios are:

	Wheat	Corn	Beans
Good	3	3.6	24
Fair	2.5	3	20
Bad	2	2.4	16
Very bad	1.5	1.8	12

The farmer has to decide how much land to allocate to each crop so as to maximize his profit.

## The Worksheet

The worksheet has two sections:

- 1) A section where we enter the data, the adjustables, constraints, randoms, and the objective function for the problem. This is similar to the section that we create for solving a deterministic optimization problem.
- 2) A section where we enter the stochastic information.

Information can be entered directly onto the spreadsheet or via the set of dialog boxes.

### Step 1 (core model):

#### 1 Data and Formulas

Specify the quantity required, plantation cost, selling price and cost price for all the four crops. Also specify the total area of the farm.

Enter the formulas associated with the plantation and purchase cost, and amount from selling.

#### 2 Adjustable Cells

For each crop, the adjustable cells correspond to the following:

- a) Area Allocated
- b) Quantity Harvested
- c) Quantity Purchased

#### 3 Objective Function

The objective function is the profit given by:

Profit = Amount obtained from Selling the Excess Crop - Planting Cost - Purchase Cost

#### 4 Constraint Cells

a) For each crop  $c$ , the quantity of crop purchased plus the product of the yield and the area allocated to that crop is equal to the quantity sold and required.

i.e.  $\text{Quantity}(c) \text{ Harvested} + \text{Purchased} = \text{Quantity Sold} + \text{Required}$   
where  $\text{Quantity Harvested} = \text{Area Allocated} * \text{Random Yield per Acre}$

b) The sum of the areas allocated to all the crops should be less than or equal to the 'total area' of the farm.

i.e.  $\text{sum}(\text{area}(c)) \leq \text{total area}$

---

5 Random Parameters

Finally the 'Yield per Acre' cells will be read as random parameters.

**Step 2 (stochastic information for stage):**Initial Decision Variables

Specify the Area Allocated to each crop as an initial variable. This is done by using the function WBSP\_VAR. This function requires two parameters:

- i) stage of the variable
- ii) cell address of the variable

In this problem, the Area Allocated to each crop is an adjustable that has to occur at stage 0.

Random Parameters

Enter the yield information for all the crops under the various weather scenarios.

Then declare the Yields of each crop as a random variable. This is done by using the function WBSP\_RAND. This function requires two parameters:

- i) stage of the variable
- ii) cell address of the variable

In this problem, the Yields per Acre of the crop are the random variables that are realized at stage 1.

Stage Information for Recourse Variables

Declare the stage information for each recourse variables.

The following variables (adjustables) are assigned a stage 1 using the function WBSP\_VAR:

- a) Quantity Sold
- b) Quantity Purchased

The stage is 1 because these variables depend on the random variables and therefore take a value only at stage 1.

Stage Information for the Constraints and the Objective Function

The What'sBest! interface will automatically assign the objective function and all the constraints at stage 1, which depend on the stage value of the previous variables.

The user can also assign these variables to a stage 1, using the WBSP\_VAR function.

-

**Step 3 (distribution information for the random parameters):**

Declare a joint discrete distribution for the yields of the various crops. This is done by using the function `W BSP_DIST_DISCRETE_SV`. This function takes in two parameters:

- i) the set of possible values of the random variable (set vertically)
- ii) the cell address of the random variable

**Step 4 (scenario information):**

Specify the scenario information by using the function `W BSP_STSC`. This function requires a two-column table as an argument:

- 1) Column 1 for the number of stages in ascending order
- 2) Column 2 for the respective number of scenarios

In this problem, the number of stages is 1 and the number of scenarios is 4.

**Step 5 (reporting cells, histogram):**

Use the function `W BSP_REP`, and eventually the `W BSP_HIST`, to specify the cells that you wish to report. This Reporting function takes in one parameter that is the address of the cell that we wish to report in the final solution. The Histogram function will need the number of bins to display the appropriate table, which can be calculated automatically.

Here we are reporting the area allocated to each crop and the yields for the various crops, and the histogram for the objective cell.

**Scenario Tree:**

The Scenario Tree illustrates the concept of modeling under uncertainty.

- In Stage 0, the allocated area has to be decided for each crop to grow.  
In Stage 1, the crop yield is revealed depending on the weather, and as a recourse decision, the
  - quantity to produce, sell, and purchase, have to be decided.
  - The objective is to maximize the total expected profit at the end of planning horizon (Stage 1).
-

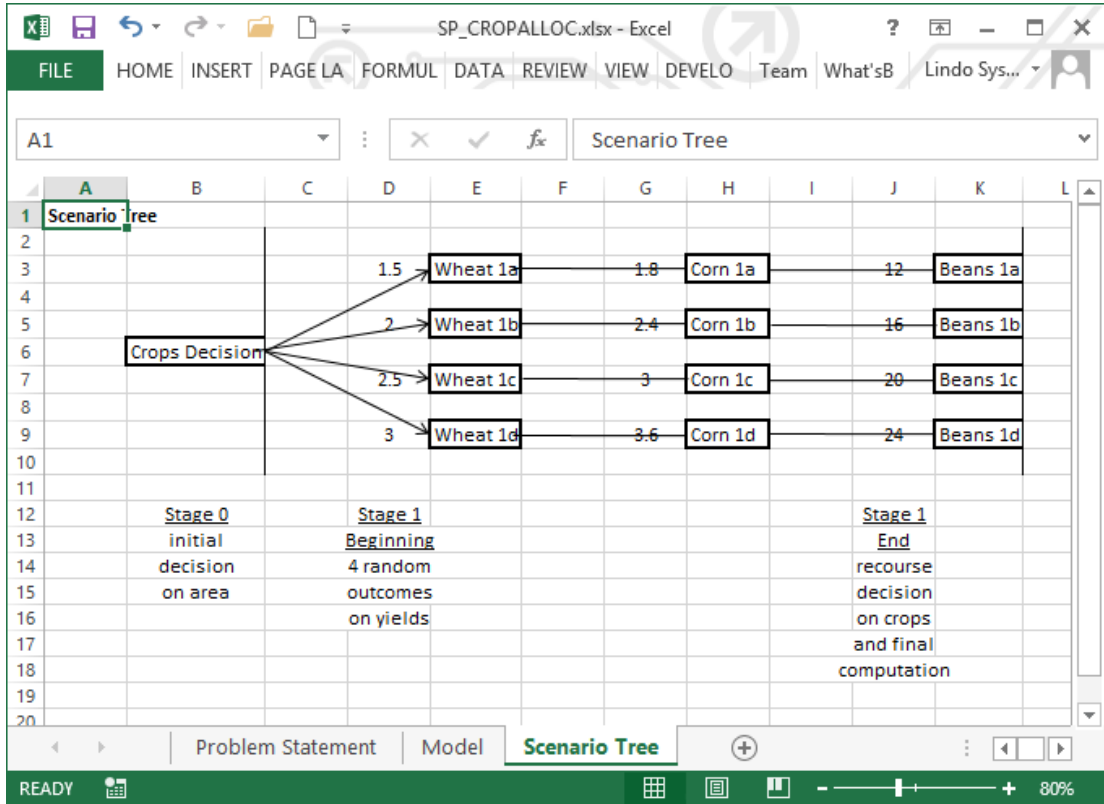

Optimization

The SP\_CROPALLOC Worksheet Before Optimization:

The screenshot shows an Excel spreadsheet with the following data:

Crops	Quantity Required	Planting Cost/Acre	Selling Price/Unit for Excess	Cost/Unit, Shortfall/Bought	Yield/Acre (random)
Wheat	200	150	170	238	3
Corn	240	230	150	210	3.6
Beans	100	260	200	270	24

Crops	Area Allocated	Quantity Harvested	Quantity Sold	Purchased
Wheat	0	0	0	0
Corn	0	0	0	0
Beans	0	0	0	0

**Objective:** Maximize Profit = Amount Obtained from Selling - Planting Cost - Purchase Cost

The SP\_CROPALLOC Worksheet After Optimization:

The screenshot shows an Excel spreadsheet with the following data:

Crops	Quantity Required	Planting Cost/Acre	Selling Price/Unit for Excess	Cost/Unit, Shortfall/Bought	Yield/Acre (random)
Wheat	200	150	170	238	3
Corn	240	230	150	210	3.6
Beans	100	260	200	270	24
Total Area	500				

Crops	Area Allocated	Quantity Harvested	Quantity Sold	Purchased
Wheat	0	0	0	200
Corn	0	0	0	240
Beans	500	12000	11900	0

**Objective:** Maximize Profit = Amount Obtained from Selling - Planting Cost - Purchase Cost

The solver writes a series of solution in the created tab 'WB!\_Stochastic' with the expected value, and displays the first scenario on the spreadsheet.

# Put Option

File name: SP\_PUTOPTION.XLSX

TYPE: NONLINEAR OPTIMIZATION -  
STOCHASTIC

## Application Profile

The holder of an American put option has the right to sell a specified stock at any time (the American feature) between now and a specified expiration date at a specified strike price. The holder makes a profit in the period of exercise if the strike price exceeds the market price of the stock at the time of sale. Wealth is invested at the risk free rate, and the stock return for a specific period is the uncertain parameter.

This is a multi-period stochastic problem under the uncertainty of a stock return.

## The Problem in Words

A trader of an American style option has the right to sell a stock.

There is an initial price of the stock of \$100, a strike price of \$99, a risk free rate of 4%. The trader can sell this stock over a 5 time period.

Given all prices, at the beginning of stage  $n$ , the market makes a random outcome. At the end of stage  $n$ , having seen all of market's  $n$  previous outcomes, as well as all the previous decisions, the trader makes the next decision.

The trader has to decide when to decide to sell it once so to generate a profit.

## The Worksheet

The worksheet has two sections:

- 1) A section where we enter the data, the adjustables, the randoms, the constraint, and the objective function for the problem. This is similar to the section for solving a deterministic optimization problem.
- 2) A section where we enter the stochastic information. Information can be entered directly onto the spreadsheet or via the set of dialog boxes.

### Step 1 (core model)

#### 1 Data and Formulas

Specify the initial price (\$100), the strike price (\$99), and the risk free rate (5%).

The price stock of this period = price of the previous period \* (1 + the stock return of this period). This is written in the cells C18 to C23.

The wealth of this period = the wealth of the previous period \* (1 + the risk free rate) + the decision to sell \* (strike price - price stock of this period). This is written in cells E18 to E23.



2 Adjustable Cell

There are 6 adjustable cells in cells E18 to E23, one for each period. The meaning is 1 for selling, 0 for holding.

3 Objective Function

The objective function is to maximize the wealth at the end of period 5, cell E28.

4 Constraint Cell

There is one constraints in D26 of the model. The total number of selling decisions has to be one.

5 Random Cell

There are 5 random parameters, in cells B19 to B23, one at each period, expressing the uncertainty of the stock return.

**Step 2 (stochastic information for stage):**Decision Variables

Specify the stage information for the decision to sell or to hold, which is a decision variable (adjustable). This is done by using the function `WBSP_VAR`. This function requires two parameters:

- i) stage of the variable
- ii) cell address of the variable

In this problem, the decision in cell D18 is a recourse variable that has to be decided at stage 0:  
`=WBSP_VAR(0,D18)`

Then the other adjustables belong to their respective period. For instance, D23 belongs to the stage 5.

Random Parameters

Specify the stage information for the stock return. This is done by using the function `WBSP_RAND`. This function requires two parameters:

- i) stage of the variable
- ii) cell address of the parameter

In this problem, the return in cell B19 occurs randomly at stage 1:  
`=WBSP_RAND(1,B19)`

Then, the random cell in B23 occurs at stage 5.

---

Other Variables

The *What'sBest!* interface will automatically assign the objective function and all the constraints at stage 1, which depend on the stage value of the previous variables. The user can also assign these variables to a stage 1, using the `W BSP_VAR` function.

For instance, the following variables are assigned a stage 1, because they are dependent of the random parameter which is at stage 1.

- a) Price of stock this period (cell C19)
- b) Wealth this period (cell E19)

It would have been possible to define these variables for taking a value only at stage 1:

`=W BSP_VAR(1,C19,D19,E19)`

Also, the constraint in D26 belongs to stage 5.

---

**Step 3 (distribution information for the random parameters):**

Specify a discrete distribution for the stock return parameter. This is done by using the function `WBSP_DIST_DISCRETE_SV`. This function takes in two parameters:

- i) the set of possible discrete values for the scenarios (set vertically)
- ii) the cell address of the random parameter

The random demand in cell B19 will take the values entered in the range S19:S22, with equal probabilities:

```
=WBSP_DIST_DISCRETE_SV($S$19:$S$22,B19)
```

**Step 4 (scenario information):**

Specify the number of scenarios per stage by using the function `WBSP_STSC`. This function requires a two-column table as an argument:

- 1) Column 1 for the number of stages in ascending order
- 2) Column 2 for the respective number of scenarios

In this problem, there are 5 stages, with 2 scenarios each, set in the range J28:K32:

```
=WBSP_STSC(J28:K32)
```

It happens the discrete table for the distribution has only 4 possible values, so the random parameters will select 2 among the 4 outcomes with replacement. The option "Sampling on Continuous Only" needs to be turned off to take advantage of the sampling feature.

**Step 5 (reporting cells):**

Use the function `WBSP_REP` to specify the cells that should appear in the Stochastic report. This function takes a series of arguments that are the address of the cells that should be reported in the final solution:

```
=WBSP_REP(C19:C23,D18:D23,Wlth0,Wlth1,Wlth2,Wlth3,Wlth4,Wlth5)
```

Here the stochastic report will display the outcomes of scenarios for all the random cells, the price of stocks for any periods, the decision to sell, and the ending wealth to maximize.

Use the function `WBSP_HIST` to generate a histogram of the Present Value, in a 8-bin graph:

```
=WBSP_HIST(8,E28)
```

**Scenario Tree**

The Scenario Tree illustrates the concept of modeling under uncertainty.

In Stage 0, an initial decision has to be made for selling or keeping the stock.

In Stage 1, the stock return is revealed depending on the market wealth, and as a recourse decision, the sell or keep action has to be decided.

From Stage 2 to 4, the same sequence is applied.

In Stage 5, the stock return is revealed, a recourse decision is made, as well as the final computation.

The objective is to maximize the total expected profit at the end of planning horizon (Stage 5).

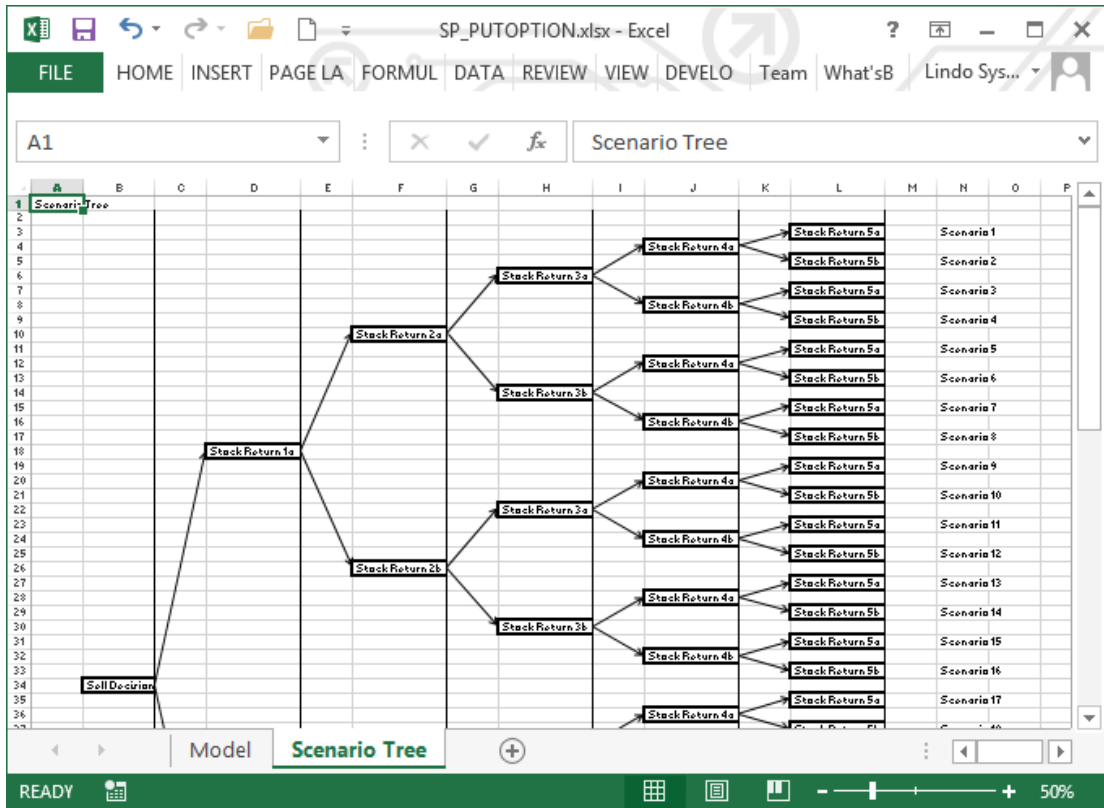

Optimization

The SP\_PUTOPTION Worksheet Before Optimization

The screenshot shows an Excel spreadsheet with the following content:

**Stochastic Programming Version of an American Put Option.**  
 The holder of the option has the right to sell a specified stock at any time (the American feature) between now and a specified expiration date at a specified strike price.  
 The holder makes a profit in the period of exercise if the strike price exceeds the market price of the stock at the time of sale. Money is borrowed/invested at the risk free rate.

**Step 1) Core/one-scenario model**

Initial Price=	100
Strike price=	99
Risk free rate=	0.03

**Step 2) Stage information**

Period	Stock return this period	Price of stock this period	Wealth this period	Sell ?(1)
0	0	100.000	0	0.000
1	-0.08	92.000	0	0.000
2	-0.01	91.080	0	0.000
3	-0.01	90.169	0	0.000
4	-0.01	89.268	0	0.000
5	0.03	91.946	0	0.000

**Step 4) Sample sizes**

Stage	Scenario
1	4

**Stochastic Extension**

Specify stage of Sell decisions	Mark Stock as random and give st
WBSP_VAR	WBSP_RAND
WBSP_VAR	WBSP_RAND
WBSP_VAR	WBSP_RAND
WBSP_VAR	WBSP_RAND
WBSP_VAR	WBSP_RAND
WBSP_VAR	WBSP_RAND

Number times sold: 0  
 Can sell at most once: <= 1  
 PV of final wealth: 0 <=Maximize

Model Scenario Tree

READY 70%

SP\_PUTOPTION.xlsx - Excel

FILE HOME INSERT PAGE LA FORMUL DATA REVIEW VIEW DEVELO Team What'sB Lindo Sys...

A1

Stochastic Extension			
Step 2) Stage information			
Specify stage of Sell decisions	Mark Stock returns as random parameters and give stage	Step 3) Distribution of possible returns on stock	Distribution table
WBSP_VAR	WBSP_RAND	WBSP_DIST_DISCRETE_SV	0.09
WBSP_VAR	WBSP_RAND	WBSP_DIST_DISCRETE_SV	0.03
WBSP_VAR	WBSP_RAND	WBSP_DIST_DISCRETE_SV	-0.01
WBSP_VAR	WBSP_RAND	WBSP_DIST_DISCRETE_SV	-0.08
WBSP_VAR	WBSP_RAND	WBSP_DIST_DISCRETE_SV	
Step 4) Sample sizes		Step 5) Reporting cells	
WBSP_STSC		Reporting Cells	
Stage	Scenario	WBSP_REP	Generate a histogram of the PV
1	4	WBSP_HIST	
2	4		
3	4		
4	4		
5	4		

Model Scenario Tree

READY 70%

The SP\_PUTOPTION Worksheet After Optimization

SP\_PUTOPTION.xlsx - Excel

FILE HOME INSERT PAGE LA FORMUL DATA REVIEW VIEW DEVELO Team What'sB Lindo Sys...

A1 : What'sBest!® 13.0.0.0 (Sep 30, 2014) - Lib. 9.0.1889.103 - 64-bit

1 What'sBest!® 13.0.0.0 (Sep 30, 2014) - Lib. 9.0.1889.103 - 64-bit - Stochasti

2

3 DATE GENERATED: Oct 14, 2014 10:01 AM

4

5

6 STOCHASTIC INFORMATION:

7

CLASSIFICATION DATA	Current	Capacity Limits
Adjustables	20480	Unlimited
Integers/Binaries	0	Unlimited
Constraints	27650	Unlimited
Nonlinears	10240	Unlimited
RANDBMS	5	
STAGES	6	
NODES	1365	
SCENARIOS	1024	

18

19 Expected Value (EV) 3.45E+00

20 Expected Value of Perfect Information (=LEVMS-EV!) 1.66E+00

WB! Status WB! Stochastic WB! Histogram Model Sci ...

READY 90%

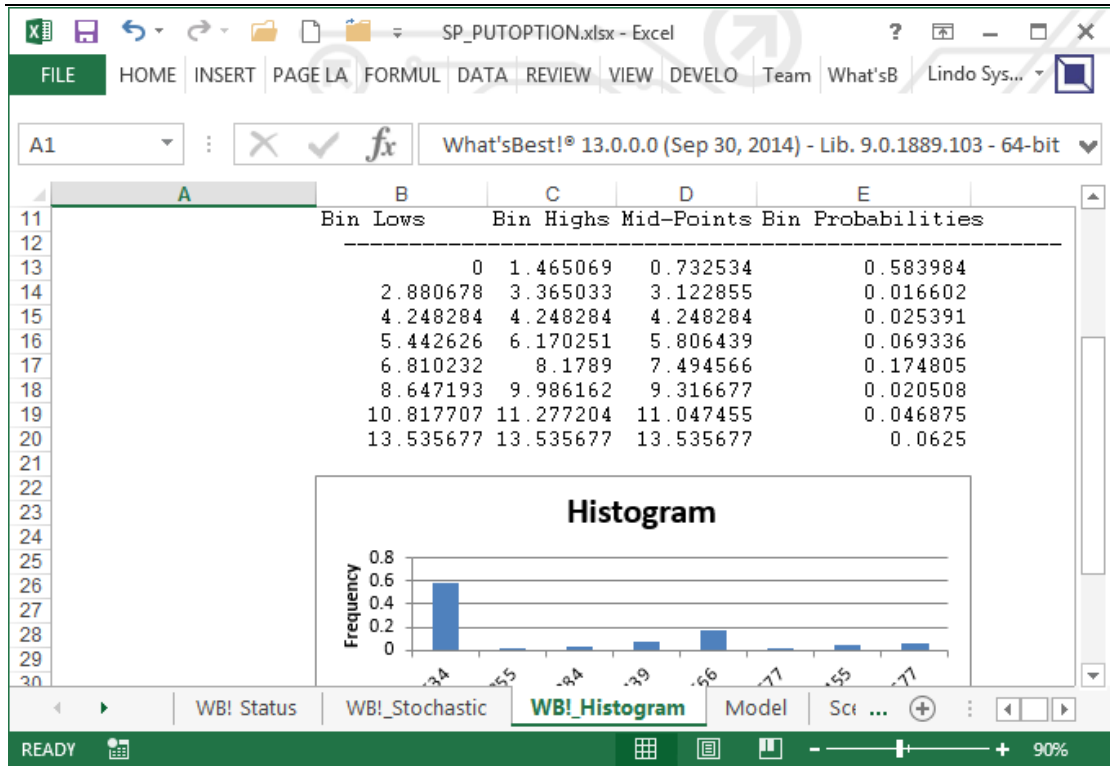

The solver writes a series of solution in the created tab '*WB!\_Stochastic*' with the expected value, and displays the first scenario on the spreadsheet.



---

# 8 Troubleshooting

---

Troubleshooting is divided into two major sections, *Frequently Asked Questions* and *Error Messages & Warnings*.

The *Frequently Asked Questions and General Operational Problems* section lists general problems and symptoms that may occur due to some operational problem, especially in loading and running What'sBest! within Excel®. This can be reviewed as a Technical Support.

Error Messages & Warnings is a list of messages that may be encountered in building and solving a model. Most of these messages are returned in the WB! Status report.

The Appendix section gives additional information on the installation process.

If you encounter an error message that is not discussed here, please contact LINDO Systems.

---

## FAQ Frequently Asked Questions

Frequent Questions and General Operating Problems.

### Content

- ◆ The solution returned from What'sBest! is not optimal (i.e., there is a solution that yields a better value in the best cell and satisfies all constraints).
- ◆ An Excel® error appears claiming that a workbook cannot be opened under High Security Level.
- ◆ An Excel® error appears referring to "multiple copies of WBA.XLA, WBA.XLAM".
- ◆ When I try to close Excel®, an error appears stating, "This workbook is currently referenced by another workbook and cannot be closed".
- ◆ The What'sBest! menu does not load.
- ◆ There are Excel® error codes of #REF! in What'sBest! cells.
- ◆ What are the system requirements to install What'sBest!?
- ◆ How do I install What'sBest! add-in on my computer?
- ◆ Where are the What'sBest! add-in files installed on my computer?
- ◆ What can I do if I receive an error message?
- ◆ Can I protect my workbook from viewing?
- ◆ How large can my model be?
- ◆ How do I fix the "Error Opening File" error message?
- ◆ How do I fix the "Error in Auto\_add: #=5: Invalid procedure or call argument" error message?
- ◆ How do I fix the "Error in returning solution in cell..." error message?
- ◆ When using Function Support, the system seems to hang with the message "Server Busy".
- ◆ What Excel® file format should be used?
- ◆ What 32-bit or 64-bit format should be installed?
- ◆ Error in Managing Temporary Files?

---

**The solution returned from What'sBest! is not optimal (i.e., there is a solution that yields a better value in the best cell and satisfies all constraints).**

**Problem:** The model may be incorrectly formulated or, with a nonlinear model, the returned solution may be a local optimum rather than a global optimum.

**Suggestions:** The following actions may help you in checking your formulation and/or improving the solution returned by What'sBest!:

- ◆ Use the Warnings feature to enable all warning messages (set via Options...|General) and re-solve the model. Check the returned status report for any indication of a problem. A warning you consider trivial may be a sign of a more serious underlying problem.
- ◆ Look at all of the constraints in the model to ensure that each was formulated properly, all cell references are correct, and their signs ( $\leq$ ,  $\geq$ , and  $=$ ) are correct.
- ◆ If you are using the Omit feature, carefully check the contents of each omitted range. For information on the Omit feature, see the section entitled Advanced...|Omit.
- ◆ If you know of a better solution than the one returned by What'sBest!, input the new adjustable cell values and check that all the constraints are satisfied and the best cell has improved.
- ◆ If the model contains nonlinear relationships (check the model statistics in the status report), consider re-solving the model with different starting values for the adjustable cells. Also, check the scaling and consider tightening the bounds on your adjustable cells. The section entitled Guidelines for Modeling with What'sBest! in Overview of Mathematical Modeling may be helpful in building better nonlinear models.

---

**An Excel® error appears claiming that a workbook cannot be opened under *High Security Level*.**

**Problem:** This error occurs when Excel® tries to open the What'sBest! add-in. What'sBest! makes use of Excel® macros to implement the `=WB()` constraint function.

**Suggestions:** The safest option is to put Excel® into *Medium* security mode. To do this, run the `Tools|Macro|Security` command in Excel® and set the *Security Level* to *Medium*. The problem with this approach is that you will be prompted by Excel® each time it loads as to whether or not you wish to allow the What'sBest! add-in to be loaded. An alternative is to run the `Tools|Macro|Security` command, select the *Trusted Sources* tab, then check the *Trust all installed add-ins and templates* button.

---

**An Excel® error appears referring to "multiple copies of *WBA.XLA*, *WBA.XLAM*".**

**Problem:** You have a toolbar left from a previous version of What'sBest!, which must be deleted before you reinstall What'sBest!.

**Suggestions:** First, uninstall What'sBest! from your machine with the Uninstall program. You can search for the word "uninstall" to find a shortcut entitled "uninstall What'sBest!", and double-click it. Otherwise, you can manually remove What'sBest! related files from your machine. The location of the What'sBest! files is indicated at the bottom of the *About What'sBest!* dialog box. Then, to delete the old toolbar, use the `View|Toolbars|Customize...` (Excel® 2002) command to bring up a list of the available toolbars, or right click on the ribbon to select Delete (Excel® 2007). Scroll down to the What'sBest! toolbar, which may or may not be checked off, and click on (highlight) the words

---

---

"What'sBest!". Then, click the *Delete* button to remove the old toolbar. Now, install What'sBest! and the new toolbar will be installed without conflict with the old toolbar.

---

**When I try to close Excel®, an error appears stating, "This workbook is currently referenced by another workbook and cannot be closed".**

**Problem:** You have set a reference to *WBA.XLA* or *WBA.XLAM* in the VBA Editor that must be removed before the What'sBest! add-in can be removed and Excel® can close.

**Suggestions:** From the Visual Basic® Editor (*Tools|Macro|Visual Basic Editor*) go to *Tools|References* to open the list of references. Unselect *WBA.XLA* or *WBA.XLAM* and you should be able to close Excel®.

---

**The What'sBest! menu does not load.**

**Problem:** The add-in is not set to load or there is a conflict such that it is unable to load.

**Suggestions:** In Excel®, to set the What'sBest! add-in to load, choose *Tools|Add-ins* from the Excel® menu and select What'sBest! from the list of add-ins. If What'sBest! is not in the list, press the *Browse* button to locate the What'sBest! add-in file, *WBA.XLA* or *WBA.XLAM*, so it can be loaded. The default location for it is the *Library* subdirectory below the *Excel®* directory. If it is not there, it will probably be found in the *WB* subdirectory.

If you have a laptop machine and are running Excel®, it is possible that the files required to support add-ins have not been installed. If the *WB!* menu item does not appear on the menu after trying to set the What'sBest! add-in to load, run the installation program for Excel® and choose the *Typical* installation option when prompted.

---

**There are Excel® error codes of #REF! in What'sBest! cells.**

**Problem:** The What'sBest! add-in provides special functions to Excel®, giving it the ability to express constraints and dual cells. As it does with all add-in functions, Excel® internally stores the location of the add-in program files whenever you use one of the What'sBest! add-in functions in a model. As a result, if you create a model with What'sBest! add-in functions and later open it using a copy of Excel® that has the What'sBest! program files installed in a different location, then Excel® will not properly handle the What'sBest! functions, and displays the #REF! error code.

**Suggestions:** Close the workbook and then reopen it using the following procedure. When Excel® opens the workbook and detects formulas with incorrect paths to your What'sBest! add-in, it will present you with a message about automatic links and then ask: "Do you want to update all linked information?". Answer "Yes" and use the *Browse* button to find the *WBA.XLA* or *WBA.XLAM* file in your *LIBRARY* subdirectory of your main Excel® directory. If this does not remove the #REF! error, then use the What'sBest! *Update Links* button on the *General Options* dialog box. This should correctly update the path. If you fail to update the links with the What'sBest! *Update Links* button, then Excel® will place the error code of #REF! into the cells with the incorrect path to *WBA.XLA*, or *WBA.XLAM*.

If you frequently exchange models with other What'sBest! users that have their program files in a different location, or you have updated or re-installed the What'sBest! program files in a different location, please refer to the discussion of the *Update Links* button under *Options...|General*.

---

**What are the system requirements to install What'sBest! ?**

To install and run What'sBest!, check that you have the following:

Software

- ◆ Microsoft® Windows® 7, 8, or Windows® XP, Vista®
- ◆ Microsoft® Excel® 32-bit version 2002 or higher, version 2007, 2010, 2013
- ◆ or Microsoft® Excel® 64-bit version 2010, 2013 with latest Service Packs
- ◆ Microsoft® .NET Framework 4.0

Hardware

- ◆ Pentium-class PC
- ◆ 500 MB of RAM
- ◆ 50 MB of free disk space

Make sure you have administrative privileges to install files on your default drive, System, and Program Files folders.

An Internet connection is required to download the latest version of What'sBest!. You can also contact LINDO Systems to obtain a copy. Additional information can be found via the *Help* command on the What'sBest! menu.

---

**How do I install What'sBest! add-in on my computer?**

If you are installing What'sBest! from the original CD, open the What'sBest! folder click on 'setup.exe'. If you downloaded the demonstration version from the website, simply run the executable or unzip the zip file and then run the executable. Excel® should be closed during the install process. An installation program will then commence and will verify if What'sBest! has already been installed. If it has, you will be asked you if you would like to remove the previous version or to write-over it. In the next step, you will be presented with the standard license agreement for What'sBest!, which you must agree to. What'sBest! will then confirm that your system requirements are adequate. If so, you will then choose a destination directory for the What'sBest! sample files.

Next, you will be given a choice between a *Default* and a *Specified* setup for the add-in files. The Default setup is recommended for English language versions of Windows®. This will install the What'sBest! add-in files in Excel®'s *Library folder*. *On the other hand, should you choose the Specified setup, the add-in files will be installed in a directory that you specify. The Specified option is recommended for non-English versions of Windows®, or network installations.*

At this point, What'sBest! has enough information to begin copying files. Once the files are done copying, a *Finish* button should appear. After clicking *Finish*, Excel® will open. You may receive a message that 'wbintr.xls contains macros'. You must then select the *Enable Macros* button in order to finish installation.

---

**Where are the What'sBest! add-in files installed in my computer?**

The *Default* installation will automatically transfer the program files to the *Library* subdirectory of your main Excel® directory, usually *C:\Program Files\Microsoft Office\Office10\Library\LINDOWB* for Excel® 2002, or in *C:\Program Files\Microsoft Office\Office14\Library\LINDOWB* for Excel® 2010.

---

You should find the following files:

CONOPTx.DLL  
LIBIOMP5MD.DLL  
LINDOx\_0.DLL  
LINDOCU\_xx.DLL  
LINDOPRx.DLL  
LINDOWBEF.DLL  
LINDOWBIL.DLL  
LNDWBxxx.LIC  
MOSEKx\_0.DLL  
MXST32.LIB  
README.WRI  
VCREDIST\_x86.EXE  
WBA.XLA (Excel® 2003) or WBA.XLAM (Excel® 2007 and later)  
WBINTR.XLS  
WBOPT.DLL  
WBOPTLINK.EXE  
WBUNCHADD.EXE

The Help file will be stored in the same directory:

LINDOWBHELP.CHM

Finally, sample workbooks will be installed in *C:\WB*.

The *Specified* installation differs from the *Default* installation in that it lets you choose the specific location for the What'sBest! add-in files.

The 64-bit files are identified with the '64' inside the file name.

---

### What can I do if I receive an error message?

What'sBest! displays two kinds of error messages: those generated by Excel® and those generated by What'sBest! itself.

Errors from Excel® (e.g., "Illegal Operation" or "Runtime Error") typically result from operational problems in the loading and running of What'sBest!. You should check that your model is pointing to the right What'sBest! add-in file and that there is no loss of links. To do this, check the *Tools|Add-ins* list and *Browse* to find What'sBest!. If you are developing macros with the Visual Basic® Editor and using What'sBest! functions, verify that the *Tools|References* command is referring to the correct *WBA.XLA* file. In Excel® 2007, go to the *OfficeButton|ExcelOptions|Add-Ins|Go*, to browse to the correct location.

What'sBest! generated errors (e.g., "Error building the model") are typically encountered when building and solving a model. Check to see that all adjustable, best, and constraint cells are correctly specified. Also, if you have moved your model from one computer to another, try running the *General...|Options...* command and clicking the *Update Links* button. You may also not nest any What'sBest! functions in a single expression.

---

### Can I protect my workbook from viewing?

You can password protect worksheets, data, and macros from viewing. However, you may not protect any of the adjustable, dual or range cells. What'sBest! will still be able to solve the model, but it won't be able to access these protected cells in order to write the results.

---

**How large can my model be?**

The size model you can solve will depend primarily on the size license you purchased. For a list of the various sizes and their specific limitations see section *About What'sBest!*.

*Other indirect limitations are memory and time. Your model may physically fit within the limits of your version of What'sBest!, but, particularly for very large models, there may not be enough random access memory available to successfully solve your model. Also, certain classes of models are very difficult to solve. A tough model may take more time to solve than you are willing to wait. For more information on what makes a model tough and techniques for making models easier to solve, refer to the section *Overview of Mathematical Modeling*.*

---

**How do I fix the "Error Opening File" error message?**

This error message results from temporary files that couldn't be closed from the last run of the What'sBest! Solver.

Go to the folder where your model file is located and remove any What'sBest! temporary files. These files are named:

LINDOWBS.XLS  
LINDOWBX.XLS  
LINDOWBS.XLSB  
LINDOWBX  
LINDOWBRC.TXT  
LINDOWBSOLN.TXT  
LINDOWBSTATUS.PRN  
LINDOWBSOLN.PRN  
LINDOWBSTOC.PRN  
LINDOWBSTOH.PRN  
LINDOWKBST.PRN

---

**How do I fix the "Error in Auto\_add: #=5: Invalid procedure or call argument" error message?**

This error will appear when an Excel® function or VBA statement cannot be executed properly. In the case of What'sBest!, this is typically due to missing program components. Attempting to attach the What'sBest! add-ins over a network can lead to this problem in that not all of the What'sBest! add-in files will get copied to the local machine. For this reason, we recommend installing What'sBest! on every platform you intend to use it on. Running a complete install on each machine will guarantee that all the correct add-in files are copied to the correct folder.

---

**How do I fix the "Error in returning solution in cell..." error message?**

Usually, this error appears when What'sBest! could not access the worksheet in order to copy the solution back to the adjustable cells, or the temporary solution file could not be read. First, verify that your worksheet is not protected or locked. Also, make sure Excel® is calling the right add-in in the *Library* folder.

---

**When using Function Support, the system seems to hang with the message "Server Busy".**

Usually, this Windows® message appears when a Microsoft® Office® component could not access the add-in in order to read it and to execute it.

---

If your add-in has been digitally signed, you will need to enable this add-in to run your model, then retry the call. In some situations, a time delay may occur after enabling the add-in. Also, make sure Excel® is calling the add-in in the right folder.

In Excel® 2002, there is an additional security setting that the user needs to set for accessing and executing a macro from the Solver. Select 'Trust Access to Visual Basic Project' via the 'Tools|Options|Security|MacroSecurity|TrustedSources' menu. Then save the model and restart Excel®.

In Excel® 2007, this feature can be set via the OfficeButton|ExcelOptions|TrustCenter|TrustCenterSettings.

---

### What Excel® file format should be used?

In Excel® 97-2003, the file format is ".XLS" with a maximum size of 256 columns and 65536 rows per sheet.

Starting Excel® version 2007, the new format is either ".XLSX", ".XLSB" for workbook, or ".XLSM" for macro-enabled workbook, with a maximum size of 16384 columns and 1048576 rows per sheet. You can save your file with any of these formats.

---

### What 32-bit or 64-bit format should be installed?

*What'sBest!* depends on the bit format of Excel®, not Windows®. The bit format is clearly indicated via the File-Help menu of Excel®. For instance, you may have installed a 32-bit format of Excel® on a 64-bit version of Windows®. In this case, you should install a 32-bit *What'sBest!*.

*What'sBest!* 64-bit should be installed with Excel® 64-bit, on a 64-bit operating system. Otherwise, install the 32-bit version of *What'sBest!*.

The Installation topic in the Appendix section shows additional settings to verify in Excel® for running an add-in.

---

### Error in Managing Temporary Files?

There is a topic named TEMPFILE for the "Error Managing Temporary Files" message in this section. *What'sBest!* needs to create temporary files for building data listing, and returning solutions or reports. Such message implies a non access to the folder or its files: network location without mapping a drive, a file format .XLSX without the Microsoft® .NET Framework library in the system, a wrong 32 or 64-bit installation, or missing user's privileges.

The user may just try a sample file in the "C:\WB" folder.

Being able to run a .XLS file but not a .XLSX means your system is missing the .NET Framework, in which situation you can run a Windows® Update to download it.

Also, you can verify the access rights then moving the model file in this same "C:\WB" location. This simple location will be accessed by *What'sBest!*. In some situations, you can map your network location via the Windows® Explorer, then open the file from there.

Finally, another instance of Excel may still be running as a back task, then your model file handler will still be on hold. This eventually happens if you run a large file via a macro loop in VBA code.

---

## Error Messages & Warnings

If What'sBest! encountered an error during the solution process, then it opens the status report worksheet tab entitled *WB! Status*, as opposed to the worksheet that was open before the run. Based upon the error message returned, you can troubleshoot your model. The default setting for the *General Options* dialog box (*Options...|General*) is to produce a status report following each solve command.

Most of the following errors will be found in the status report worksheet after the model is solved.

---

## Errors from VBA Code

Excel® generates these error messages when the *WBA.XLA* file has not been checked off as a reference add-in for your calls to the What'sBest! VBA interface. To ensure the What'sBest! procedures are available to your Visual Basic® code, choose *Tools|References...* from the Visual Basic® Editor and make sure *WBA.XLA* is checked.

**Note:** The first step in running What'sBest! from VBA is to create a reference to What'sBest!. This reference is made by checking the *WBA.XLA* box under *Tools|References* from within the *Visual Basic® Editor* (The *Visual Basic® Editor* is called via *Tools|Macros* from the main Excel® menu bar). If you do not create this reference, then any attempt to use the What'sBest! attributes or procedures will produce the error message *Sub or Function not defined*.

---



## Runtime Errors

If you did not place error handling into your VBA code, then Excel® handles a *What'sBest!* error by generating a run-time error message box.

In many instances, this runtime error message provides you with a *What'sBest!* error code (a number over 30000). However, in some cases you may only receive a *Run-time error 5: Invalid Procedure Call or Argument* message box like the one shown below. Whether you receive a *What'sBest!* error code or an Excel® error code, you must take steps to 1) correct the source of this error; and 2) insert error handling into your code to anticipate any further errors.

Error handling is placed in your VBA code by adding a suitable *On Error* statement before any calls to *What'sBest!* routines and inserting some appropriate error handling code. Including error handling in your code will prevent Excel® runtime error messages like that shown above. For an example of such code, see the section entitled *wbError and Error Codes* in chapter *VBA Interface*.

If you don't correct the source of the error, fail to insert error handling, and you again run the routine that produced the error, then Excel® will generate the following, cryptic error message:

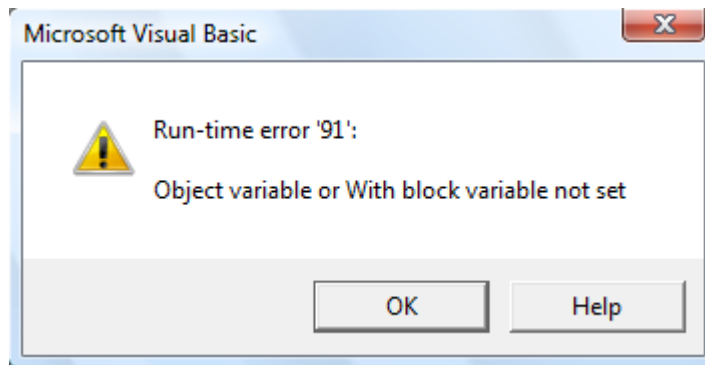

This message signifies that Excel® has an unhandled error left over from the previous run and cannot display the new error that was just generated. You must now try to correct the source of the error, but this time you do not have the benefit of a *What'sBest!* error code. If you can't manage to guess what the source of the error is, then you must resort to unchecking the *What'sBest!* add-in from the list generated by the *Tools|Add-ins* command. This forces the removal of the previous unhandled error. Now, you can return to the add-in list and check the *What'sBest!* add-in to reinstate it. You now have another chance to determine the source of the error and insert error handling code.

### *Errors from an embedded application*

In the case of an error running *What'sBest!* embedded within a Visual Basic® project, the *Run-time error 5: Invalid Procedure Call or Argument* message box shown above will be displayed. This may be followed by a *Run-time error 440: Automation Error*. To correct this problem, you will need to terminate the application, insert appropriate error handling, and run the application again. The error handling for an embedded application is distinct from normal error handling for a stand-alone Excel® application. A code sample of this error handling is provided toward the end of the section entitled *wbError and Error Codes* in chapter *VBA Interface*.

---

## ***Invalid Outside Procedure***

This is often the result of using parenthesis without the CALL keyword in Visual Basic® code. Either put the keyword CALL in front of the procedure calls where you use parenthesis or remove the parenthesis.

---

## ***ADDINLINK - Multiple Add-in Links***

In the case of multiple installations of *What'sBest!*, the solver may be confused on the source link to the add-in. The following error message will be displayed on the *WB! Status* tab.

### **Error Message:**

\*\*\*ERROR\*\*\*

Multiple Add-in Links (Help reference: ADDINLINK):

The workbook contains multiple links to the *What'sBest* add-in. Only one source should be defined in the workbook. Make sure to correct the add-in link reference via the menu 'Edit|Links' or 'OfficeButton|Prepare|EditLinksToFiles' and remove the corrupted link. Then update the workbook links via the menu 'WB|Options|General|UpdateLinks', save the file, and reopen it.

### **Suggestions:**

Make sure of the location of the current add-in via the Excel® menu "Tools|Add-ins" or "OfficeButton|ExcelOptions|Add-Ins|Go". You may need to reset the add-in by browsing to the installation location.

Remove any corrupted or wrong add-in link from your workbook via the menu "Edit|Links" or "OfficeButton|Prepare|EditLinksToFiles".

Reset the links on the worksheet to the *What'sBest!* functions via the menu "WB!|Options|General|UpdateLinks".

Save the file, close Excel®, and reopen it.

---

---

## ARITHERR - Arithmetic Error

Many mathematical operations are not defined (e.g., division by zero). What'sBest! tries to avoid such errors, but this is not always possible. When an irresolvable numerical error occurs, the following error message will be displayed on the *WB! Status* tab.

### Error Message:

\*\*\*ERROR\*\*\*

*Arithmetic Error (Help Reference: ARITHERR)*

*What'sBest! encountered an undefined arithmetic operation in the cell listed below.*

*One example of an undefined arithmetic operation would be division by zero, but there are many others. Check the cell below to determine the source of the error.*

*You must either rewrite the formula or constrain the adjustable cells to avoid the error.*

*-cell address-*

### Suggestions:

Examples of undefined arithmetic operations are: division by zero, multiplying by a text string, and evaluating to a number larger than  $10^{30}$ . If the cells are unrelated to solving the model, include them in a *WBOMIT* range or delete them. Otherwise, change the initial values of the adjustable cells to move away from the undefined region. Also, consider rewriting the model in such a way that all formulas are defined over the entire domain of the adjustable cells.

---

## BLKCELL - Blank Cell Warning

If your model has references to blank cells, the following warning message will be displayed on the *WB! Status* tab.

### Warning Message:

\*\*\*WARNING\*\*\*

*Blank Cell Warning (Help Reference: BLKCELL):*

*Blank cells have been referenced in formulas. During the solution process, their values have been taken to be zero. This warning can be turned off via the*

*WB|Options|General menu. See cell list below.*

*(cell addresses listed at bottom of tab)*

### Suggestions:

You should verify that the blank cells being referenced were actually intended to be blank. If the model looks correct, then you may choose to disable this warning message using the *WB|Options|General* command.

---

---

## **ENTIRERANGE - Entire Range Selection**

In the situation where some of the formulas are selecting an entire column or row, the following warning message will be displayed on the *WB! Status* tab.

### **Warning Message:**

\*\*\*WARNING\*\*\*

*Entire Range Selection (Help Reference: ENTIRERANGE):*

*A function argument selects an entire column or row in a worksheet, for instance showing A:A or 1:1. This full selection creates several blank cells that may not be necessary to the model, then requesting extensive memory resources for the model, depending on the format of the file as .XLS or .XLSX. A correction would be to select the exact range or cells in the formula.  
-cell address-*

### **Suggestions:**

What'sBest! will create a 0-value number for any blank cell being referenced by a formula, thus memory allocation for the system. An entire column selected means 1048576 cells, and an entire row means 16384 cells in a .XLSX format. Similarly in a .XLS format, it means 65536 cells for a column, and 255 cells for a row. This warning message will not be displayed if the selection is shorter than these numbers.

---

## **EXLVER - Excel® File Format**

If your workbook is not saved in a current workbook file format, the following warning message will be displayed on the *WB! Status* tab.

### **Warning Message:**

\*\*\*WARNING\*\*\*

*Excel® File Format (Help Reference: EXLVER):*

*The file format you have chosen is from an older release of Excel®. Please resave your file using the latest Excel® file format*

### **Suggestions:**

What'sBest! requires workbooks to be saved in Excel® 97 format, or higher. You will need to work with a more current Excel® file format. Resave the file using the *File|Save As* command in Excel®. When presented with the file save dialog box, select a more current file format from the *Save as type* dropdown box.

---

---

## FORMULA1 - Formula Parsing

If What'sBest! was unable to parse a cell formula in your workbook, the following error message will be displayed on the *WB! Status* tab.

### Error Message:

\*\*\*ERROR\*\*\*

*Formula Parsing (Help Reference: FORMULA1):  
An error occurred while attempting to parse the cell formula listed below.  
Check the formula in this cell for potential problems such as complex  
nested functions or text strings as arguments. Some Excel® functions also  
require a specific format.  
-cell address-*

### Suggestions:

In rare instances, if a formula becomes too complex What'sBest! may not be able to successfully parse it. Things to check for are nested functions that are many layers deep, in which case, you may want to break the formula up into multiple cells. Another possibility is that you have used a text string as part of the formula. Finally, some Excel® functions must follow a specific format in order to be parsed by WB.

You may need to contact LINDO Systems for assistance.

---

## FORMULA2 - Unsupported Functions

What'sBest! does not directly support all the functions available in Excel®. If any unsupported functions references are found in any of the cell formulas, the following warning message will be displayed on the *WB! Status* tab.

### Warning Message:

\*\*\*WARNING\*\*\*

*Unsupported Functions (Help Reference: FORMULA2):  
The cells listed contain spreadsheet functions that are not defined in What'sBest!.  
The numeric values for these cells are taken from the spreadsheet directly  
without recalculation.  
(cell addresses listed at bottom of tab)*

### Suggestions:

Cells in your model can reference Excel® functions that are not supported by What'sBest!. However, these cells' values will be fixed at their calculated values at the start of the solve command. The list of cells referencing unsupported functions may be found at the end of the report. Supported functions and operators are listed in the *Supported Functions and Operations* section.

If the unsupported cells are used for reporting only, they can be included in a *WBOMIT* range (see the section entitled: *Advanced. . . |Omit*). If they are necessary to the actual optimization model, they must be expressed or approximated in terms of equivalent operations supported by What'sBest!. If you cannot approximate the unsupported functions, reformulate the problem to eliminate all such functions.

---

---

This warning may be disabled with the *Unsupported Function* warning checkbox in the *General Options* dialog box posted by the *Options...|General* command.

Using linked worksheets may also cause this message. For more on this subject, see the *Solve* topic".

---

## **FORMULA3 - External Reference**

If there are external links to other workbooks that can't be resolved, the following error message will be displayed on the *WB! Status* tab.

### **Error Message:**

\*\*\*ERROR\*\*\*

*External Reference (Help Reference: FORMULA3):*

*A link to an external workbook in the cell below could not be resolved. Check the validity of the link or remove the external link.*

*-cell address-*

### **Suggestions:**

An external reference was found that could not be imported. You should check to see if the link is valid and if it can be resolved.

Array formulas can also generate this error in that they may only reference native data contained in the primary workbook. If any of your array formulas have external links, you will need to import the external data into the native workbook.

---

---

## ***FUNCADDIN - Failed to Access the Add-in***

If the What'sBest! solver was unable to locate an add-in that is needed to calculate the user's defined functions, the following error message will be displayed on the pop-up window.

### **Error Message:**

\*\*\*WARNING\*\*\*

*Failed to Access the Add-in (Help Reference: FUNCADDIN):  
The workbook is referring to an add-in that is not at the  
specified location:  
(add-in location)  
This is needed to run the user's defined functions from  
Excel®. Reset any call to this add-in, then save the model  
and restart Excel®.*

### **Suggestions:**

Clear any Excel® call of this add-in via the menu "Tools|add-ins", reset the add-in by browsing to the right location, save the model, and restart Excel®.

In some situations, you may need to remove the add-in from your system to clean up any remaining link in the Excel® Add-ins list.

Also, you can carefully correct the link by accessing the registry editor from the Windows Start menu, then run "REGEDIT". Usually, the links are displayed in the registry folder "HKEY\_CURRENT\_USER – Software – Microsoft – Office – 10.0 – Excel – Options".

In Excel® 2007, adjust the security setting from the Excel® Options, then click on "Advanced|TrustCenter|TrustCenterSettings". Enable macros and grant the same access in the "Macro Settings" tab.

In case your add-in has been digitally signed, you will need to enable this add-in to run your model. In some situations, a time delay may occur after enabling the add-in.

Refer to the What'sBest! sample file *Shipping\_MacroFunctions.xls* for an example of valid user defined function usage.

---

## ***FUNCMACRO - Failed to Access the Macro***

If the What'sBest! solver is unable to execute a macro that is needed to calculate a user defined function, the following error message will be displayed on the pop-up window.

### **Error Message:**

\*\*\*WARNING\*\*\*

*Failed to Access the Macro (Help Reference: FUNCMACRO):  
The solver needs to access the VBA code to run the users' defined  
function from Excel®. Select 'Trust Access to Visual Basic Project'  
via the 'Tools|Macro|Security|TrustedSources' menu.  
Then save the model and restart Excel®.*

---

**Suggestions:**

In Excel® 2002, there is an additional security setting that the user needs to set for allowing the server to access a user defined macro. Select 'Trust Access to Visual Basic Project' via the 'Tools|Options|Security|MacroSecurity|TrustedSources' menu. Then save the model and restart Excel®.

In Excel® 2007, adjust the security setting from the Excel® Options, then click on "Advanced|TrustCenter|TrustCenterSettings". Enable macros and grant the same access in the "Macro Settings" tab.

In case your add-in has been digitally signed, you will need to enable this add-in to run your model. In some situations, a time delay may occur after enabling the add-in.

Refer to the What'sBest! sample file *Shipping\_MacroFunctions.xlsm* for an example of valid user defined function usage.

---

## ***FUNCSERVER - Failed to Access the Server***

If the What'sBest! solver was unable to access Excel® to calculate the user's defined functions, the following error message will be displayed on the pop-up window.

**Error Message:**

\*\*\*WARNING\*\*\*

*Failed to Access the Server (Help Reference: FUNCSERVER)  
The solver needs to access Excel® to run the users' defined functions. Make sure only one Excel® application is running, version 2002 or later, via the Task Manager. Also, verify that the application is not already busy with any macro virus scan.*

**Suggestions:**

The solver could not link into Excel® to execute the functions.

- Make sure to run Excel® version 2002 or later
  - Make sure Excel® is not already busy with another process
  - Turn off the virus scan for macro applications. In the mean time, select "Retry" from the "Server Busy" window.
-



---

## ***HIDSNAME - Hidden Solvers Names***

If the What'sBest! solver was able to detect hidden names coming from other solvers, and belonging to the workbook, the following message will be displayed on the pop-up window.

### **Message:**

*Convert Model Format*

*What'sBest! has found hidden names in this workbook related to non-What'sBest! model format.*

*Convert and Solve*

*Try to Solve without Conversion*

*Exit*

*Help*

*Where:*

- *'Convert and Solve' will convert these names into a What'sBest! format for the current selected worksheet, and try to solve. This will create What'sBest! style Adjustable, Best, and Constraint cells in the workbook.*

- *'Try to Solve without Conversion' will try to solve as a What'sBest! spreadsheet without conversion.*

- *'Exit' to cancel.*

- *'Help' to access the manual.*

*Notes:*

- You may remove these hidden names, or after conversion, via the menu:  
What 'sBest! -> Options -> Reset To Default.

- You can alternatively convert these names into What'sBest! format via the menu:  
What 'sBest! -> Advanced -> Convert Model Format.

For further information, look up HIDSNAME tag in:  
What 'sBest! -> Help -> Index

---

**Error Message:**

\*\*\*WARNING\*\*\*

*Hidden Solvers Names (Help Reference: HIDSNAME):*

*There are hidden names in this workbook related to other model formats for solvers. The interface can convert these names into a What'sBest format, via the menu 'Advanced - Convert Model Format' for the current selected worksheet. This will create any additional Adjustable, Best, or Constraint cells to review. Otherwise, you may clean up these model names via the menu 'Options - Reset To Default'.*

**Suggestions:**

These hidden names belong to the workbook. They may have been created when the model was being built with other solvers. These names are not visible via the Name Manager, but can be detected. They usually refer to variables, constraints, and objective cells from multiple models in a same workbook. So select the sheet tab from which these names would be converted, or removed.

- You may clean up these hidden model names via the menu “Options – Reset To Default”.
- You can convert these names into a What'sBest! format, via the menu “Advanced – Convert Model Format”.

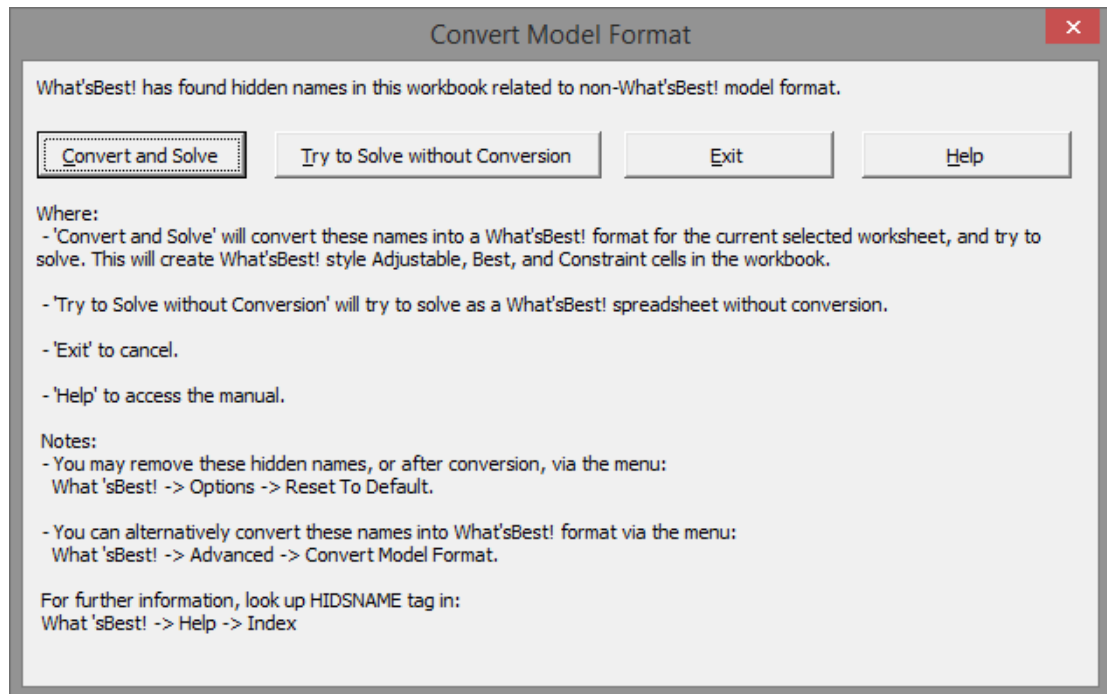

## ***IKBREP - K-Best WBIKB\_REP Format***

Using the K-Best feature, What'sBest! can return the trade-off solution information. Trade-off values tell you how sensitive the successive solutions are to various parts of the model. The =WBIKB\_REP() function is used to request trade-off values. If the arguments to this function are not correctly specified, the following error message will be displayed on the *WB! Status* tab.

**Error Message:**

\*\*\*ERROR\*\*\*

*K-Best WBIKB\_REP Format (Help Reference: IKBREP):*

*A WBIKB\_REP cell is incorrectly formatted. Correct the formula and the validity of the arguments in the cell below. The format should be '=WBIKB\_REP(cells)', where 'cells' must refer to variable cells.*

*-cell address-*

**Suggestions:**

There is an incorrectly formatted K-Best Report cell in the model. A reporting cell must use the format: =WBIKB\_REP(cells), where *cells* is a reference to the cells you want to report the trade-off value. The cell reference should be to a variable cell. For more information on using K-Best Solution values refer to section *Options...|Integer Solver*.

---

## ***INDICMOD - Indicator Model Cell Reference***

If your model has references to WB() constraint cells, without being in a Slack mode, the following warning message will be displayed on the *WB! Status* tab.

**Error Message:**

\*\*\*WARNING\*\*\*

*Indicator Mode Cell Reference (Help Reference: INDICMOD):*

*The following cells directly refer to WB constraint functions being in Indicator mode, rather than Slack mode. You need to modify the range selection, or to specify the Slack mode via the WB|Options|General menu (cell addresses listed at bottom of tab).*

**Suggestions:**

You should verify that the cells being referenced were actually intended to be in Slack, rather than Indicator mode, checking the option via the *WB!|Options|General* command. Otherwise, you may need to change the range selection in the cells listed at the bottom of the status report.

Some other What'sBest! functions, such as WBDUAL(), WBLLOWER(), or WBUPPER() for the dual values, can have references to WB() constraint cells without being in the Slack mode.

---

---

## ***INFEASIBLE - No Feasible Solution Found***

If the What'sBest! solver was unable to find a solution that satisfies all the constraints cells and any integer requirements in your model, the following error message will be displayed on the *WB! Status* tab.

### **Error Message:**

\*\*\*ERROR\*\*\*

*No Feasible Solution Found (Help Reference: INFEASIBLE)*

*There is no solution that satisfies all of the constraints and any integrality conditions in the model. Check to make sure all the constraints are properly formulated. Consider easing constraints in the returned model that are either not satisfied or tight. NOTE: The answer returned is not feasible, therefore the value of the objective function is NOT optimal. The solution returned is only for the purpose of illustrating a scenario with violated constraints so the model can be corrected. See the list of cells below that may be contributing to the infeasibilities.*

### **Suggestions:**

A linear optimization model containing constraints that cannot be satisfied simultaneously by What'sBest! is said to be infeasible. With nonlinear models, it's possible that a feasible solution exists, but What'sBest! was unable to identify that solution from the starting adjustable cell values you specified. In either case, the solver tries to find a solution to the problem that satisfies as many constraints as possible and returns the appropriate solution status in the status report worksheet entitled *WB! Status*.

If a linear or nonlinear problem is truly infeasible, correcting the model can be a very complicated task. The first step is to investigate those constraints contributing to the infeasibility. These cells have been identified for you by What'sBest! at the end of the *WB! Status* tab. If you have selected the constraint display type in *General Options* as *Indicator*, then the cells with unsatisfied constraints will display *Not =*, *Not <=*, or *Not >=*. Investigating their relationships to satisfied constraints may help you find the conflicts. Next, find all the constraints that are contradictory to the constraints identified in the first step. Finally, eliminate all the contradictory constraints except the ones that most accurately model your business situation.

If a nonlinear problem returns this error message and you suspect there is a feasible solution, change the starting adjustable cell values to a feasible or near-feasible solution and solve again. Note that a very discontinuous problem may have a feasible solution that can only be "found" by starting at the solution point itself.

If you have the global solver option, you may be able to use the multistart capability to automate the selection of alternate starting points. You may also try invoking the global solver, which, assuming the model is not too large, will always find a feasible point if one exists.

---

## INFLARG - Large Infeasibility

If the infeasibility is too large, the following warning message will be displayed on the *WB! Status* tab.

### Warning Message:

\*\*\*WARNING\*\*\*

*Infeasibility too large for a trusted solution (Help Reference: INFLARG)  
Constraint violations exceeding tolerances were found. Check the solution carefully before proceeding. You may be able to resolve this error by decreasing the Feasibility Tolerance in the General Options dialog, or by unchecking the Scale option in the Linear Option dialog box.*

### Suggestions:

What'sBest! calculates the amount by which all constraints are violated after the solver returns a solution. In general, this value will be quite small when a feasible or optimal solution is returned. In some cases the total violations, or infeasibilities, may be found to be excessive. When the total infeasibilities exceeds 0.01, What'sBest! will display this error. Under these conditions, you should check the solution carefully. You may be able to resolve this error by decreasing the Feasibility Tolerance in the *General Options* dialog, or by unchecking the Scale option in the *Linear Option* dialog box.

## INTERRUPT - Solver Interrupt

If the *Hold / Interrupt* button is pressed before completion of the solution process, the user can hold the process and continue it some point later, or stop the process via the following dialog box:

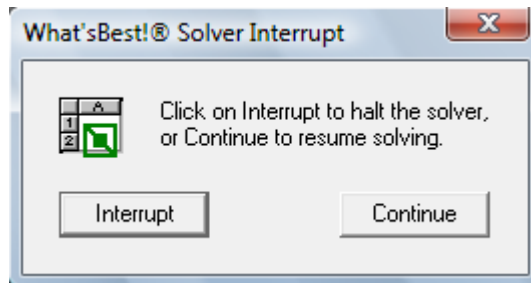

By clicking *OK*, the following warning message is displayed on the *WB! Status* tab in the returned workbook.

### Warning Message:

```
*****
*           INTERRUPTED           *
*****
***WARNING***
```

*Solver Interrupt (Help Reference: INTERRUPT).  
The solver was interrupted before finding the final solution. Check the solution carefully; it may be sub-optimal or infeasible*

**Suggestions:**

When a model is interrupted, there are certain instances when *What'sBest!* will be able to return the best solution found so far. The best way to determine if an incumbent solution exists is by checking the *Best Obj* field in the *What'sBest! Solver Status* window. If this field contains a numeric value, then there is an incumbent solution that can be returned.

If this field does not contain a numeric value, then a valid solution does not exist. In which case, the values returned by the solver will not be valid. Keep in mind that, at best, the returned solution is most likely sub-optimal. Furthermore, whenever you interrupt the solver you should check the final infeasibility value on the *WB! Status* tab of the returned workbook. An infeasibility value significantly different from zero means that some constraints are violated in the returned answer and the solution is not valid.

---

**Note:** If a feasible integer solution is found for an integer optimization model, restoring the best integer solution may take some time after the initial interrupt. So, don't be concerned if the solver doesn't interrupt immediately when the model contains integer adjustable cells. The solver is just busy returning to the incumbent solution.

---

---

## ***INVMOD - Invalid Model***

If you attempt to solve a model that is clearly not formatted for What'sBest!, the following error message will be displayed on the *WB! Status* tab.

### **Error Message:**

\*\*\*ERROR\*\*\*

*Invalid Model (Help Reference: INVMOD):*

*Your model must have at least one adjustable cell and one formula that is dependent upon an adjustable cell. Refer to the "Getting Started" section of the online help to learn how to format a model for What'sBest.*

### **Suggestions:**

The model you are attempting to solve does not have the appropriate formatting for What'sBest! You will need to identify the adjustable cells, identify the best cell and input your constraint cells. Refer to section *ABC's: Basic Functions* for details on how to format a model.

---

## ***IRRECONST - Irreconcilable Constraints***

If a constraint is violated and it does not depend upon any adjustable cells, What'sBest! will not be able to satisfy the constraint and it is considered *irreconcilable*. In which case, the following error message will be displayed on the *WB! Status* tab.

### **Error Message:**

\*\*\*ERROR\*\*\*

*Irreconcilable Constraints (Help Reference: IRRECONST)*

*The cells listed below contain violated constraints that do not depend upon adjustable cells, and, therefore, cannot be reconciled. These constraints were ignored during the solution process. An example of an irreconcilable constraint would be WB( 1, "<=", 0). Please check to see that these constraints have been entered correctly and that all adjustable cells have been specified. (cell addresses listed at bottom of tab)*

### **Suggestions:**

A simple example of an irreconcilable constraint would be: *@WB( 0, ">=", 1)*. Clearly, no matter what values are chosen for the adjustable cells, 0 will never be greater than 1. What'sBest! will provide you with a list of the irreconcilable cell formulas. You will need to either delete them or correct them so that they are functions of the adjustable cells. To correct them, check the cell formulas for errors and be sure that all the adjustable cells have been specified.

---

## ***ITRLIM - Iteration Limit Reached***

By default, *What'sBest!* does not put a limit on the number of solver iterations. However, by using the *Iteration Limit* option on the *General Options* dialog box posted by the *Options...|General* command, the user may limit the number of iterations. When the program has executed the number of iterations you specified without finding a solution, the following warning message will be displayed on the *WB! Status* tab.

### **Warning Message:**

```
*****
*           INTERRUPTED           *
*****
***WARNING***
```

*Iteration Limit Reached (Help Reference: ITRLIM).*  
*The limit for the maximum number of iterations was reached before the final solution could be found. Check the solution carefully; it may be sub-optimal or infeasible. The iteration limit is set via the WB|Options|General menu.*

### **Suggestions:**

The iteration limit is set through the *WB|Options!General* menu. In some cases, the solver may be able to return the best solution found so far after hitting an iteration limit. However, the same precautions regarding the returned solution apply as when interactively interrupting the solver. For more details, refer to section *Solver Interrupt* above.

---

## ***LICCAPP1 - Constraint Limit***

If your model has more constraints than is allowed for your installation, the following error message will be displayed on the *WB! Status* tab.

### **Error Message:**

```
***ERROR***
Constraint Limit (Help Reference: LICCAP1):
The number of constraints in this model:  -number of constraints-
exceeds the limit of:  -constraint limit-
The model has more constraints than is allowed by your installation. You will need
to either reduce the size of your model or upgrade to a larger version.
```

### **Suggestions:**

The model exceeds the constraint limit for your installation. The capacity limits of your version may be found by running the *WB!About What'sBest!* command.

One option is to remove constraint cells from the model until it satisfies the constraint limit. Keep in mind that *What'sBest!* defaults to forcing adjustable cells to be non-negative. So, any constraints that put a lower bound of zero on the adjustable cells are not required and may be removed. Also, if the workbook contains multiple independent models, you can separate them into different workbooks in order to meet the limit.

---



---

If eliminating constraints is not an alternative, then you may wish to contact LINDO Systems regarding a license upgrade to handle the additional constraints

---

## **LICCAP2 - Adjustable Cell Limit**

If your model has more adjustable cells than is allowed for your installation, the following error message will be displayed on the *WB! Status* tab.

### **Error Message:**

\*\*\*ERROR\*\*\*

*Adjustable Cell Limit (Help Reference: LICCAP2):*

*The number of adjustable cells in this model: -number of adjustables-  
exceeds the limit of: -adjustable limit-*

*The model has more adjustable cells than is allowed by your installation.*

*You will need to either reduce the size of your model or upgrade to a  
larger version.*

### **Suggestions:**

The model exceeds the adjustable cell limit for your installation. The capacity limits of your version may be found by running the *WB!About What'sBest!* command.

One option is to remove adjustable cells from the model until it satisfies the limit. Also, if the workbook contains multiple independent models, you can separate them into different workbooks in order to meet the limit.

If eliminating adjustables is not an alternative, then you may wish to contact LINDO Systems regarding a license upgrade to handle the additional constraints.

---

## LICCAP3 - Integer Cell Limit

If your model has more integer cells than is allowed for your installation, the following error message will be displayed on the *WB! Status* tab.

**Error Message:**

\*\*\*ERROR\*\*\*

*Integer Cell Limit (Help Reference: LICCAP3):*

*The number of integer cells in this model: -number of integers-  
exceeds the limit of: -integer limit-*

*The model has more integer cells than is allowed by your installation.*

*You will need to either reduce the size of your model or upgrade to a larger version.*

**Suggestions:**

The model exceeds the integer cell limit for your installation. The capacity limits of your version may be found by running the *WB!About What'sBest!* command.

One option is to remove integer cells from the model until it satisfies the limit.

You should also check that there aren't any unintended ranges of integer cells in the model. Integer cells are flagged by *What'sBest!* using range names that begin with "WBINT" and "WBGIN". Review all such range names to be sure that there are no unintended integer cell ranges.

Some classes of models will return naturally integer values. If your model falls in this category, you can remove the integer formatting and let *What'sBest!* solve the model as a continuous problem.

You may also want to review your demands for an integer solution. For instance, in some models you can simply round the solution to the continuous model with little or no ill effects. For instance, if a model calls for producing 1,247,288.33 pencils, you could safely round the number up or down without significant impact. On the other hand, if the model calls for building .6 space stations, rounding up or down will have a huge impact on the objective and feasibility of the constraints. In which case, rounding is not an option.

Check to be sure that all adjustable cells in the model are still required. Also, if the workbook contains multiple independent models, you can separate them into different workbooks in order to meet the limit.

If eliminating integer cells is not an alternative, then you may wish to contact LINDO Systems regarding a license upgrade to handle the additional constraints.

---

## LICCAP4 - Nonlinear Adjustable Cell Limit

If your model has more nonlinear cells than is allowed for your installation, the following error message will be displayed on the *WB! Status* tab.

**Error Message:**

\*\*\*ERROR\*\*\*

*Nonlinear Adjustable Cell Limit (Help Reference: LICCAP4):*

---

*The number of nonlinear adjustable cells in this model: -number of nonlinears- exceeds the limit of: -nonlinear adjustable cell limit-  
The model has more nonlinear adjustable cells than is allowed by your installation.  
You will need to either reduce the size of your model or upgrade to a larger version*

**Suggestions:**

The model exceeds the nonlinear adjustable cell limit for your installation. The capacity limits of your version may be found by running the *WB!About What'sBest!* command.

An adjustable cell is considered nonlinear if it appears in a nonlinear manner in one or more cell formulas in your workbook. As an example, suppose that cells *A1* and *B1* are both adjustable cells. Furthermore, suppose that we have the following formula somewhere in the workbook:  $SIN(A1) + 3*B1$ . The  $SIN()$  function is a nonlinear function, so this formula causes *A1* to be considered a nonlinear adjustable cell. On the other hand, multiplying an adjustable cell by a constant is a linear operation, so this formula alone would not make *B1* a nonlinear adjustable cell. For more information on identifying and solving linear and nonlinear expressions, see *Overview of Mathematical Modeling*.

Evaluate the formulas in which the nonlinear adjustable cells appear to determine if these formulas can be rewritten as linear expressions. If this is not possible, you will need to either reduce the size of your model or upgrade to a larger version of *What'sBest!*.

When possible, formulate your problem using linear expressions. Problems composed entirely of linear relationships solve faster and more reliably. However, in many cases, linear reformulation may not be possible. If your model contains inherently nonlinear expressions, you may choose to turn off this nonlinear warning with the *Nonlinearity present* checkbox in the *General Options* dialog box.

All versions of *What'sBest!* are supplied with a linear solver. The downloadable and Solver Suite versions of *What'sBest!* provide a nonlinear solver with capacity for a few nonlinear adjustable cells. For the Commercial and more powerful versions of *What'sBest!*, the nonlinear option may be purchased from LINDO Systems.

---

## **LICCAPP5 - Global Adjustable Cell Limit**

If your model has more nonlinear cells than is allowed for your license when you are running the global solver, the following error message will be displayed on the *WB! Status* tab.

**Error Message:**

\*\*\*ERROR\*\*\*

*Global Adjustable Cell Limit (Help Reference: LICCAP5):  
The number of global adjustable cells in this model: -number of globals-- exceeds the limit of: -global adjustable cell limit-  
The model has more nonlinear adjustable cells than is allowed by your installation of the global solver. You will need to either reduce the size of your model or upgrade to a larger version.*

---

**Suggestions:**

The model exceeds the nonlinear adjustable cell limit for your installation of the global solver. This limit is easy to hit on some of the smaller capacity versions of *What'sBest!*, given that they allow only a handful of nonlinear adjustable cells when running the global solver. The capacity limits of your version may be found by running the *WB!About What'sBest!* command. Refer to the previous error message (LICCAP4) for information on the definition of a nonlinear adjustable cell.

You will need to reduce the number of nonlinear adjustable cells in the model or turn off the global solver and use the standard nonlinear solver. If this is not possible, you will need to contact LINDO Systems regarding a license upgrade.

---

## ***LICKEY1 - Failed to Process License Key***

When your *What'sBest!* license key can't be found, read or processed, the following error message will be displayed on the *WB! Status* tab.

**Error Message:**

\*\*\*ERROR\*\*\*

*Failed to Process License Key (Help Reference: LICKEY1):  
Unable to find or read a valid license key. Run the WB!Upgrade command to install  
a valid license key*

**Suggestions:**

You may need to reinstall your license key with the *WB!License* command. Also, make sure the license file, *LNDWB80.LIC*, is installed in the directory along with the *What'sBest!* add-in files (typically *\Program Files\Microsoft Office\Office10\Library*). You may need to contact LINDO Systems to obtain a valid license key

---

## ***LICKEY2 - Pending License Expiration***

If your license key will expire in the next day, the following warning message will be displayed on the *WB! Status* tab.

**Warning Message:**

\*\*\*WARNING\*\*\*

*Pending License Expiration (Help Reference: LICKEY2):  
Your What'sBest! license key will expire at the end of the day.*

**Suggestions:**

You have a temporary license key that will expire at the end of the day. Note that you will still be able to use *What'sBest!* after the license expires, but it will revert to a demonstration version with limited capacity. You may want to contact LINDO Systems to obtain a new license key.

---

---

## LICKEY3 - Expired License Key

When your What'sBest! license key has expired, the following warning message will be displayed on the *WB! Status* tab.

### Warning Message:

\*\*\*WARNING\*\*\*

*Expired License Key (Help Reference: LICKEY3):  
Your license key has expired. You may wish to contact LINDO Systems  
to obtain a new license key..*

### Suggestions:

Your license key has expired. You may continue on running a trial version with limited capacity, or you can contact LINDO Systems to obtain a new license.

---

## LICKEY4 - Pending Expiration of Option Trial

Some versions of What'sBest! include trial licenses for some of the optional capabilities (e.g., the global solver). If the trial license for the options is about to expire, the following warning message will be displayed on the *WB! Status* tab.

### Warning Message:

\*\*\*WARNING\*\*\*

*Pending Expiration of Option Trial (Help Reference: LICKEY4):  
Your trial period for the optional features will expire at the end of the day.  
You can continue to use What'sBest!, but some of the optional features  
may no longer be available.*

### Suggestions:

Some installations come with a free trial period for the optional solvers (Nonlinear, Global and Barrier). In this case, the trial period is about to expire. What'sBest! will continue to operate, but you will no longer have access to all the optional solver engines. You may want to contact LINDO Systems to order a license upgrade that includes permanent access to one or more of the optional solvers

---

## LICKEY5 - License Key Dongle Required

Some versions of What'sBest! include a dongle key with the license. The dongle key is in the form of a key to insert into a USB port of the computer. If this dongle key is required and missing, the following error message will be displayed on the *WB! Status* tab.

### Warning Message:

\*\*\*ERROR\*\*\*

*License Key Dongle Required (Help Reference: LICKEY5):*

*Unable to find or read a valid license key with dongle. Run the*

*WB|License command to install a valid license key.*

### Suggestions:

Some licenses require a dongle key at the time of order to insert into a USB port of the computer. If the dongle key is missing, corrupted, or does not match the license file, so you will not be able to run What'sBest!. What'sBest! can still continue to operate on a demo license capacity. You may want to contact LINDO Systems to order a license upgrade that includes permanent access to one or more of the optional solvers including a dongle key.

---

## LICOPT1 - Global Solver Not Licensed

If you attempt to use the global solver option without a license, the following error message will be displayed on the *WB! Status* tab.

### Error Message:

\*\*\*ERROR\*\*\*

*Global Solver Not Licensed (Help Reference: LICOPT1).*

*The license for your installation does not allow for use of the global solver option.*

### Suggestions:

The global solver is an optional feature. You've attempted to use the global solver with a copy of What'sBest! that does not have an appropriate license. You will need to either disable the global option (*WB!|Options|Global Solver*), or contact LINDO Systems regarding a license upgrade that includes the global option.

---

**Note:** The global solver needs the nonlinear option and the mixed integer option to operate.

---

---

## LICOPT2 - Nonlinear Solver Not Licensed

If you attempt to use the nonlinear solver option without a license, the following error message will be displayed on the *WB! Status* tab.

**Error Message:**

\*\*\*ERROR\*\*\*

*Nonlinear Solver Not Licensed (Help Reference: LICOPT2).*

*The license for your installation does not allow for the solution of nonlinear models.*

**Suggestions:**

The nonlinear solver capability is an optional feature. You've attempted to solve a nonlinear model with a copy of *What'sBest!* that does not have the option enabled. You need to either reformulate the model to eliminate all nonlinear cells, or contact LINDO Systems regarding a license upgrade that includes the nonlinear solver option. For more information on identifying nonlinear expressions, see *Overview of Mathematical Modeling*.

---

## LICOPT3 - Barrier Solver Not Licensed

If you attempt to use the barrier solver option without a license, the following error message will be displayed on the *WB! Status* tab.

**Error Message:**

\*\*\*ERROR\*\*\*

*Barrier Solver Not Licensed (Help Reference: LICOPT3).*

*The license for your installation does not allow for use of the global solver option.*

**Suggestions:**

The barrier solver is an optional feature. You've attempted to use the barrier solver with a copy of *What'sBest!* that does not have an appropriate license. You will need to either disable the barrier option (*WB!Options|Linear Solver*), or contact LINDO Systems regarding a license upgrade that includes the barrier option.

---

## LICOPT4 - Mixed Integer Solver Not Licensed

If you attempt to use the mixed integer programming solver option without a license, the following error message will be displayed on the *WB! Status* tab.

**Error Message:**

\*\*\*ERROR\*\*\*

*Mixed Integer Solver Not Licensed (Help Reference: LICOPT4)*

*The license for your installation does not allow for use of the mixed integer solver option.*

---

**Suggestions:**

The mixed integer programming solver is an optional feature. You've attempted to use the mixed integer solver with a copy of *What'sBest!* that does not have an appropriate license. You will need to either disable any integer options (*WB!*|*Options*|*Integer Pre-Solver*, *WB!*|*Options*|*Integer Solver*), or contact LINDO Systems regarding a license upgrade that includes the mixed integer option.

---

## ***LICOPT5 - Stochastic Solver Not Licensed***

If you attempt to use the stochastic solver option without a license, the following error message will be displayed on the *WB!* *Status* tab.

**Error Message:**

\*\*\**ERROR*\*\*\*

*Stochastic Solver Not Licensed (Help Reference: LICOPT5):*

*The license for your installation does not allow for use of the stochastic solver option.*

**Suggestions:**

The stochastic programming solver is an optional feature. You have attempted to set up a stochastic model with a copy of *What'sBest!* that does not have an appropriate license. You will need to either disable any stochastic features (*WB!*|*Options*|*Stochastic Solver*, *WB!*|*Advanced*|*Stochastic Support*), or contact LINDO Systems regarding a license upgrade that includes the stochastic option.

---

## ***LICOPT6 - Conic Solver Not Licensed***

If you attempt to use the conic solver option without a license, the following error message will be displayed on the *WB!* *Status* tab.

**Error Message:**

\*\*\**ERROR*\*\*\*

*Conic Solver Not Licensed (Help Reference: LICOPT6):*

*The license for your installation does not allow for use of the conic solver option.*

**Suggestions:**

The Conic Solver, or Second Order Cone Programming (SOCP), is invoked when the model is Convex, with Global option set and checked, the Quadratic Recognition on, and the Conic option set.

The conic programming solver is an optional feature. You have attempted to set up a conic model with a copy of *What'sBest!* that does not have an appropriate license. You will need to contact LINDO Systems regarding a license upgrade that includes the conic option.

---



---

## LOOKUP - Unsupported Lookup Usage

What'sBest! supports the *VLOOKUP()* and *HLOOKUP()* Excel® functions only under certain conditions. If you use an unsupported variant of either of these lookup functions, the following error message will be displayed on the *WB! Status* tab.

### Error Message:

\*\*\*ERROR\*\*\*

*Unsupported Lookup Usage (Help Reference: LOOKUP))*

*The solver has been halted because the following cell contains an equation with an unsupported reference to either VLOOKUP() or HLOOKUP(). All arguments must evaluate to being numeric, the third argument must be a numeric constant, and the fourth argument is an optional TRUE/FALSE value.*

*-cell address-*

### Suggestions:

The *VLOOKUP()* function requires three arguments as follows: *VLOOKUP(lookup\_value, table\_array, col\_index\_num, [range\_lookup])*. What'sBest! places the following restrictions on these arguments:

- ◆ the *col\_index\_num* argument must be a value, not a formula or a cell reference,
- ◆ all arguments must evaluate to being numeric rather than text, and
- ◆ *range\_lookup* is an optional TRUE / FALSE argument.

Refer to the What'sBest! sample file *VLOOKUPWBSOLVER.XLS* for an example of valid *VLOOKUP()* usage.

---

## MEMORY - Insufficient Memory

If there is not enough random access memory on your machine, the following error message will be displayed on the *WB! Status* tab.

### Error Message:

\*\*\*ERROR\*\*\*

*Insufficient Memory (Help Reference: MEMORY).*

*There is not enough random access memory on the machine to solve the mode to completion. Try closing all other applications or adding memory.*

*- additional message -*

### Suggestions:

The solver was not able to allocate sufficient memory. Try shutting down any other applications that are open to free up memory. Memory requirements grow along with your model; so reducing the model's size may help too.

Another option is to try and increase the amount of virtual memory available to your computer. Unfortunately, relying on virtual memory rather than true RAM memory will slow the solver down substantially.

---

If all else fails, you should consider adding more memory to your machine. This assumes that you haven't already added the maximum amount of memory possible to your machine. In the case where you have already maxed out your machine, you will need to reduce the size of the model.

---

## ***MODERR - Parsing Cell Formula***

If What'sBest! can't parse a particular cell formula, the following error message will be displayed on the *WB! Status* tab.

### **Error Message:**

\*\*\*ERROR\*\*\*

*Parsing Cell Formula (Help Reference: MODERR):*

*What'sBest! was not able to parse the formula in the following cell:*

*-cell address-*

*-additional message-*

### **Suggestions:**

If a formula contains an unexpected, inappropriate, or unrecognized operation, where a comma is expected instead of the multiplication operator, What'sBest! may not know how to proceed.

Here is a list of possible causes:

- ◆ The formula contains an unsupported combination of cells and areas (e.g., multiplying a range of cells by a numeric value).
- ◆ The formula may reference a cell in an error state (e.g., #NUM!).
- ◆ The cell's formula may exploit some feature unsupported by What'sBest!.
- ◆ Some Excel® functions need to meet a particular format to be supported by What'sBest!.

If the formula still results in this message and the cell is used only for reporting purposes, you may wish to place it in a WBOMIT range to force What'sBest! to ignore the cell.

---

## ***NAME - Unsupported Name***

If What'sBest! can't parse a particular name, the following warning message will be displayed on the *WB! Status tab*.

### **Warning Message:**

\*\*\*WARNING\*\*\*

*Unsupported external value or range in the Name list (Help Reference: NAME):  
Check name, value, or the validity of the link.  
Name will be taken as a 0 number  
Name: -name-*

### **Suggestions:**

What'sBest! does not support names containing any of the following; links to external workbooks, formulas, and symbols. Verify all names using "Insert|Name|Define...", remove any unused names, or copy the external data directly into the current workbook.

You may need to call LINDO Systems for assistance.

---

## ***NLINCELL - Nonlinearities Present***

Assuming the *Nonlinearity Present* checkbox is checked, a model containing nonlinear expressions will produce the following warning message on the *WB! Status tab*. Below the message, What'sBest! provides the names of the cells containing nonlinear relationships.

### **Warning Message:**

\*\*\*WARNING\*\*\*

*Nonlinearities Present (Help Reference: NLINCELL):  
The cells below contain nonlinear expressions. If these cells are used only for reporting, then, for efficiency, they should be included in a WBOMIT range (refer to documentation). In some cases, nonlinear cells may be linearized automatically by the Linearization option that is set in the General Options dialog box. This warning can be turned off with the Nonlinearity Present checkbox in the General Options dialog box  
(cell addresses listed at bottom of tab).*

### **Suggestions:**

A cell is considered nonlinear if it applies nonlinear mathematical operations to quantities that depend on the adjustable cells. As an example, suppose that cells A1 and B1 are both adjustable cells. Furthermore, suppose that we have the following formula somewhere in the workbook: A1/B1. Dividing by an adjustable cell is a nonlinear operation, so this term causes the formula containing it to be considered nonlinear. For more information on identifying and solving linear and nonlinear expressions, see *Overview of Mathematical Modeling*.

When possible, formulate your models using linear expressions. Problems composed entirely of linear relationships solve faster and with a higher degree of confidence. Evaluate the formulas in the nonlinear cells to determine if these formulas can be rewritten as linear expressions. In many cases, a nonlinear expression can be rewritten in an equivalent, but linear, manner. Unfortunately, the

---

techniques for doing this are not particularly intuitive. Referring to a good text on mathematical programming may be of help.

In some cases, the Linearization capability in *What'sBest!* can automatically reformulate your model "under the hood" to make it entirely linear. However, linearizing a model by hand is always more efficient. Plus, if the Linearization feature does not linearize the model completely, you may end up with a more difficult model to solve.

In many cases, linear reformulation may not be possible. If your model contains inherently nonlinear expressions, you may choose to turn off this nonlinearity warning by clearing the Nonlinearity Present checkbox on the *General Options* dialog box.

---

## ***NOADJ - No Adjustable Cells***

Adjustable cells represent activities that are under the solver's direct control. In other words, these cells have been identified as ones that are allowed to be changed by the solver during the optimization process. If there are no adjustable cells in the model, the following error message is displayed on the *WB! Status* tab.

### **Error Message:**

\*\*\*ERROR\*\*\*

*No Adjustable Cells (Help Reference: NOADJ):  
No cells have been specified as adjustable. You must use  
the Adjustable command to specify the cells you want  
What'sBest! to adjust to find the solution. Adjustable  
cells must contain numbers. Adjustable cells that are blank  
or contain formulas or text will be ignored by the solver)*

### **Suggestions:**

You will need to add at least one adjustable cell to the model. See section *The ABC's: Three Steps to What'sBest!* for information on how to mark cells as being adjustable. Adjustable cells are easy to find in that they are displayed in a blue font and have the Adjustable style applied to them. When identifying your adjustable cells, be sure to place a numeric value (any will do) in each adjustable cell. If an adjustable cell does not contain a numeric value, *What'sBest!* will not attempt to change its value.

---

---

## NOBEST - No Best Cell

Most What'sBest! models will have an optimization objective, i.e., a best cell. It could be profit maximization, cost minimization, or some other criterion that is a function of the adjustable cells. So, when a model does not contain a best cell, the following warning will be displayed on the *WB! Status* tab.

### Warning Message:

\*\*\*WARNING\*\*\*

*No Best Cell (Help Reference: NOBEST).*

*Either no cell has been specified to be maximized or minimized, or the cell that is marked is not a function of any adjustable cells. If this is an optimization model, use the Best command or the Minimize or Maximize toolbar button to specify a best cell as the objective of the optimization.*

*This warning can be turned off via the WB\Options\General menu.*

### Suggestions:

If you failed to indicate a best cell before solving, specify a cell to be maximized or minimized and re-solve. Refer to section *The ABC's: Three Steps to What'sBest!* for information on how to identify a best cell. Occasionally, you may have models that don't require a best cell, where all you want to do is find a set of values for the adjustable cells that satisfy all the constraints. In this case, you should disable this warning by clearing the *No Best Cell* checkbox on the *General Options* dialog box.

---

## NOCONST - No Constraint Cells

Most What'sBest! models will have at least one, and most likely many, constraints on the adjustable cells. Constraints place limitations on the adjustable cells and/or functions of the adjustable cells. For instance, resources will never be unlimited. At some usage level resources will be exhausted. Another example would be that orders must be filled. A cost minimization model with no constraints to fill orders would minimize cost by producing nothing, which clearly is not an optimal answer to the real world problem. Constraints are used to indicate these types of limitations. It would be unusual for a model to have no constraints. So, when What'sBest! encounters such a situation, it displays the following warning on the *WB! Status* tab.

### Warning Message:

\*\*\*WARNING\*\*\*

*No Constraint Cells (Help Reference: NOCONST)*

*The solver recognized no valid constraints. The model either contained no constraint functions or only constraint functions that did not depend on any adjustable cells. If the model was developed for an earlier version of What'sBest, the constraints may need to be converted to the current format for constraint functions.*

---

**Suggestions:**

You will need to add at least one constraint cell to the model. Constraints can be created with the *WB!Constraints* command. You may also want to refer to section *The ABC's: Three Steps to What'sBest!* for detailed information on how to create a constraint cell.

On rare occasions it may actually make sense to have an unconstrained model. This would be a model where you need to find the extreme point of an objective function dependent upon unconstrained adjustable cells. In this case, you may want to create a single, vacuous constraint cell in order to avoid this error message (e.g.,  $X \geq -1.e20$ ).

---

## **NUMERICAL - Numerical Error**

In some cases, models will not be numerically stable. In such a case, the solver will not be able to continue when numeric values become too large and the following error message will be displayed on the *WB! Status* tab.

**Error Message:**

\*\*\*ERROR\*\*\*

*Numerical Error (Help Reference: NUMERICAL):*

*The optimizer encountered numerical errors while solving and was unable to continue the optimization. Scaling the model's coefficients so that they don't cover as large a range may be helpful in eliminating this error.*

**Suggestions:**

Typically, this error message occurs when a model is poorly scaled. A model is poorly scaled when the ratio of the largest coefficient to the smallest coefficient in the model's formulas is too high. If this error occurs on a nonlinear model, then you can try a different starting value. If this doesn't seem to help, then you should try rescaling your model. *What'sBest!* displays information on the *WB! Status* tab regarding the values for the largest and smallest coefficients and where they are located in the workbook. This information can be useful in tracking down the poorly scaled parts of the model. Changing the units of measure in your model may help to improve scaling. For example, if your model contains dollar amounts, you may want to try switching to units of thousands of dollars.

---

## **OMITTED - Omitted Cell Reference**

Cells within *WBOMIT* ranges (i.e., cells that have been omitted from the optimization via the *WB!Advanced|Omit* command) cannot be referenced in cell formulas that lie outside *WBOMIT* ranges. When this situation is encountered, *What'sBest!* will display the following error message on the *WB! Status* tab.

**Error Message:**

\*\*\*ERROR\*\*\*

*Omitted Cell Reference (Help Reference: OMITTED).*

*The solver has been halted because the following cells are contained in WBOMIT ranges and have been referenced by formulas that are not contained in any WBOMIT range.*

*-cell addresses-*

---

**Suggestions:**

There are several options here:

- ◆ Remove the omitted cells that are being referenced (i.e., the cells listed in the error message) from all *WBOMIT* ranges.
- ◆ Place the cells referencing the omitted cells in *WBOMIT* ranges too.
- ◆ Eliminate the references to the omitted cells from the un-omitted cell formulas.

---

## QUAPREC - Quadratic Recognition

A *quadratic program* (QP) is any model that is linear with the exception of product terms involving two variables (e.g.,  $3*X*Y$ ). If you have enabled the *Quadratic Recognition* option and you try and solve a quadratic programming model that is non-convex, the following error message will be displayed on the *WB! Status* tab.

**Error Message:**

\*\*\*ERROR\*\*\*

*Quadratic Recognition (Help Reference: QUAPREC)*

*The quadratic solver requires that the model be convex. The model does not satisfy this condition. You must disable the quadratic solver by turning off quadratic recognition and then re-solve. This will cause the general purpose, nonlinear solver to be invoked.*

**Suggestions:**

The *Quadratic Recognition* option is controlled with the *WB|Options|Nonlinear Solver* command. When this option is enabled, the nonlinear solver uses algebraic preprocessing to determine if an arbitrary nonlinear model is actually a quadratic program, in which case, it can be passed to the faster quadratic solver. The quadratic solver assesses the model to determine if it is convex. If the model is found to be non-convex, you will receive this error message. At which point, you must either reformulate the model so that it becomes convex, or turn off quadratic recognition and use the general-purpose, nonlinear solver. Refer to *Overview of Mathematical Modeling* for a discussion of the concept of convexity in math programs.

---

---

## ***RUNTIME - Runtime Limit Reached***

By default, What'sBest! does not put a limit on the total time that the solver will run. However, by using the *Runtime Limit* option on the *General Options* dialog box posted by the *Options...|General* command, the user may limit the number of iterations. When the program exceeds the specified runtime limit, the following warning message will be displayed on the *WB! Status* tab.

### **Warning Message:**

```
*****
*           INTERRUPTED           *
*****
***WARNING***
```

*Runtime Limit Reached (Help Reference: RUNTIME)*  
*The limit for the maximum runtime was reached before the final solution could be found. Check the solution carefully; it may be sub-optimal or infeasible. The runtime limit is set via the WB|Options|General menu.*

### **Suggestions:**

The runtime limit is set through the *WB|Options|General* menu. In some cases, the solver may be able to return the best solution found so far after hitting a runtime limit. However, the same precautions regarding the returned solution apply as when interactively interrupting the solver. For more details, refer to section *Solver Interrupt* above.

The Global Solver for nonlinear model may have limitations when combined with other features, such as the Function Support for Excel® or User's Defined Functions. In such a situation, What'sBest! will display the following warning message, and eventually an additional error message, on the *WB! Status* tab.

---

## ***SOLVERGOP - Global Solver Use***

### **Error Message:**

```
***WARNING***
```

*Global Solver Use (Help Reference: SOLVERGOP):*  
*The Global Solver does not proceed when a User Defined Function or an Unsupported built-in function is found in the instruction list. You may turn off the Function Support via the Advanced menu.*  
*-cell address-*

---



**Suggestions:**

The Global Solver needs a complete understanding of the function in the search of a global optima. Functions that are not supported by default cannot provide any valuable details. The user may choose alternate features:

- ◆ Uncheck the Global Solver to run the Nonlinear solver. Instead of a global solution, the solver may find a local optima.
- ◆ Uncheck the Function Support. Unsupported functions will be read as a constant numeric cell, without any further processing.
- ◆ Define a WBCALCxxx or WBOMITxxx range, depending if the value of the cell should be part of the model to solve.

---

## ***SOLVERR - Solver Error***

Mathematical programming problems are inherently difficult to solve, and, as a result, the *What'sBest!* solver may encounter an error from which it is unable to recover. This should not be a common occurrence, but should the solver encounter such an error, *What'sBest!* will display the following error message on the *WB! Status* tab.

**Error Message:**

\*\*\*ERROR\*\*\*

*Solver Error (Help Reference: SOLVERR).*

*The solver encountered an error from which it was unable to recover. A brief description of the error follows:*

*-error description-*

**Suggestions:**

Solver errors should be an uncommon occurrence, and you may need to contact LINDO Systems to resolve the error. Short of that, here are some suggestions:

- ◆ If the error appears to be numerical in nature and your model is nonlinear, you may want to try restarting from a different point. This will tend to force the solver to take a different path to the solution, and, hopefully, avoid the error condition.
  - ◆ Rescale the model so that the ratio of largest to smallest coefficients is reduced to improve numerical stability. The *What'sBest!* status tab displays the value of these coefficients and the cells in which they appear. Often, simply changing units of measure (e.g., dollars to thousands of dollars) will be enough to bring this ratio into line.
  - ◆ Experimenting with some of the solver parameters via the *WB|Options* command may help solve the problem. However, should this not solve the problem, be sure to restore all options back to their default settings.
  - ◆ You may be able to choose an alternate solver. For example, with linear models you can choose the primal, dual, or barrier solver. For nonlinear models there are two versions of the standard nonlinear solver, a quadratic solver, and a global solver to choose from.
-

---

## ***SPCONFLICT - Stochastic Conflicting Declarations***

Using the stochastic feature, the user has to associate a stage information to a variable cell. The `=WBSP_RAND()` and `WBSP_VAR()` functions are used to specify the timing information. If the arguments to these functions are duplicated, or found to have cross references, the following error message will be displayed on the *WB! Status* tab.

### **Error Message:**

**\*\*\*ERROR\*\*\***

*Stochastic Conflicting Declarations (Help Reference: SPCONFLICT):*

*A Stochastic function cell is incorrectly formatted. It appears the argument cell below refers to a cell being specified by other Stochastic functions, leading to contradictory declarations. Correct the formula and the validity of the arguments by tracking its dependencies or references. The argument cell should be declared only once.  
-cell address-*

### **Suggestions:**

There is a conflicting declaration of the argument cell in the Stochastic timing functions. The timing functions must use the format: `=WBSP_RAND(arg1, cells)` for randoms, or `=WBSP_VAR(arg1, cells)` for variables, where *arg1* is a numeric value or a cell reference to a numeric value, and *cells* is a reference to the cells you want to apply this timing information. The cell reference should be declared once, without cross or duplicated references. For more information on using the stochastic feature refer to section *Options...|Stochastic Solver*.

---

---

## SPCORR - Stochastic WBSP\_CORR Format

Using the stochastic feature, the user has to associate a distribution to a random cell, either discrete or continuous. The `=WBSP_CORR...()` function is used to request a one-argument correlation. If the arguments to this function are not correctly specified, the following error message will be displayed on the *WB! Status* tab.

### Error Message:

\*\*\*ERROR\*\*\*

*Stochastic WBSP\_CORR Format (Help Reference: SPCORR):*

*A WBSP\_CORR... cell with 1 argument is incorrectly formatted. Correct the formula and the validity of the arguments in the cell below. The format should be '=WBSP\_CORR...(arg1, cells)', where 'arg1' is a reference, and 'cells' must refer to random cells.*

*-cell address-*

### Suggestions:

There is an incorrectly formatted distribution function cell in the model. A correlation function cell must use the format: `=WBSP_CORR...(arg1, cells)`, where *arg1* is a cell reference, and *cells* is a reference to the cells you want to apply this correlation type: Kendall, Pearson, or Spearman. The cell reference should be to a random cell. For more information on using the stochastic feature refer to section *Options...|Stochastic Solver*.

---

## SPDIST1 - Stochastic WBSP\_DIST 1 Format

Using the stochastic feature, the user has to associate a distribution to a random cell, either discrete or continuous. The `=WBSP_DIST...()` function is used to request a one-argument distribution. If the arguments to this function are not correctly specified, the following error message will be displayed on the *WB! Status* tab.

### Error Message:

\*\*\*ERROR\*\*\*

*Stochastic WBSP\_DIST 1 Format (Help Reference: SPDIST1):*

*A WBSP\_DIST... cell with 1 argument is incorrectly formatted. Correct the formula and the validity of the arguments in the cell below. The format should be '=WBSP\_DIST...(arg1, cells)', where 'arg1' is a reference, and 'cells' must refer to random cells.*

*-cell address-*

---

**Suggestions:**

There is an incorrectly formatted distribution function cell in the model. A distribution function cell must use the format: `=WBSP_DIST...(arg1, cells)`, where *arg1* is a cell reference, and *cells* is a reference to the cells you want to apply this one-argument distribution. The cell reference should be to a random cell. For more information on using the stochastic feature refer to section *Options...|Stochastic Solver*.

---

## **SPDIST2 - Stochastic WBSP\_DIST 2**

### **Format**

Using the stochastic feature, the user has to associate a distribution to a random cell, either discrete or continuous. The `=WBSP_DIST...()` function is used to request a two-argument distribution. If the arguments to this function are not correctly specified, the following error message will be displayed on the *WB! Status* tab.

**Error Message:**

\*\*\*ERROR\*\*\*

*Stochastic WBSP\_DIST 2 Format (Help Reference: SPDIST2):*

*A WBSP\_DIST... cell with 2 arguments are incorrectly formatted. Correct the formula and the validity*

*of the arguments in the cell below. The format should be '=WBSP\_DIST...(arg1, arg2, cells)', where 'arg1' and 'arg2' are references, and 'cells' must refer to random cells.*

*-cell address-*

**Suggestions:**

There is an incorrectly formatted distribution function cell in the model. A distribution function cell must use the format: `=WBSP_DIST...(arg1, arg2, cells)`, where *arg1* and *arg2* are cell references, and *cells* is a reference to the cells you want to apply this two-argument distribution. The cell reference should be to a random cell. For more information on using the stochastic feature refer to section *Options...|Stochastic Solver*.

---

## **SPDIST3 - Stochastic WBSP\_DIST 3**

### **Format**

Using the stochastic feature, the user has to associate a distribution to a random cell, either discrete or continuous. The `=WBSP_DIST...()` function is used to request a three-argument distribution. If the arguments to this function are not correctly specified, the following error message will be displayed on the *WB! Status* tab.

---

**Error Message:**

\*\*\*ERROR\*\*\*

*Stochastic WBSP\_DIST 3 Format (Help Reference: SPDIST3):*

*A WBSP\_DIST... cell with 3 arguments are incorrectly formatted. Correct the formula and the validity*

*of the arguments in the cell below. The format should be '=WBSP\_DIST...(arg1, arg2, arg3, cells)', where*

*'arg1', 'arg2' and 'arg3' are references, and 'cells' must refer to random cells.*

*-cell address-*

**Suggestions:**

There is an incorrectly formatted distribution function cell in the model. A distribution function cell must use the format: =WBSP\_DIST...(arg1, arg2, arg3, cells), where arg1, arg2 and arg3 are cell references, and cells is a reference to the cells you want to apply this three-argument distribution. The cell reference should be to a random cell. For more information on using the stochastic feature refer to section *Options...|Stochastic Solver*.

## SPERR - Stochastic Error

Using the stochastic feature, the user has to associate the stochastic information to a core model. The set of =WBSP\_...() function is used to set the information. If the arguments of these functions are not correctly specified, or if any piece of information can not be loaded, the following error message will be displayed on the *WB! Status* tab.

**Error Message:**

\*\*\*ERROR\*\*\*

*Stochastic Error (Help Reference: SPERR):*

*Your model must have at least one formula that is dependent upon an adjustable cell,*

*and a random cell. Refer to the 'Getting Started' section of the online help to learn*

*how to format a stochastic model for What'sBest.*

*-cell address-*

*-additional message-*

**Suggestions:**

There is an incorrectly formatted stochastic function cell in the model, or the core model is missing the Adjustable, Best Constraint cells. A stochastic function cell must use the format: =WBSP\_...(cells), where cells is a reference to the cells having the argument value. For more information on using the stochastic feature refer to section *Options...|Stochastic Solver*.

## SPHIST - Stochastic WBSP\_HIST Format

Using the stochastic feature, What'sBest! can return the histogram information on any cells. These values tell you how sensitive the solutions are to various stages of the model. The =WBSP\_HIST() function is used to request histogram values on any cell. If the arguments to this function are not correctly specified, the following error message will be displayed on the *WB! Status* tab.

### Error Message:

\*\*\*ERROR\*\*\*

*Stochastic WBSP\_HIST Format (Help Reference: SPHIST):*

*A WBSP\_HIST cell is incorrectly formatted. Correct the formula and the validity of the arguments in the cell below. The format should be '=WBSP\_HIST(number, cells)', where the 'number' states the number of desired bins, and 'cells' must refer to any cells.*

*-cell address-*

### Suggestions:

There is an incorrectly formatted Stochastic Histogram Report cell in the model. A reporting cell must use the format: =WBSP\_HIST(number, cells), where *number* is a numeric number referring to the number of bins, and *cells* is a reference to the cells you want to report the histogram. The *number* can be left to 0, so the solver will decide the number of bins. The *cells* reference can be any cells. For more information on using the Stochastic Histogram values, refer to section *Options...|Stochastic Solver*.

---

## SPRAND - Stochastic WBSP\_RAND Format

Using the stochastic feature, the user has to associate a stage information to a random cell. The =WBSP\_RAND() function is used to specify the timing information. If the arguments to this function are not correctly specified, the following error message will be displayed on the *WB! Status* tab.

### Error Message:

\*\*\*ERROR\*\*\*

*Stochastic WBSP\_RAND Format (Help Reference: SPRAND):*

*A WBSP\_RAND cell is incorrectly formatted. Correct the formula and the validity of the arguments in the cell below. The format should be '=WBSP\_RAND(stage, cells)', where 'stage' is numeric, and 'cells' must refer to random cells. Also, verify the number of stages in the mode.*

*-cell address-*

*-additional message-*

---

**Suggestions:**

There is an incorrectly formatted random function cell in the model. A random cell must use the format: `=WBSP_RAND(arg1, cells)`, where *arg1* is a numeric value or a cell reference to a numeric value, and *cells* is a reference to the cells you want to apply this timing information. The cell reference should be to a random cell. Also, make sure of the staging consistency in the model. For more information on using the stochastic feature refer to section *Options...|Stochastic Solver*.

---

## ***SPREP - Stochastic WBSP\_REP Format***

Using the stochastic feature, *What'sBest!* can return the solution information on any cells. These values tell you how sensitive the solutions are to various stages of the model. The `=WBSP_REP()` function is used to request solution values on variables, and outcomes on random cells. If the arguments to this function are not correctly specified, the following error message will be displayed on the *WB! Status* tab.

**Error Message:**

\*\*\*ERROR\*\*\*

*Stochastic WBSP\_REP Format (Help Reference: SPREP):*

*A WBSP\_REP cell is incorrectly formatted. Correct the formula and the validity of the arguments in the cell below. The format should be '=WBSP\_REP(cells)', where 'cells' must refer to random or variable cells.*

*-cell address-*

**Suggestions:**

There is an incorrectly formatted Stochastic Report cell in the model. A reporting cell must use the format: `=WBSP_REP(cells)`, where *cells* is a reference to the cells you want to report the solutions. The cell reference should be to a random or a variable cell. For more information on using Stochastic Solution values refer to section: *Options...|Stochastic Solver*.

---

---

## SPSTSC - Stochastic WBSP\_STSC Format

Using the stochastic feature, the user has to specify a table of scenario per stage. The `=WBSP_STSC()` function is used to select this two-column table, where stage is in the first column, and scenario on the second column. If the argument to this function is not correctly specified, the following error message will be displayed on the *WB! Status* tab.

### Error Message:

\*\*\*ERROR\*\*\*

*Stochastic WBSP\_STSC Format (Help Reference: SPSTSC):*

*A WBSP\_STSC cell is incorrectly formatted. Correct the formula and the validity of the arguments in the cell below. The format should be '=WBSP\_STSC(cells)', where 'cells' must refer to a two-column range. Also, review the value of the arguments in the distribution function.*

*-additional message-*

### Suggestions:

There is an incorrectly formatted Stochastic/Scenario cell in the model. Such cell must use the format: `=WBSP_STSC(cells)`, where *cells* is a reference to a two-column range. Also, review the value of the arguments in the distribution function; some of them could be out of range. For more information on using Stochastic Solution values refer to section *Options...|Stochastic Solver*.

---

## SPVAR - Stochastic WBSP\_VAR Format

Using the stochastic feature, the user has to associate a stage information to a variable cell. The `=WBSP_VAR()` function is used to specify the timing information. If the arguments to this function are not correctly specified, the following error message will be displayed on the *WB! Status* tab.

### Error Message:

\*\*\*ERROR\*\*\*

*Stochastic WBSP\_VAR Format (Help Reference: SPVAR):*

*A WBSP\_VAR cell is incorrectly formatted. Correct the formula and the validity of the arguments in the cell below. The format should be '=WBSP\_VAR(stage, cells)', where 'stage' is numeric, and 'cells' must refer to variable cells.*

*-cell address-*

*-additional message-*

### Suggestions:

There is an incorrectly formatted variable function cell in the model. A variable cell must use the format: `=WBSP_VAR(arg1, cells)`, where *arg1* is a numeric value or a cell reference to a numeric value, and *cells* is a reference to the cells you want to apply this timing information. The cell reference

---



---

should be to a variable cell. For more information on using the stochastic feature refer to section *Options...|Stochastic Solver*.

---

## **STRARG - String Arguments Found**

In general, What'sBest! expects all function arguments to be numeric. If any unexpected string arguments were found while parsing the workbook, What'sBest! will display the following warning message on the *WB! Status* tab.

### **Warning Message:**

\*\*\*WARNING\*\*\*

*String Arguments Found (Help Reference: STRARG):*

*Text arguments have been found in formulas. Their values have been taken to be zero. This can lead to infeasible or sub-optimal solutions. Please check the returned solution carefully. If you wish the string arguments to be used, click on the menu Advanced -> String Support -> On -> OK.*

*On the other hand if you want string arguments to be disregarded, this warning can be turned off via the menu Options -> General. (cell addresses listed at bottom of tab).*

### **Suggestions:**

In many instances, text arguments can be replaced by numeric arguments with the same end effect. See if this is possible in the cell formulas listed as part of this error message.

---

## **STRLIST - String List Error**

What'sBest! supports string cells and arguments under certain conditions. If your string listing becomes unsupported, the following error message will be displayed on the *WB! Status* tab.

### **Error Message:**

\*\*\*ERROR\*\*\*

*String List Error (Help Reference: STRLIST):*

*What'sBest encountered an error while loading all the strings. You may need to shorten the string length to save memory, omit cells containing strings, or simplify the format of these strings.*

### **Suggestions:**

What'sBest! may have encountered the following restrictions on the string support

- Too many strings to load to the current allowable memory
  - String containing unsupported characters
  - Illegal string operations
  - The maximum length of the string is too large
  - The return value of a formula cell should be numeric rather than text
  - Omit string cells or sheets that are not relevant to the model
-

Refer to the What'sBest! sample file *VehicleRouting.xls* for an example of valid string argument usage.

---

## **STRRES - String Result of Formula**

What'sBest! supports string cells and arguments under certain conditions, but the formula should return a numeric value instead of a string. The following warning message will be displayed on the *WB! Status* tab.

### **Warning Message:**

\*\*\*WARNING\*\*\*

*String Result of Formula (Help Reference: STRRES):  
What'sBest encountered formulas displaying results in a text form. You can use the String Support feature which allows you to use strings as arguments, but the formula should return a numeric value instead of a string, so their results have been taken to be zero. Otherwise, you may want to set omitted areas to discard these cells (cell addresses listed at bottom of tab).*

### **Suggestions:**

What'sBest! may have encountered the following situations on the string support

- The return value of a formula cell should be numeric rather than text
- A numeric result displayed in a text form
- An illegal string operation
- An omitted string cells or sheets that are not relevant to the model

Refer to the What'sBest! sample file *VehicleRouting.xls* for an example of valid string argument usage.

---

## **SUMIF - Unsupported Sumif Usage**

What'sBest! supports the *SUMIF()* Excel® function only under certain conditions. If you use an unsupported variant of *@SUMIF*, the following error message will be displayed on the *WB! Status* tab.

### **Error Message:**

\*\*\*ERROR\*\*\*

*Unsupported Sumif Usage (Help Reference: SUMIF)  
The solver has been halted because the following cell contains an equation with an unsupported reference to SUMIF(). The first and third arguments to a SUMIF() function must be cell ranges, with the same shape and size. Furthermore, all arguments must evaluate to being numeric, not text.  
-cell address-*

---

**Suggestions:**

The *SUMIF()* function requires three arguments as follows: *SUMIF(range, criteria, sum\_range)*. What'sBest! places the following restrictions on these arguments:

- ◆ the *range* and *sum\_range* arguments must be cell ranges, with the same shape and size,
- ◆ all arguments must evaluate to being numeric rather than text.

Refer to the What'sBest! sample file *SUMIFWBSOLVER.XLS* for an example of valid *SUMIF()* usage.

## **TEMPFILE - Error Managing Temp Files**

What'sBest! makes use of a number of temporary files when solving your model. If What'sBest! encounters a problem managing its temporary files, the following error message will be displayed on the *WB! Status* tab.

**Error Message:**

\*\*\*ERROR\*\*\*

*Error Managing Temporary Files (Help Reference: TEMPFILE):  
An error occurred while attempting to access temporary work files.  
Please delete the following files from the folder containing your  
workbook: LINDOWBS.XLS, LINDOWBX.XLS, LINDOWBS.XLSB, LINDOWBX,  
LINDOWBRC.TXT,  
LINDOWBSOLN.TXT, LINDOWBSTATUS.PRN, LINDOWBSOLN.PRN, LINDOWBSTOC.PRN,  
LINDOWBSTOH.PRN. Also, verify the access rights on this folder to create files. The folder path,  
name should be shorter, and may not contain any symbols.*

**Suggestions:**

This error occurs when temporary work files used by What'sBest! could not be accessed. Go to the folder where your model workbook is located and remove the files listed above. You should then be able to solve your model.

## **UNBOUNDED - Unbounded Model**

If, without violating any constraints, the value of the cell to be maximized can be increased to infinity, or the value of the minimized best cell can be decreased to negative infinity, then the problem is said to be unbounded. In this case, the following error message will be displayed on the *WB! Status* tab.

**Error Message:**

\*\*\*ERROR\*\*\*

*Unbounded Model (Help Reference: UNBOUNDED)  
The value of the cell to be maximized/minimized can be increased/decreased  
without limit, and without violating a constraint. The problem may be  
incorrectly formulated. Be sure that the best cell has been correctly  
specified and all equations and constraints have been correctly formulated.  
Refer to Help at 'Solution Status: Unbounded'.*

**Suggestions:**

Check the formulation to ensure that the adjustable cells, the best cell, and the constraint cells have been properly specified and no constraints have been left out. The returned worksheet will display a large positive or negative number in the best cell, and may have large numbers in one or more adjustable cells. This information can give you an indication of where formulation errors lie. An incorrectly specified best cell or constraint (i.e., Maximizing a cell that should be minimized or incorrectly specifying a greater-than-or-equal-to constraint as a less-than-or-equal-to constraint) may be causing the problem.

---

## ***UNDEFREF - Undefined Reference***

If What'sBest! encounters formulas with #REF! type Excel® errors, the following error message will be displayed on the *WB! Status* tab.

### **Error Message:**

\*\*\*ERROR\*\*\*

*Undefined Reference (Help Reference: UNDEFREF)*

*An invalid cell reference or an invalid output value was found in the formula of the cell listed below. You must correct any illegal references to continue. Running the Update Links command from the WB|Options|General menu may correct the error.  
-cell address-*

### **Suggestions:**

This error can occur if a cell referenced by another cell in the worksheet is deleted or replaced by moving another cell over it. This error can also occur when a file is opened that contains functions created on a system in which the What'sBest! program files were in a different location. The latter problem can be corrected using the *Update Links* button on the *General Options* dialog box posted by the *Options...|General* command. If this is not the result of links needing to be updated, the references in the specified cells need to be corrected to eliminate all #REF! errors.

---

---

## WBCARDFORM - Cardinality Cell Format

If requested, What'sBest! can specify Cardinality sets. Range values tell you over what range a particular set is valid. The =WBCARD() function is used to request Cardinality ranges. If the arguments to this function are not correctly specified, the following error message will be displayed on the WB! Status tab.

### Error Message:

\*\*\*ERROR\*\*\*

*Cardinality Cell Format (Help Reference: WBCARDFORM):*

*A Cardinality cell is incorrectly formatted. Correct the formula and the validity of the arguments in the cell below. The format should be '=WBCARD(number, cells)', where 'number' is numeric, and 'cells' must refer to adjustable cells.*

*-cell address-*

### Suggestions:

There is an incorrectly formatted WBCARD function in the model. A WBCARD function cell must use the format: =WBCARD(number, cells), where number is an integer, and cells is a reference to the cells you want the CARD on. The cell reference should be to an adjustable cell. For more information on range values refer to section: *Integer...|Special Ordered Sets*

---

## WBDUFORM - Dual Cell Format

If requested, What'sBest! can return dual solution information. Dual values tell you how sensitive the final solution is to various parts of the model. The @WBDUAL() function is used to request dual values. If the arguments to this function are not correctly specified, the following error message will be displayed on the WB! Status tab.

### Error Message:

\*\*\*ERROR\*\*\*

*Dual Cell Format (Help Reference: WBDUFORM)*

*A dual cell is incorrectly formatted. Correct the formula in the cell below. The format should be '=WBDUAL(cell, value)'.*

*-cell address-*

### Suggestions:

There is an incorrectly formatted dual cell in the model. A dual cell must use the format: =WBDUAL(cell, value), where cell is a reference to the cell you want the dual value on and value is a numeric quantity. The cell reference should be to either a constraint cell or an adjustable cell. You may use any numeric value for value; What'sBest! will replace value with the actual dual value the next time you run the solver. For more information on using dual values refer to section *Advanced|Dual*.

---

## WBLOFORM - Lower Range Cell Format

If requested, What'sBest! can return ranging information. Range values tell you over what range a particular dual value is valid. The @WBLOWER() function is used to request lower ranges. If the arguments to this function are not correctly specified, the following error message will be displayed on the WB! Status tab.

### Error Message:

\*\*\*ERROR\*\*\*

*Lower Range Cell Format (Help Reference: WBLOFORM)*

*A lower range cell is incorrectly formatted. Correct the formula in the cell below. The format should be '=WBLOWER(cell, value)'.*

*-cell address-*

### Suggestions:

There is an incorrectly formatted lower range cell in the model. A lower range cell must use the format: =WBLOWER(*cell*, *value*), where *cell* is a reference to the cell you want the range value on and *value* is a numeric quantity. The cell reference should be to either a constraint cell or an adjustable cell. You may use any numeric value for *value*; What'sBest! will replace *value* with the actual lower range value the next time you run the solver. For more information on using range values refer to section *Advanced|Dual*.

---

---

# WBSEMICFORM - Semi-continuous Cell Format

If requested, What'sBest! can specify Semi-continuous sets. Range values tell you over what range a particular set is valid. The =WBSEMIC() function is used to request Semi-continuous ranges. If the arguments to this function are not correctly specified, the following error message will be displayed on the *WB! Status* tab.

**Error Message:**

\*\*\*ERROR\*\*\*

*Semi-continuous Cell Format (Help Reference: WBSEMICFORM):*

*A Semi-continuous cell is incorrectly formatted. Correct the formula and the validity of the arguments in the cell below. The format should be '=WBSEMIC(lower, upper, cells)', where 'min' and 'max' are constant numbers, and 'cells' must refer to adjustable cells.*

*-cell address-*

**Suggestions:**

There is an incorrectly formatted WBSEMIC function in the model. A WBSEMIC function cell must use the format: =WBSEMIC(lower, upper, cells), where *lower* and *upper* are numbers, and *cells* is a reference to the cells you want the semi-continuous on. The cell reference should be to an adjustable cell. For more information on range values refer to section *Integer...|Semi-continuous*.

---

---

## WBSOSFORM - Special Ordered Sets Cell Format

If requested, What'sBest! can specify Special Ordered Sets. Range values tell you over what range a particular set is valid. The =WBSOS1(), =WBSOS2(), or =WBSOS3() functions are used to request SOS ranges. If the arguments to this function are not correctly specified, the following error message will be displayed on the *WB! Status* tab.

### Error Message:

\*\*\*ERROR\*\*\*

*Special Ordered Sets Cell Format (Help Reference: WBSOSFORM):*

*A SOS cell is incorrectly formatted. Correct the formula and the validity of the arguments in the cell below. The format should be '=WBSOS1(cells)', where 'cells' must refer to adjustable cells.*

*-cell address-*

### Suggestions:

There is an incorrectly formatted WBSOSx function in the model. A WBSOSx function cell must use the format: =WBSOS1(cells), where *cells* is a reference to the cells you want the SOS on. The cell reference should be to an adjustable cell. For more information on range values refer to section *Integer...|Special Ordered*.

---

## WBUPFORM - Upper Range Cell Format

If requested, What'sBest! can return ranging information. Range values tell you over what range a particular dual value is valid. The @WBUPPER() function is used to request upper ranges. If the arguments to this function are not correctly specified, the following error message will be displayed on the *WB! Status* tab.

### Error Message:

\*\*\*ERROR\*\*\*

*Upper Range Cell Format (Help Reference: WBUPFORM)*

*An upper range cell is incorrectly formatted. Correct the formula in the cell below. The format should be '=WBUPPER(cell, value)'.*

*-cell address-*

### Suggestions:

There is an incorrectly formatted upper range cell in the model. An upper range cell must use the format: =WBUPPER(cell, value), where *cell* is a reference to the cell you want the range value on and *value* is a numeric quantity. The cell reference should be to either a constraint cell or an adjustable cell. You may use any numeric value for *value*; What'sBest! will replace *value* with the actual lower range value the next time you run the solver. For more information on range values refer to section *Advanced|Dual*.

---



---

# Appendix A: Installation Details

---

## Installation

To install *What'sBest!*, run the *What'sBest!* setup program and follow the prompts. Following is a description of the screens that will be seen in the setup program. The third screen entitled *Setup Type* will give a choice between a *Default* or *Specified* installation. If for some reason you are prompted with a screen not described here, follow the directions on it as it has the latest information available.

Please close all applications, Excel® included, during the installation.

### *Version 32-bit, 64-bit*

*What'sBest!* 64-bit should be installed with Excel® 64-bit, on a 64-bit operating system. Otherwise, install the 32-bit version of *What'sBest!*.

### *What'sBest! Example Files*

Example files can be installed on a local drive or any drive on the network in which you have write privileges. It is important that *What'sBest!* users avoid sharing a directory for Excel® data files. If *What'sBest!* users share a common data directory over the network, the data files of one user could be inadvertently overwritten by the data files of another user. If this installation is for multiple users, it is recommended that the example files (\*.XLS) be copied to a private data directory for each user.

### *Setup Type*

When prompted for setup type of *Default* or *Specified*, choosing *Specified* installation will ensure that you are prompted to confirm the location of the version of Excel® you are installing with. It also prompts you for the location of the *What'sBest!* program files, which can be on a local drive or any drive on the network in which you have write privileges.

Users who wish to accomplish the following:

- ◆ Installing *What'sBest!* on a network,
- ◆ Installing on systems with multiple versions of Excel®, or
- ◆ Operating a non-English version of Windows®.

will need to select a *Specified* installation.

If Excel® is installed on a network server, the *What'sBest!* add-ins files should be installed and run locally. If you have a network license or site license, then you can follow the instructions in this section to install *What'sBest!* to the server and set up directories for each node. If you have questions regarding installation of *What'sBest!*, the type of license you have, or the number of copies licensed to you, please call LINDO Systems.

It is important that *What'sBest!* users avoid sharing a directory for spreadsheet data files. When solving a model, *What'sBest!* saves a copy of the model and creates a copy of the solved model under the same file names each time. If *What'sBest!* users share a common data directory over the network, the data files of one user could be inadvertently overwritten by the data files of another user.

### *What'sBest! Add-in Files*

The setup program will attempt to locate Excel® and find a *Library* folder in the dialog box, but it is possible it may fail or will find a version of Excel® different from the desired one. Therefore, it is important that you confirm that the supplied path is correct and otherwise correct it.

### *Location of the Add-In Files*

This provides you with the choice of where the add-in files are to be located. The recommended choice of the *Library* subdirectory is already selected. See the section entitled *Location of the Add-in Files and Update Links* for details.

#### Final Instructions

This gives some important instructions to complete the installation of *What'sBest!*. When *What'sBest!* setup is almost complete, click *Finish* and Excel® will open. You may receive a message that *WBINTR.XLS* contains macros. You must then select the *ENABLE MACROS* button in order to finish installation. Also, you can choose to view the *README* file.

Add-ins, library and executable files from LINDO Systems are digitally signed.

### *Installation Related Problems*

Most errors during installation result in clear on-screen messages and instructions for remedying the errors.

If, for instance, you specify installation to a non-existent directory, the setup program asks you if you want to create such a directory now or quit installation. Missing spreadsheet software, found configuration files, and incorrect spreadsheet releases are all handled similarly.

If, after following all on-screen instructions and referring to *Troubleshooting*, you still have trouble installing *What'sBest!*, please call LINDO Systems.

### *Settings for Microsoft® Excel® 2007, 2010, 2013*

Via the Ribbon, select:

File/Office Button

Excel options

---

Popular

- Show Developer tab in the Ribbon

File/Office Button

Excel options

Manage Excel Add-ins Go

- Check \_What'sBest!
- or Browse to WBA.XLAM, usually in "C:\Program Files\Microsoft Office\Office12\Library\LINDOWB"

File/Office Button

Excel options

Trust Center

Trust Center Settings

Macro Settings

- Enable all macros (possibly)
- Trusted Publishers to LINDO Systems Inc

### *Settings for Microsoft® Excel® 1997-2003*

Via the Menubar, select:

Tools

Add-ins

- Check \_What'sBest!
- or Browse to WBA.XLA, usually in "C:\Program Files\Microsoft Office\Office11\Library\LINDOWB"

Tools

Customize

Toolbars

- Check \_What'sBest!

Tools

Options

Security

Macro Security

- Security Level to medium
-

- Trusted Publishers to LINDO Systems Inc

**Note :** A previous add-in link may be remaining under the name "wba" that should be deleted

---

## Add-ins

If you wish to disable (remove) the *What'sBest!* add-in and menu, you may do so by going to the Excel® menu's *Tools|Add-ins* dialog. You can then uncheck the *What'sBest!* add-in from the list, which disables the add-in while you are still in Excel®. When you reopen Excel®, the *WB!* menu item will not be present. The *What'sBest!* add-in and its menu are reenabled by checking the *What'sBest!* add-in from the list posted by the *Tools|Add-Ins* dialog. If *What'sBest!* does not appear in the current list of add-ins, the *browse* button can be used to locate it. The add-in file *WBA.XLA*, or *WBA.XLAM*, can be found in the *Library* subdirectory or the *WB* subdirectory on your C: drive (or elsewhere if you so requested). Details are described in *Location of the Add-in Files and Update Links*. (Please note that it is not possible to disable the *What'sBest!* menu if the add-in is installed to the *XLSTART* subdirectory).

The *What'sBest!* functions are only available when the *What'sBest!* add-in is loaded. If you disable (remove) the *What'sBest!* add-in from Excel®, then you must manually re-enable it the next time you wish to build or solve a model.

---

**Note 1:** Starting with *What'sBest!* release 6.0.1, the add-in name is now *WBA.XLA* (instead of the former *WB.XLA* name). Starting *What'sBest!* release 10.0.0.0, the add-in name can be either *WBA.XLA* for Excel® 2002, or *WBA.XLAM* for Excel® 2007.

---

---

**Note 2:** Add-ins, library and executable files from LINDO Systems are digitally signed.

---

# Location of the Add-In Files and Update Links

If you have already installed *What'sBest!*, then you can check the location of the add-in files (WBA.XLA or WBA.XLAM) at the bottom of the *About What'sBest!* dialog box. The installation program will detect if a previous release of *What'sBest!* has been installed. Thus, it will ask if you wish to remove it first or want to write over it.

## Location of the Add-in Files and Update Links

Your choice of the Default installation option during the setup program will automatically transfer the program files to the Library subdirectory of your main Excel® directory, usually C:\Program Files\Microsoft Office\Office10\Library\LINDOWB for Excel® 2002, or in C:\Program Files\Microsoft Office\Office14\Library\LINDOWB for Excel® 2010. You will find the following files:

- CONOPTx.DLL
- LIBIOMP5MD.DLL
- LINDOx\_0.DLL
- LINDOCU\_xx.DLL
- LINDOPRx.DLL
- LINDOWBEF.DLL
- LINDOWBIL.DLL
- LNDWBxxx.LIC
- MOSEKx\_0.DLL
- MXST32.LIB
- README.WRI
- VCREDIST\_x86.EXE
- WBA.XLA (Excel® 2003) or WBA.XLAM (Excel® 2007 and later)
- WBINTR.XLS
- WBOPT.DLL
- WBOPTLINK.EXE
- WBUNCHADD.EXE

The Help file will be stored in the same directory:

- LINDOWBHELP.CHM

Finally, sample workbooks will be installed in C:\WB.

The 64-bit files are identified with the '64' inside the file name.

The *Specified* installation differs from the *Default* option only with respect to placement of the add-in files. It first check if a *Library* subdirectory already exists, but then the setup program lets you choose the most convenient place for locating the *What'sBest!* add-in files. As a reminder, you might consider the following folders for *What'sBest!* add-in files:

---

---

**LIBRARY** - the *Library* subdirectory of your main Excel® directory, usually a path ending in "Program Files\Microsoft Office\Office14\Library\LINDOWB". This *LINDOWB* subdirectory is the recommended location for installing the *What'sBest!* program files.

**XLSTART** - the *XLSTART* subdirectory of your main Excel® directory. Unlike using other location options, if installed to the *XLSTART* directory, the *What'sBest!* menu cannot be disabled through the dialog box posted by the Excel® menu command *Tools|Add-ins*.

**WB** - the *What'sBest!* directory where the sample files are installed.

---

**Note:** If you are running Excel® from a server, verify if you have write access to Excel®'s *Library* or *XLSTART* subdirectories.

---

In the Windows Registry, *What'sBest!* creates two keys in the following locations:

"HKEY\_CURRENT\_USER-Software-LINDO Systems, Inc." for CheckUpdate, Language, and Registration.

---

**Note:** When you re-enable *What'sBest!*, it appears on the list given by *Tools|Add-ins...* if the add-in is installed to the *Library* directory. If it is not on the list, you may use the *Browse* button on the *Add-ins* dialog box to specify the location of the *WBA.XLA* or *WBA.XLAM* add-in file in the *WB* directory.

---

# Uninstall Files

There are two ways to uninstall *What'sBest!*. First, you can rerun the executable file used for the initial installation. Alternatively, you can open the *Control Panel* of your Windows® operating system, select the *Add/Remove Programs* icon, click on *What'sBest!* in the list of programs, and click the *Add/Remove* button. Both of these ways will redirect you to a common *What'sBest!* maintenance window that resembles the following:

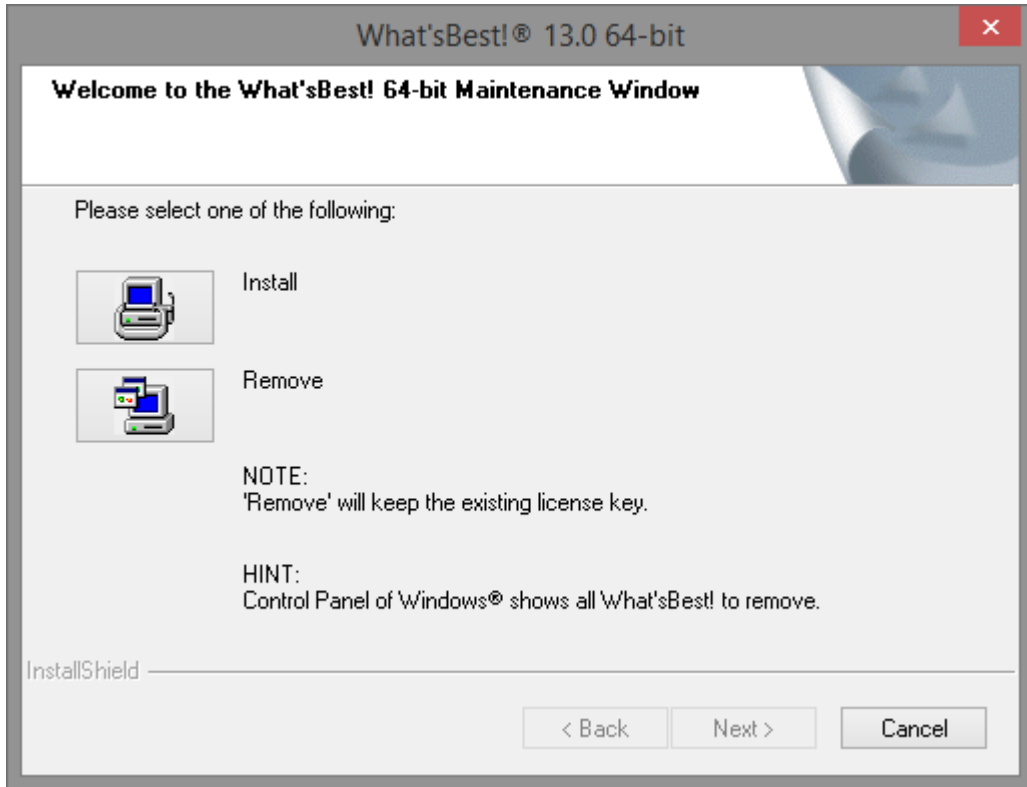

Simply click on the *Remove Only* button. Then, a dialog box will appear to confirm your choice. By clicking *Yes*, your *What'sBest!* add-in files will be completely removed. Selecting *No* and then *Cancel* will close the uninstall program.

After uninstalling the software, you might want to verify that Excel® has cleaned up its own lists (e.g., *Toolbar* and *Add-ins* available). To do this, simply open Excel®, and choose the *Tools|Add-ins...* command or the Office Button, then *Options|Add-ins*. If the *What'sBest!* add-in appears in the list of *Add-Ins available*, click on the check box before it. An error message should appear informing you that the *WBA.XLA* or *WBA.XLAM* file can not be found and prompt you to delete it. Thus, click *Yes* and the entry will be removed from the list.

Similarly, to clean up the Excel® list of toolbars, choose the *View|Toolbars|Customize...* command or right click on the Ribbon bar. If the *What'sBest!* toolbar appears in the list of *Toolbars:*, select the *What'sBest!* toolbar, click the *Delete* button, and click the *OK* button to delete it from the list.



The What's*Best!* add-in can always be reinstalled by launching the installation program again.



---

# Appendix B: Contacting LINDO Systems

---

If you have questions or problems running the software, or you have a suggestion regarding the software or documentation, you can contact LINDO Systems by e-mail, phone, FAX, or mail.

E-mail is often the best means of submitting questions regarding the operation of the software because it allows us to research the questions and provide detailed answers. To resolve a problem running a specific model, we may require that you attach a copy of the model in your email. All models sent to LINDO Systems are treated as strictly confidential.

Sales and Marketing can be reached at:

*e-mail:* [sales@lindo.com](mailto:sales@lindo.com)  
*phone:* (312) 988 7422  
*FAX:* (312) 988 9065  
*Mail / Courier:* LINDO Systems, Inc.  
1415 North Dayton Street  
Chicago, IL 60642  
-USA-

Tech support is available during business hours: 9:00 AM to 5:00 PM Central Time.

*e-mail:* [tech@lindo.com](mailto:tech@lindo.com)  
*Phone:* (312) 988 9421

General information:

*e-mail:* [info@lindo.com](mailto:info@lindo.com)  
*phone:* (800) 441 BEST, (800 441 2378)

**www.lindo.com**

From our website, [www.lindo.com](http://www.lindo.com), you can download trial versions of any of our optimization products. You can also find a database of sample models and past newsletters to assist you in your modeling efforts. Our website also accommodates online ordering and upgrading information.



---

# Index

---

- #
- #REF!, 450
- 0
- 0/1 integer variables, 2, 44
- A
- ABC steps, 9, 12
- About What'sBest!, 133
- ABS, 205
- Absolute, 74
- Absolute value function (ABS), 207
- Absolute Violation, 67, 182
- Absolute Width, 67, 182
- Access, 145, 151
- Acknowledgements, 2
- ACOS, 205
- ACOSH, 205
- Active, 39
- ADDINLINK, 408
- Additional commands, 41
- Adjustable button, 22
- Adjustable cell, 9, 12
- Dual Value for, 114
- Adjustable command, 22
- refers to, 23
- Adjustable dialog box, 22, 24
- Adjustable-Best-Constraints Steps, 9
- Advanced...|Parameters, 126
- Advanced...|Dual, 110
- Advanced...|Dual..., 110
- Advanced...|Function Support, 126
- Advanced...|Omit, 124
- Advanced...|Omit..., 124
- Advanced...|Parameters, 129
- Advanced...|Stochastic Support, 128
- Advanced...|String Support, 127
- Advertising, 324
- Algebraic Reformulation, 67
- Algorithms, 42
- Alpha, 308
- alternate optima, 79
- American option, 390
- AND function, 205, 207
- Arc, 270
- ARITHERR, 409
- ASIN, 205
- ASINH, 205
- Asset, 292, 298
- ASSIGN.XLSX, 353
- ATAN, 205
- ATAN2, 205
- ATANH, 205
- Audience, 324
- AVERAGE, 205
- B
- Backsolving, 221
- Backward analytical, 64
- Barrier, 59, 75
- Base, 304
- Best bound, 78
- Best Button, 25
- Best cell, 9, 13, 25
- none, 26
- Best command, 25
- Best dialog box, 25
- Best Objective Bound, 39
- Beyond VBA, 145
- Binary integer variables, 2, 44
- Blending Models, 258
- BLKCELL, 409
- BLOCK.XLSX, 334
- Bond portfolio optimization, 278
- BONDS.XLSX, 278
- Bounding constraints, 223
- Box Design, 267
- Box Selection, 67
- BOX.XLSX, 267
- Branching Direction, 67, 74
- Budget, 324
- C
- CALL, 408
- Capacity, 320, 344, 369
- Car pricing, 320
- Cardinality constraint, 46
- Cash flow, 278

Cell  
    best command, 26  
    dual value range, 111  
Central Differences, 64  
Chance Constrained Modeling, 244  
CheckUpdate, 139  
Classification Data, 37  
Coefficient Reduction, 72  
Cold Start, 75  
Commercial Version, 134  
concave, 27, 32  
Concavity, 218  
conic programming, 62, 251, 430  
Constraint cells, 9  
    automatic generation of, 15  
    creating, 27  
Constraint Cuts, 71  
Constraint Ranges, 118  
Constraint Related Problems, 31  
Constraints, 134  
    Button, 27  
    command, 27  
    dialog box, 27  
Constraints..., 27  
Contacting Lindo Systems, 465  
Container, 379  
convert model format, 128  
convex, 27, 32  
convex., 217  
Convexity, 217  
Copyright, 2  
COS, 205  
COSH, 205  
Cost, 258, 263, 267, 284, 292, 313, 317, 339, 344,  
    349, 360, 369, 376  
Covariance matrix, 288  
Crop Allocation, 383  
CROPALLOC.XLSX, 383  
CUTSTOCK.XLSX, 339

## D

Default, 4  
Define Best, 16  
Delta, 66  
Demand, 327, 339, 376  
Depth First, 67, 78  
Derivatives, 64  
Design, 267  
Determine Adjustable cells, 9  
Determine Best, 9  
Determine Constraints, 9

Devex, 60  
Direction, 39  
Disaggregation, 72  
Disclaimer, 2  
Disk space, 3  
Distribution, 373  
DNRISK.XLSX, 295  
Downside risk, 298  
Dual, 75  
Dual dialog box, 110  
Dual Pricing, 60  
Dual Value, 111  
    of a Constraint Cell, 112  
    of an Adjustable cell, 114  
    of Zero and Multiple Optima, 117  
Dual values, 112  
    and Multiple Optima, 117  
    in Integer Problems, 117  
    in Nonlinear problems, 117  
    in Nonlinear Problems, 117  
    Valid ranges for, 117

## E

Embedding in a Visual Basic project, 145  
Engineering Models, 267, 270  
Error, 304, 308  
Error Codes, 160  
Error from VBA code, 406  
Error messages  
    Iteration Limit, 422, 438  
    no feasible solution found, 221  
    solution status  
        globally optimal, 220  
        locally optimal, 215  
    Undefined Arithmetic Value, 409  
    Unexpected Operation, 432  
Error messages & Warnings, 406  
    Adjustable Cell Limit, 423  
    Barrier Solver Not Licensed, 429  
    Constraint Limit, 422  
    Dual Cell Format, 451  
    Error Managing Temp Files, 449  
    Excel File Format, 410  
    Expired License Key, 427  
    External Reference, 412  
    Failed to Access the Add-in, 413  
    Failed to Access the Macro, 413  
    Failed to Access the Server, 414  
    Failed to Process License Key, 426  
    Formula Parsing, 411  
    Global Adjustable Cell Limit, 425

- 
- Global Solver Not Licensed, 428
  - Hidden Solvers Names, 415
  - Integer Cell Limit, 424
  - Invalid Model, 421
  - Irreconcilable Constraints, 421
  - Iteration Limit Reached, 422
  - Large Infeasibility, 419
  - Lower Range Cell Format, 452
  - No Adjustable Cells, 416
  - No Best Cell, 435
  - No Constraint Cells, 435
  - No Feasible Solution Found, 418
  - Nonlinear Adjustable Cell Limit, 424
  - Nonlinear Solver Not Licensed, 429
  - Omitted Cell Reference, 436
  - Parsing Cell Formula, 432
  - Pending Expiration of Option Trial, 427
  - Pending License Expiration, 426
  - Quadratic Recognition, 437
  - Runtime Limit Reached, 438
  - Solver Error, 439
  - Solver Interrupt, 419
  - Stochastic Error, 440
  - String Arguments Found, 447
  - String List Error, 447
  - String Result of Formula, 448
  - Unbounded Model, 449
  - Undefined Reference, 450
  - Unsupported Functions, 411
  - Unsupported Lookup Usage, 431
  - Unsupported Name, 433
  - Unsupported Sumif Usage, 448
  - Upper Range Cell Format, 454
  - Error messages & Warnings
    - Multiple Add-in Links, 408
  - Error messages & Warnings
    - Arithmetic Error, 409
  - Error messages & Warnings
    - Blank Cell Warning, 409
  - Error messages & Warnings
    - K-Best WBIKB\_REP Format, 417
  - Error messages & Warnings
    - Indicator Model Cell Reference, 417
  - Error messages & Warnings
    - License key Dongle Required, 428
  - Error messages & Warnings
    - Mixed Integer Solver Not Licensed, 429
  - Error messages & Warnings
    - Stochastic Solver Not Licensed, 430
  - Error messages & Warnings
    - Conic Solver Not Licensed, 430
  - Error messages & Warnings
    - Stochastic WBSP\_CORR Format, 441
  - Error messages & Warnings
    - Stochastic WBSP\_DIST 1 Format, 441
  - Error messages & Warnings
    - Stochastic WBSP\_DIST 2 Format, 442
  - Error messages & Warnings
    - Stochastic WBSP\_DIST 3 Format, 442
  - Error messages & Warnings
    - Stochastic Error, 443
  - Error messages & Warnings
    - Stochastic WBSP\_HIST Format, 444
  - Error messages & Warnings
    - Stochastic WBSP\_RAND Format, 444
  - Error messages & Warnings
    - Stochastic WBSP\_REP Foramt, 445
  - Error messages & Warnings
    - Stochastic WBSP-STSC Format, 446
  - Error messages & Warnings
    - Stochastic WBSP\_VAR Format, 446
  - Error messages & Warnings
    - Cardinality Cell Format, 451
  - Error messages & Warnings
    - Semi-continuous Cell Format, 453
  - Error messages & Warnings
    - Special Ordered Sets Cell Format, 454
  - Estimation Model, 313
  - Excel, 3, 4, 145, 151
  - EXLVER, 410
  - EXP, 205
  - Exponential smoothing, 308
  - Exposure, 324
  - Expressions
    - convex, 217
    - linear, 213
    - nonlinear, 214
    - Nonsmooth, 218
    - Smooth, 218
  - Extended Version, 134
- F
- FALSE, 205
  - feasibility tolerance, 52
  - FIXED1.XLSX, 360
  - FIXED2.XLSX, 360
  - Flow, 270, 376
  - Flow Cover, 72
  - Flow Network Modeling, 270
  - FLOWNET.XLSX, 270
  - Forecasting Models, 304, 308
  - FORMULA1, 411
  - FORMULA2, 411
  - FORMULA3, 412
-

Forward Analytical, 64  
Forward Differences, 64  
Free, 24  
    Deleting designation, 24  
    variables, 24  
FUNCADDIN, 413  
FUNCMACRO, 413  
FUNCSERVER, 414  
Function, 147  
Functions, 205–12  
    convex, 217  
    linear, 213  
    nonlinear, 214

## G

GCD, 72  
General and Operational Problems, 399  
General integer variables, 2, 44  
General Modeling Guidelines, 222  
General Options Dialog Box, 51  
Global, 134  
Global Distance, 67  
Global optima, 220  
Global Solver, 66  
Global Solver Options Dialog Box, 65  
Global Width, 67  
Goal seeking, 221  
Gomory, 72  
GUB, 72

## H

Help, 133  
Heuristics Level, 69  
Hidden cell, 23, 146  
Hide model, 146  
HIDSNAME, 415  
Histogram, 231  
HLOOKUP, 205, 207, 431  
HOGCHANC.XLSX, 263  
HOGFEED.XLS, 258  
Hold / Interrupt, 419  
Hurdle, 77

## I

IF function, 205, 207  
IKBREP, 417  
INDICMOD, 417  
Industrial Version, 134  
Infeasibility, 39

INFEASIBLE, 221, 418  
INFLARG, 419  
Ingredients, 258  
Initial Values, 223  
Installation, 4, 455–63  
INT, 205  
Integer command  
    refers to, 44  
Integer names in workbook, 44  
Integer Pre-Solver Options Dialog Box, 68  
Integer problems, 224  
    binary, 2, 44  
    general, 2, 44  
    Solution method in, 73  
Integer Solver Options Dialog Box, 73  
Integers, 134  
Integers...|Integer Binary, 43  
Integers...|Semi-continuous, 48  
Integers...|Special Ordered Set, 45  
Integrality, 74  
Interactive environment, 7  
INTERRUPT, 419  
Invalid Outside Procedure, 408  
INVENT.XLSX, 327  
Inventory, 308, 327, 330  
Invest, 292, 295  
Investment, 298  
INVMOD, 421  
IRRECONST, 421  
Iteration Limit for Slow Progress, 64  
ITRLIM, 422

## K

K-Best Solutions, 82  
Knapsack, 379  
Knapsack Cover, 72  
Kuhn-Tucker, 220

## L

Language, 141  
Lattice, 72  
Left hand side, 27  
LHS, 27  
LICCAP1, 422  
LICCAP2, 423  
LICCAP3, 424  
LICCAP4, 424  
LICCAP5, 425  
License key, 4  
License Key, 136

---



LICKEY1, 426  
 LICKEY2, 426  
 LICKEY3, 427  
 LICKEY4, 427  
 LICKEY5, 428  
 LICOPT1, 428  
 LICOPT2, 429  
 LICOPT3, 429  
 LICOPT4, 429  
 LICOPT5, 430  
 LICOPT6, 430  
 Lifting, 72  
 Lindo Systems Inc., 465  
 Linear  
   expressions, 213  
   Formulas, 213  
   regression, 313  
 Linear Solver Options Dialog Box, 58  
 Linear vs. Nonlinear Expressions and Linearization,  
 213  
 linearization, 54  
 Linearization, 207, 214, 313  
 LINEARZ.XLSX, 313  
 Linus Schrage, 2  
 LN, 205  
 Load, 379  
 Local Optima, 215  
 Local Width, 67  
 Locally Optimal, 220  
 Locate..., 132  
 Location of the Add-in files and Update files, 460  
 LOCKBOX.XLSX, 284  
 Locked cell, 23, 146  
 LOG, 205  
 Logical operators, 205  
 LOOKUP, 431  
 Looping Macro, 150  
 Lower Range, 110, 117  
 LP Solver, 75

## M

Macros, 147  
 Macros in VBA, 143  
 Make Adjustable, 22  
 Make Adjustable & Free or Remove Free, 23, 24  
 Markowitz Portfolio Model, 288  
 MARKOWITZ.XLSX, 288  
 Mathematical functions, 205  
 MAX function, 205, 207  
 Max Passes, 71  
 Maximize Best, 25

Media Buying, 324  
 MEDIA.XLSX, 324  
 Menu bar, 7  
 Menu commands, 7  
 Microsoft Windows, 3  
 MIN function, 205  
 Minimize Best, 25  
 Minimum and Maximum coefficients, 38  
 MMULT, 205  
 MOD, 205  
 Model Reduction, 59  
 Model Type, 38  
 Models  
   Non-optimization, 221  
   with Integer Restrictions, 2  
 MODERR, 432  
 Multi-Period Inventory Management, 327  
 Multi-period Model, 278  
 Multiple Optima, 117, 123, 375  
 Multi-stage, 225  
 Multistart Attempts, 66

## N

NAME, 433  
 Network installation, 4  
   errors, 373  
 Network models, 270  
 Newsvendor, 233  
 No best cell warning, 221  
 No Feasible Solution Found, 221  
 NOADJ, 416  
 NOBEST, 435  
 NOCONST, 435  
 Node, 270  
 Node Selection, 78  
 None Best, 25  
 Nonlinear, 134  
   Expressions, 214  
   Initial Values, 223  
   Magnitude of Model, 223  
   Modeling Guidelines, 223  
   Models, 63, 220, 223  
   Models Starting Point, 63  
   Optimization, 215  
   Scaling the model, 223  
   Solver Options Dialog Box, 61  
   Undefined Regions, 223  
 Non-optimization Models, 2, 221  
 NORMINV, 205  
 NORMSDIST, 205  
 NOT function, 207

NPV, 205  
 NUMERICAL ERROR, 221

**O**

Objective, 14, 25  
 Objective Value, 39  
 Omit Cells, 175  
 Omit command  
   what not to omit, 125  
   what to omit, 125  
 OMIT names in workbook, 124  
 OMITTED, 436  
 Operators, 205–12  
 Optimality, 66, 76  
 Optimality conditions, 220  
 Optimality Tolerance, 63  
 Optimization, 2  
   Models, 2  
   Nonlinear, 215  
   optima, 220  
 Optimum  
   Global, 215  
   Local, 215  
   Locally, 220  
 Options and Solvers, 41  
 Options command, 50  
 Options...|General, 51  
 Options...|Global Solver, 65  
 Options...|Integer Pre-Solver, 68  
 Options...|Integer Solver, 73  
 Options...|Linear Solver, 58  
 Options...|Nonlinear Solver, 61  
 Options...|Reset to Default, 109  
 Options...|Stochastic Solver, 88  
 OR function, 207

**P**

Parameters Dialog Box, 130  
 Partial, 60  
 Personal Version, 134  
 PI, 205  
 Pipeline Optimization, 369  
 PIPELINE.XLSX, 369  
 Plant Location, 72, 344  
 PLANTLOC.XLSX, 344  
 PMIXMAC.XLS, 150  
 PMIXMAC.XLSM, 330  
 PORTCOST.XLSX, 292  
 Portfolio  
   Minimizing Downside Risk, 295

Scenario Model, 298  
 Selection, 288  
   With Transaction Cost, 292  
 PORTSCEN.XLSX, 298  
 POSD, 28  
 POSD-SDP, 28  
 Positive Definite, 28  
 Positive Semi-Definite function, 28  
 Presolve, 62  
 Pricing, 59  
 PRICING.XLSX, 320  
 Primal, 75  
 Primal Pricing, 60  
 Probing Level, 69  
 PRODMIX.XLSX, 330  
 Product Mix, 330  
 Professional Version, 134  
 Profit, 295, 320, 334  
 Protect Sheet, 23, 28, 146  
 Put Option, 390  
 PUTOPTION.XLSX, 390

**Q**

quadratic cone, 252  
 Quadratic Recognition, 62  
 QUAPREC, 437

**R**

RAM, 3  
 Ranges, 117  
 Reasonable Bounding Constraints, 223  
 Recourse models, 227  
 Reduced Cost, 114  
 Refers to, 44  
 Register, 138  
 Relationships, 224  
 Relative, 74  
 Relative Limit, 72  
 Relative Violation, 67  
 Remove adjustable, 23  
 Restrictions, 224  
 Return, 278, 292  
 RHS, 27  
 Right Hand Side, 27  
 Risk, 292, 295, 298  
 Runtime  
   Concerns, 44  
   Errors, 407  
 RUNTIME, 438  
 runtime limit, 52

## S

- Sales, 304
- SAMPLEWB.XLSX, 317
- Sampling, 317
- Savage, S., 2
- Scale Model, 59
- Scaling the Model, 223
- Scheduling Model, 349, 353, 360
- SDP, 28
- SEASON.XLSX, 304
- Seasonal Sales Factoring, 304
- Selective Constraint Evaluation, 62
- Semi-continuous variable, 48
- Semi-variance, 298
- Set Adjustable cells, 16
- Shadow Price, 112
- Shipping Cost Reduction, 373
- SHIPPING.XLSX, 373
- SIMXPO.XLSX, 308
- SIN, 205
- SINH, 205
- SLP Direction, 62
- Smooth vs. Nonsmooth Expressions, 218
- SMOOTH.XLSX, 308
- SOCP, 251
- Solution Outcomes, 220
- Solution Status, 38, 220
  - INFEASIBLE, 221
  - Locally Optimal, 220
  - NUMERICAL ERROR, 221
  - Optimal, 215
  - UNBOUNDED, 221
- Solution Time, 39
- Solve command, 33
- Solver decides, 78
- Solver Method, 59
- Solver Type, 39
- SOLVERGOP, 438
- SOLVERR, 439
- Solving, 33
  - Interrupting, 220
  - no feasible solution found, 221
  - optimality conditions, 220
  - Unbounded, 221
- Solving Second Order Cone Programs, 251
- SOS1, 45
- SOS2, 46
- SOS3, 46
- SPCONFLICT, 440
- SPCORR, 441
- SPDIST1, 441
- SPDIST2, 442
- SPDIST3, 442
- Special Ordered Set, 45
- Specified, 4
- Specify Constraints, 16
- SPERR, 443
- SPHIST, 444
- SPRAND, 444
- SPREP, 445
- SPSTSC, 446
- SPVAR, 446
- SQRT, 205
- Staff Scheduling, 349
- Staff Scheduling Preferred Assignment, 353
- Staff Scheduling Two Stage Fixed Shift, 360
- STAFF.XLSX, 349
- Standard Deviation, 288
- Starting What'sBest!, 7
- Statistical functions, Error! Not a valid bookmark in entry on page 208
- Steepest Edge, 60, 63
- Stochastic, 225
- Stochastic Monte Carlo Sampling, 242
- STRARG, 447
- Stratified Sampling, 317
- Strictly convex/concave, 218
- String Support
  - Maximum String Length, 128
- STRLIST, 447
- Strong Branch, 78
- STRRES, 448
- Sub or Function not defined, 147, 406
- SUM, 205
- SUMIF, 207, 448
- SUMIFWBSOLVER.XLS, 449
- SUMPRODUCT, 205
- Supported Functions and Operators, 205
- System Requirements, 3

## T

- TEMPFILE, 449
- Textbook, 2
- The ABC's, 21
- The Building Block Method, 334
- Time to Relative, 77
- Tolerance command, 78
- Tolerances, 77
- Toolbar, 7
- ToolBar command, 135
- Tools|Add-ins, 4
- Tools|Macros, 147

Tools|References, 147  
Trademarks, 2  
Traffic Congestion Cost Minimization, 376  
TRAFFIC.XLSX, 376  
TRANSPOSE, 205  
Trend, 304  
Trial Version, 134  
Tries, 39  
Truck Loading, 379  
TRUCK.XLSX, 379  
TRUE, 205  
Tutorial, 10  
    on the VBA Interface, 147  
Types, 72

## U

UNBOUNDED, 221, 449  
Uncertainty, 225  
UNDEFREF, 450  
Upper Range, 111  
Usage Guidelines  
    for Dual values, 112  
    for Omit, 125  
Use of Bound, 67

## V

Valid Ranges for Dual Values, 117  
Variable Bounds, 67  
Variables, 134  
    integer, 2, 44  
Variance, 298  
VBA, 145, 147, 151, 170, 175  
VBA Interface  
    Procedures, 151  
VBA Interface Tutorial, 147  
Visual Basic  
    Editor, 147  
    for applications (VBA), 143–204  
VLOOKUP, 207, 431  
VLOOKUPWBSOLVER.XLS, 431

## W

Warm Start, 75  
Waste Minimization in Stock Cutting, 339  
WB formula, 28  
WB! Menu, 4, 7, 21  
WB! Solution, 36, 56  
WB! Status, 36, 55  
WB!\_Histogram, 58

WB!\_Stochastic, 58  
wbAddAdjustableStyle, 152  
wbAddBestStyle, 152  
wbAddWBMenu, 152  
wbAdjust, 153  
wbBest, 154  
WBBIN, 155  
WBCARDFORM, 451  
wbConstraint, 156  
wbConstraintPOSD, 157  
wbDeleteReports, 158  
wbDeleteWBMenu, 158  
WBDUAL Formula, 110  
wbDualValue, 159  
WBDUFORM, 451  
WBBERLANG, 208  
WBBERLANG\_B, 208  
wbError, and Error Codes, 160  
WBEXPOINV, 209  
WBFREE, 168  
WBINNERPRODUCT, 209  
WBINT, 169  
wbInteger, 170  
wbIntegerCard, 171  
wbIntegerSemic, 172  
wbIntegerSolverKBestReport, 174  
wbIntegerSos, 173  
WBLOFORM, 452  
WBLOGISTIC, 209  
WBLOGISTICDENS, 210  
WBLOGISTICINV, 210  
WBLOWER Formula, 110  
WBMULTINV, 210  
WBNORMSL, 211  
WBOMIT, 175  
WBPOSD, 28  
wbResetOptionsToDefault, 176  
WBSEMICFORM, 453  
wbSetFunctionSupport, 176  
wbSetGeneralOptions, 177  
wbSetGlobalOptions, 181  
wbSetIntegerOptions, 183  
wbSetIntegerPreSolverOptions, 186  
wbSetLinearOptions, 189  
wbSetNonlinearOptions, 190  
wbSetStochasticOptions, 193  
wbSetStochasticSupport, 195  
wbSetStringSupport, 195  
wbSolve, 196  
WBSOSFORM, 454  
WBSP\_MEAN, 101  
WbStochasticChanceConstrained, 198  
WbStochasticFunction, 200, 201

---

---

wbStochasticReport, 202  
wbStochasticStageScenario, 203  
WBTRIAINV, 211  
WBUNIFINV, 212  
wbUpdateLinks, 204  
WBUPFORM, 454  
WBUPPER Formula, 110  
WBxxx, 41  
WEIBULL, 205  
What If projections, 11, 18  
Working while Solving, 19  
Worst Bound, 67, 78

## X

XYZ production problem  
adjustable cell ranges, 12  
after optimization, 18  
best cell, 13  
what's best if, 18  
XYZ.XLS, 10  
XYZVBA.XLSM, 147